

# 承 認 書

## SPECIFICATION FOR APPROVAL

Customer Name: 2144

Description Part No.: \_\_\_\_\_

Customer Part No.: \_\_\_\_\_

Sample No.: \_\_\_\_\_

DDY Part No.: SFEK252010S-

DRAWING		
MADE	CHECKED	APPROVED
王海玲	赵万虎	肖中华
DATE: 2023年8月24日		

CUSTOMER APPROVE



惠 州 市 德 立 电 子 有 限 公 司

HUI ZHOU DE LI ELECTRONICS CO., LTD

廣 東 省 博 羅 縣 洲 際 工 業 園 梅 園 三 路

NO.3 MEI YUAN ROAD,ZHOU JI INDUSTRIAL AREA,BOLUO COUNTY GUANGDONG

電話：15970768093 13640935893

傳真：0752-6207969

郵編：516100

Http: [www.ddycoils.com](http://www.ddycoils.com)





### 1. Scope

This specification applies to the SFEK252010 Series of wire wound SMD power inductor.

### 2.PRODUCT IDENTIFICATION

SFEK 252010 - 1R5 □ - □

(1) (2) (3) (4) (5)

(1) .Series name (产品品名) (2) .Dimensions (产品尺寸)

(3) .Inductance value (电感值) (4) .Tolerance (误差值)

1R5: 1.5μH 221: 220μH

M: ±20%; N: ±30%

(5) .Environmental status (环保状态)

LF- Lead free; HF-Halogen free;

FP-Free red phosphor.

### 3. Electrical Characteristics

Please refer to Item 5.

- 1). Operating temperature range (individual chip without packing): -40°C ~ +125°C ;
- 2). Storage temperature range (packaging conditions): -40°C ~ +85°C and RH 70% (Max.);
- 3). Irms:DC current that causes the temperature rise ( $\Delta T = 40^\circ C$ ) from 20°C ambient;
- 4). Isat: DC current at which the inductance drops approximate 30% from its value without current;
- 5). All test data is referenced to 20°C ambient;
- 6). Rated current: Isat or Irms, whichever is smaller;
- 7). Absolute maximum voltage: DC 25V;

### 4. Shape and Dimensions (Unit:mm)

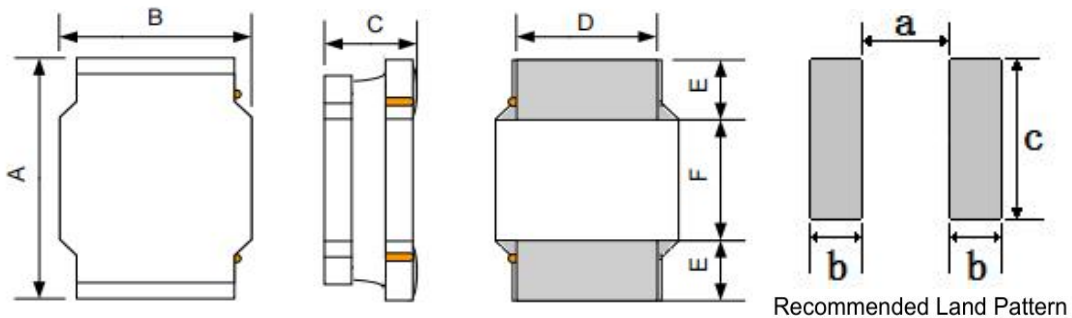

NO	Series	A	B	C	D	E	F	a Typ.	b Typ.	c Typ.
1	SFEK252010	2.5±0.3	2.0±0.3	1.0 Max.	2.0±0.2	0.8 Typ.	0.9 Typ.	0.70	1.00	2.2



### 5. Electrical Characteristics

NO	Part Number	Inductance	DC Resistance		Isat(A)		Irms(A)		Marking
		1MHz/0.1V	Max.	Typ.	Max.	Typ.	Max.	Typ.	
	Units	(uH)	Ω	Ω	A	A	A	A	
1	<input type="checkbox"/> SFEK252010S-R24N-HF	0.24±30%	0.033	0.025	6.10	7.10	3.70	4.50	N/A
2	<input type="checkbox"/> SFEK252010S-R33N-HF	0.33±30%	0.039	0.033	4.80	5.50	3.50	4.05	N/A
3	<input type="checkbox"/> SFEK252010S-R47N-HF	0.47±30%	0.045	0.040	4.40	5.20	3.20	3.60	N/A
4	<input type="checkbox"/> SFEK252010S-R68N-HF	0.68±30%	0.059	0.049	3.20	3.60	2.75	3.20	N/A
5	<input type="checkbox"/> SFEK252010S-1R0N-HF	1.0±30%	0.085	0.080	3.10	4.00	2.20	2.60	N/A
6	<input type="checkbox"/> SFEK252010S-1R5N-HF	1.5±30%	0.106	0.090	2.60	3.00	2.00	2.30	N/A
7	<input type="checkbox"/> SFEK252010S-2R2M-HF	2.2±20%	0.155	0.129	1.90	2.20	1.50	1.80	N/A
8	<input type="checkbox"/> SFEK252010S-3R3M-HF	3.3±20%	0.252	0.210	1.60	1.80	1.20	1.40	N/A
9	<input type="checkbox"/> SFEK252010S-4R7M-HF	4.7±20%	0.340	0.290	1.30	1.50	1.00	1.10	N/A
10	<input type="checkbox"/> SFEK252010S-6R8M-HF	6.8±20%	0.480	0.380	1.00	1.15	0.95	1.00	N/A
11	<input type="checkbox"/> SFEK252010S-100M-HF	10±20%	0.740	0.700	0.90	1.00	0.65	0.75	N/A
12									
13									
14									
15									
16									
17									
18									
19									
20									

※Design as Customer's Requested Specifications. (可按顾客的特殊需求设计)



## 6. Structure (The structure of product.)

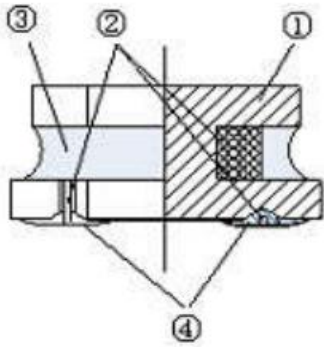

NO	Components	Material
①	Core	soft magnetic metal
②	Wire	Polyurethane system enameled copper wire
③	Magnetic Glue	Epoxy resin and magnetic powder
④	Plating	AgNiSn or FeNiCu + Sn Alloy

## 7. PACKAGING(unit: mm)

1.包装类型：编带装

2.包装尺寸：

13" 盘

7" 盘

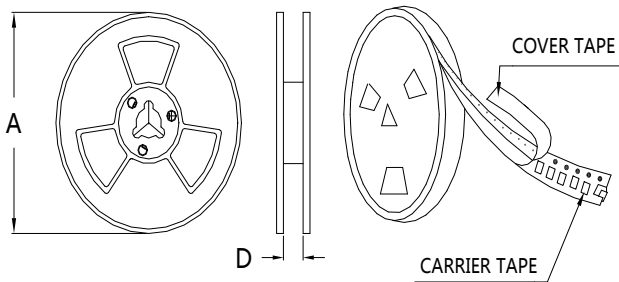

	13" 盘	7" 盘
A	$\Phi 330 \pm 2.0$	$\Phi 178 \pm 2.0$
D	8.5	

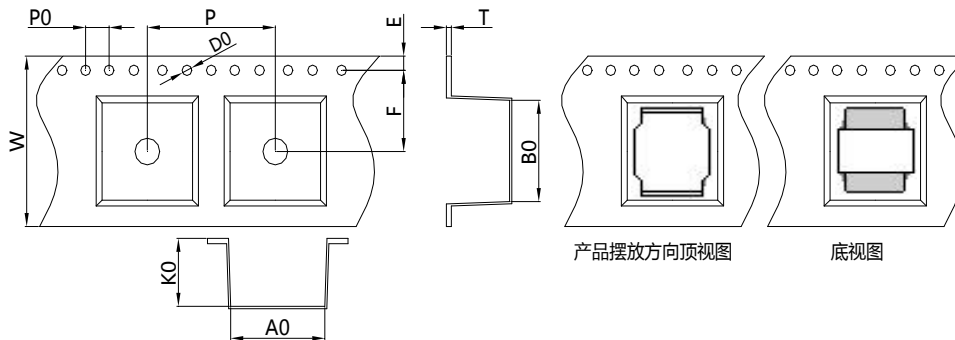

Size	Item	W	A0	B0	K0	P	T	E	F	D0	P0
252010	(mm)	$8.00 \pm 0.3$	$2.35 \pm 0.2$	$2.65 \pm 0.2$	$1.40 \pm 0.1$	$4.00 \pm 0.1$	$0.25 \pm 0.1$	$1.75 \pm 0.1$	$3.50 \pm 0.1$	$1.50 \pm 0.1$	$4.00 \pm 0.2$

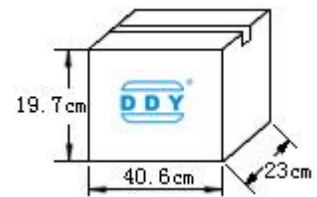
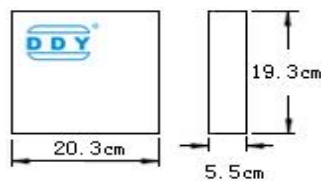

每卷 2000 Pcs

每盒 4卷,共 8000 Pcs

每箱 6盒,共 48000 Pcs

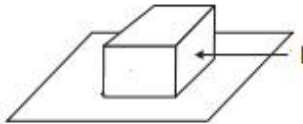

**8. RELIABILITY TEST**

No.	TEST ITEM	SPECIFICATION	TEST CONDITION
1	High temperature Storage test	1. No significant defects in appearance. 2. $\Delta L/L \leq 10\%$ 3. $\Delta DCR/DCR \leq 10\%$	Temperature: $125^{\circ}\text{C} \pm 5^{\circ}\text{C}$ (N: Follow the product specification for the setting.) Time : $96 \pm 2$ hours Place the samples for one hour at room temperature and test them within two hours
2	Low temperature Storage test	1. No significant defects in appearance. 2. $\Delta L/L \leq 10\%$ 3. $\Delta DCR/DCR \leq 10\%$	Temperature: $-40^{\circ}\text{C} \pm 5^{\circ}\text{C}$ (M: Follow the product specification for the setting) Time : $96 \pm 2$ hours Place the samples for one hour at room temperature and test them within two hours.
3	Humidity test	1. No significant defects in appearance. 2. $\Delta L/L \leq 10\%$ 3. $\Delta DCR/DCR \leq 10\%$	Temperature: $40 \pm 2^{\circ}\text{C}$ , Humidity: $93 \pm 3\% \text{RH}$ Time : $96 \pm 2$ hours Place the samples for one hour at room temperature and test them within two hours
4	Solderability test	Terminals must have 95% minimum solder coverage	1. Dip pads in flux then dip in solder pot at $245 \pm 5^{\circ}\text{C}$ for 5 second. 2. Solder: lead free 3. Flux: rosin flux
5	Heat endurance of flow soldering	1. No significant defects in appearance. 2. $\Delta L/L \leq 10\%$ 3. $\Delta DCR/DCR \leq 10\%$	1. Refer to the above reflow curve and go through the reflow for twice. 2. The peak temperature : $260 + 0 / - 5^{\circ}\text{C}$
6	Vibration test	1. No significant defects in appearance. 2. No short and no open.	Apply frequency 10~55~10Hz and amplitude 1.5mm, 1 min/cycle in X Y and Z direction for 2 hours each. (total 6 hours)
7	Terminal strength push test	1. Applied force: 10N Duration: 10sec 2. Solder paste thickness: 0.12mm 3. Meet the above requirements without any loose termina	Solder the test samples to the PCB through $245^{\circ}\text{C}$ reflow, apply a standard force on the side of the test samples for 10 seconds. 



## 9. SOLDERING CONDITIONS

Applicable soldering process to the products is refl.

### 9.1 Soldering Materials

(1) Solder: Sn-3.0Ag-0.5Cu

(2) Flux: Use rosin-based flux, but not strongly acidic flux (with chlorine exceeding 0.2wt%). Do not use water-soluble flux.

### 9.2 Reflow Soldering Profile

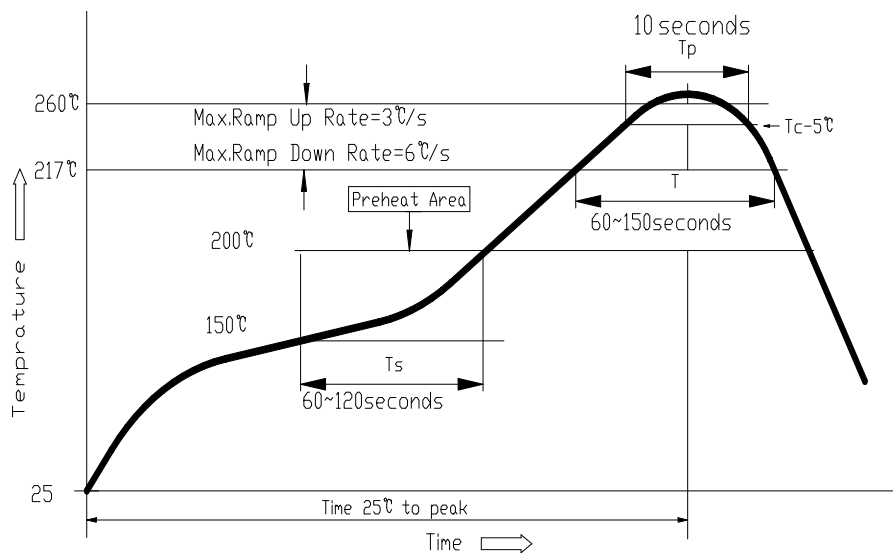

### 9.3 Soldering Iron

Reworking with electric soldering iron must preheating at 150°C for 1 minute is required, and do not directly touch the core with the tip of the soldering iron. The reworking soldering conditions are as follows.

- ① Temperature of soldering iron tip: 350°C;
- ② Soldering iron power output: ≤30W;
- ③ Diameter of soldering iron end: ≤1.0mm;
- ④ Soldering time: <3 s



## X-ON Electronics

Largest Supplier of Electrical and Electronic Components

*Click to view similar products for [Fixed Inductors](#) category:*

*Click to view products by [DDY](#) manufacturer:*

Other Similar products are found below :

[CR32NP-100KC](#) [70F224AI](#) [MHQ1005P10NJ](#) [MHQ1005P1N0S](#) [MHQ1005P2N4S](#) [MHQ1005P3N6S](#) [MHQ1005P5N1S](#) [MHQ1005P8N2J](#)  
[PE-53601NL](#) [PE-53602NL](#) [PG0936.113NLT](#) [9220-20](#) [9310-16](#) [PM06-2N7](#) [PM06-39NJ](#) [A01TK](#) [1206CS-471XJ](#) [HC2-R47-R](#) [HC8-1R2-R](#)  
[HCF1305-3R3-R](#) [1206CS-151XG](#) [RCH664NP-4R7M](#) [RCP1317NP-391L](#) [DH2280-4R7M](#) [DS1608C-106](#) [B10TJ](#) [B82498B3101J000](#) [ELJ-](#)  
[RE27NJF2](#) [1812CS-153XJ](#) [1812CS-183XJ](#) [1812CS-223XJ](#) [1812LS-104XJ](#) [1812LS-105XJ](#) [1812LS-124XJ](#) [1812LS-154XJ](#) [1812LS-223XJ](#)  
[1812LS-224XJ](#) [1812LS-563XJ](#) [1812LS-683XJ](#) [1812LS-824XJ](#) [NIN-FB101JTR110F](#) [NIN-FB471JTR62F](#) [NIN-FC1R5JTR220F](#) [NIN-](#)  
[HCR15JTRF](#) [NIN-HCR33JTRF](#) [NIN-HDR22JTRF](#) [NIN-HDR82JTRF](#) [NIN-HK2N7STRF](#) [NIN-PA150KTR370F](#) [NIN-PB100KTR550F](#)