

# 承 認 書

## SPECIFICATION FOR APPROVAL

Customer Name: \_\_\_\_\_ 2144 \_\_\_\_\_

Description Part No.: \_\_\_\_\_

Customer Part No.: \_\_\_\_\_

Sample No.: \_\_\_\_\_

DDY Part No.: \_\_\_\_\_ SFEK4012A- \_\_\_\_\_

DRAWING		
MADE	CHECKED	APPROVED
王海玲	赵万虎	肖中华
DATE: 2023年9月7日		

CUSTOMER APPROVE



惠州市德立电子有限公司

HUI ZHOU DE LI ELECTRONICS CO., LTD

廣東省博羅縣洲際工業園梅園三路

NO.3 MEI YUAN ROAD,ZHOU JI INDUSTRIAL AREA,BOLUO COUNTY GUANGDONG

電話：15970768093 13640935893

傳真：0752-6207969

郵編：516100

Http: www.ddycoils.com



Version of Changed Record				
DATE	REV	CHANGED CONTENTS	DRAFT	APPROVED
2023/9/7	A	新版发行	王海玲	肖中华
<b>* Special notes:</b> <b>This product is non-vehicle certified.</b>				



### 1. Scope

This specification applies to the SFEK4012 Series of wire wound SMD power inductor.

### 2.PRODUCT IDENTIFICATION

SFEK 4012 □ - 1R5 □ - □  
(1) (2) (3) (4) (5) (6)

- (1) .Series name (产品品名)
- (2) .Dimensions (产品尺寸)
- (3) .Appearance shape (产品形状)  
A: dodecagon (十二边形) : B: octagon (八边形)
- (4) .Inductance value (电感值)  
1R5: 1.5μH 221: 220μH
- (5) Tolerance (误差值)  
M: ±20%; N: ±30%
- (6) .Environmental status (环保状态)  
LF- Lead free; HF-Halogen free;  
FP-Free red phosphor.

### 3. Electrical Characteristics

Please refer to Item 5.

- 1). Operating temperature range (individual chip without packing): -40°C ~ +125°C ;
- 2). Storage temperature range (packaging conditions): -40°C ~ +85°C and RH 70% (Max.);
- 3). Irms:DC current that causes the temperature rise ( $\Delta T = 40^{\circ}C$ ) from 20°C ambient;
- 4). Isat: DC current at which the inductance drops approximate 30% from its value without current;
- 5). All test data is referenced to 20°C ambient;
- 6). Rated current: Isat or Irms, whichever is smaller;
- 7). Absolute maximum voltage: DC 25V;

### 4. Shape and Dimensions (Unit:mm)

shape: A

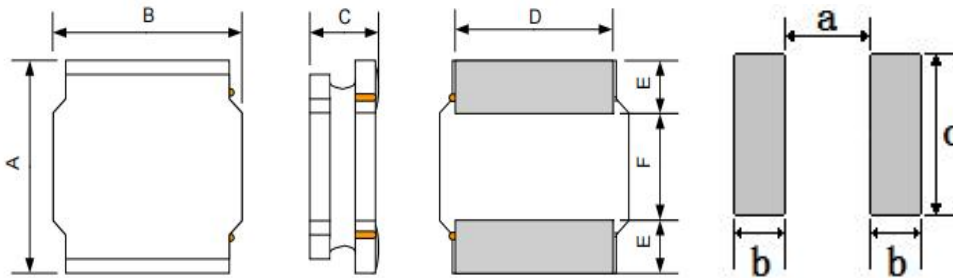

Recommended Land Pattern

Series	A	B	C	D	E	F	a Typ.	b Typ.	c Typ.
SFEK4012A	4.0±0.2	4.0±0.2	1.2 Max.	3.4±0.2	1.0 Typ.	2.0 Typ.	1.80	1.20	3.6



**5. Electrical Characteristics**

NO.	Part Number	Inductance	DC Resistance		Isat(A)		Irms(A)		Marking
		1MHz/0.1V	Max.	Typ.	Max.	Typ.	Max.	Typ.	
	Units	( $\mu$ H)	$\Omega$	$\Omega$	A	A	A	A	
1	<input type="checkbox"/> SFEK4012A-R47N-HF	0.47 $\pm$ 30%	0.042	0.033	6.00	7.50	4.20	5.20	N/A
2	<input type="checkbox"/> SFEK4012A-R68N-HF	0.68 $\pm$ 30%	0.048	0.037	5.00	5.60	4.00	4.70	N/A
3	<input type="checkbox"/> SFEK4012A-1R0N-HF	1.0 $\pm$ 30%	0.066	0.053	4.50	5.30	3.60	4.20	N/A
4	<input type="checkbox"/> SFEK4012A-1R5N-HF	1.5 $\pm$ 30%	0.070	0.056	3.90	4.50	3.20	3.90	N/A
5	<input type="checkbox"/> SFEK4012A-2R2M-HF	2.2 $\pm$ 20%	0.102	0.082	2.50	2.80	2.30	2.80	N/A
6	<input type="checkbox"/> SFEK4012A-3R3M-HF	3.3 $\pm$ 20%	0.145	0.096	2.30	2.60	2.20	2.50	N/A
7	<input type="checkbox"/> SFEK4012A-4R7M-HF	4.7 $\pm$ 20%	0.187	0.150	2.30	2.60	1.90	2.20	N/A
8	<input type="checkbox"/> SFEK4012A-6R8M-HF	6.8 $\pm$ 20%	0.255	0.188	1.60	2.20	1.60	1.90	N/A
9	<input type="checkbox"/> SFEK4012A-100M-HF	10.0 $\pm$ 20%	0.408	0.325	1.40	1.80	1.10	1.50	N/A
10	<input type="checkbox"/> SFEK4012A-150M-HF	15.0 $\pm$ 20%	0.632	0.506	1.20	1.60	0.90	1.25	N/A
11	<input type="checkbox"/> SFEK4012A-220M-HF	22.0 $\pm$ 20%	0.763	0.611	1.10	1.35	0.75	0.95	N/A

※Design as Customer's Requested Specifications. (可按顾客的特殊需求设计)



## 6. Structure (The structure of product.)

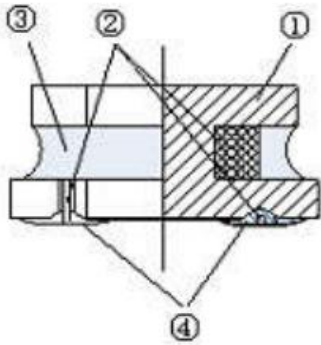

NO	Components	Material
①	Core	soft magnetic metal
②	Wire	Polyurethane system enameled copper wire
③	Magnetic Glue	Epoxy resin and magnetic powder
④	Plating	AgNiSn or FeNiCu + Sn Alloy

## 7. PACKAGING(unit: mm)

1.包装类型：编带装

2.包装尺寸：



13" 盘



7" 盘

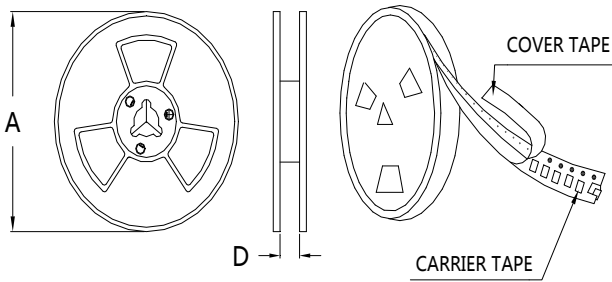

	13" 盘	7" 盘
A	$\Phi 330 \pm 2.0$	$\Phi 178 \pm 2.0$
D	12.5	

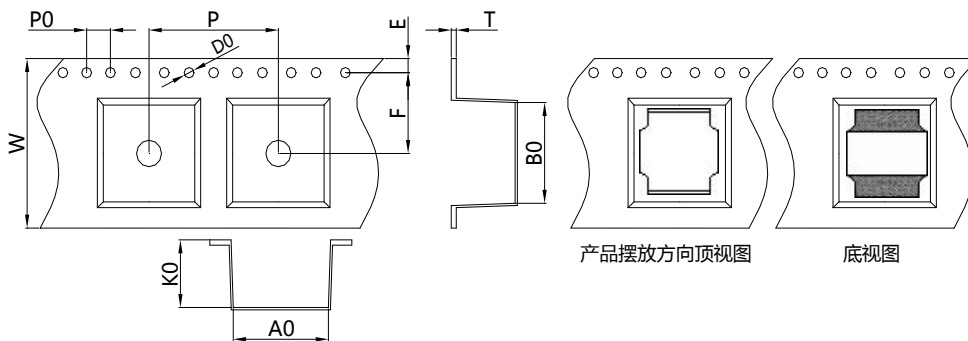

Item	W	A0	B0	K0	P	T	E	F	D0	P0
(mm)	$12.0 \pm 0.3$	$4.4 \pm 0.2$	$4.4 \pm 0.2$	$1.4 \pm 0.1$	$8.0 \pm 0.3$	$0.3 \pm 0.1$	$1.75 \pm 0.1$	$5.5 \pm 0.2$	$1.5 \pm 0.1$	$4.0 \pm 0.2$

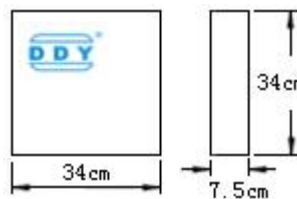

每卷 4500 Pcs

每盒 4卷,共 18000 Pcs

每箱 3盒,共 54000 Pcs

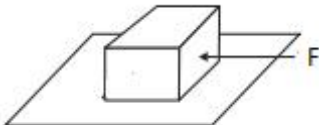

8. RELIABILITY TEST			
No.	TEST ITEM	SPECIFICATION	TEST CONDITION
1	High temperature Storage test	1. No significant defects in appearance. 2. $\Delta L/L \leq 10\%$ 3. $\Delta DCR/DCR \leq 10\%$	Temperature: $125^{\circ}\text{C} \pm 5^{\circ}\text{C}$ (N: Follow the product specification for the setting.) Time : $96 \pm 2$ hours Place the samples for one hour at room temperature and test them within two hours
2	Low temperature Storage test	1. No significant defects in appearance. 2. $\Delta L/L \leq 10\%$ 3. $\Delta DCR/DCR \leq 10\%$	Temperature: $-40^{\circ}\text{C} \pm 5^{\circ}\text{C}$ (M: Follow the product specification for the setting) Time : $96 \pm 2$ hours Place the samples for one hour at room temperature and test them within two hours.
3	Humidity test	1. No significant defects in appearance. 2. $\Delta L/L \leq 10\%$ 3. $\Delta DCR/DCR \leq 10\%$	Temperature: $40 \pm 2^{\circ}\text{C}$ , Humidity: $93 \pm 3\% \text{RH}$ Time : $96 \pm 2$ hours Place the samples for one hour at room temperature and test them within two hours
4	Solderability test	Terminals must have 95% minimum solder coverage	1. Dip pads in flux then dip in solder pot at $245 \pm 5^{\circ}\text{C}$ for 5 second. 2. Solder: lead free 3. Flux: rosin flux
5	Heat endurance of flow soldering	1. No significant defects in appearance. 2. $\Delta L/L \leq 10\%$ 3. $\Delta DCR/DCR \leq 10\%$	1. Refer to the above reflow curve and go through the reflow for twice. 2. The peak temperature : $260 + 0 / - 5^{\circ}\text{C}$
6	Vibration test	1. No significant defects in appearance. 2. No short and no open.	Apply frequency 10~55~10Hz and amplitude 1.5mm, 1 min/cycle in X Y and Z direction for 2 hours each. (total 6 hours)
7	Terminal strength push test	1. Applied force: 10N Duration: 10sec 2. Solder paste thickness: 0.12mm 3. Meet the above requirements without any loose termina	Solder the test samples to the PCB through $245^{\circ}\text{C}$ reflow, apply a standard force on the side of the test samples for 10 seconds. 



## 9. SOLDERING CONDITIONS

Applicable soldering process to the products is refl.

### 9.1 Soldering Materials

- (1) Solder: Sn-3.0Ag-0.5Cu
- (2) Flux: Use rosin-based flux, but not strongly acidic flux (with xhlorine exceeding 0.2wt%). Do not use water-soluble flux.

### 9.2 Reflow Soldering Profile

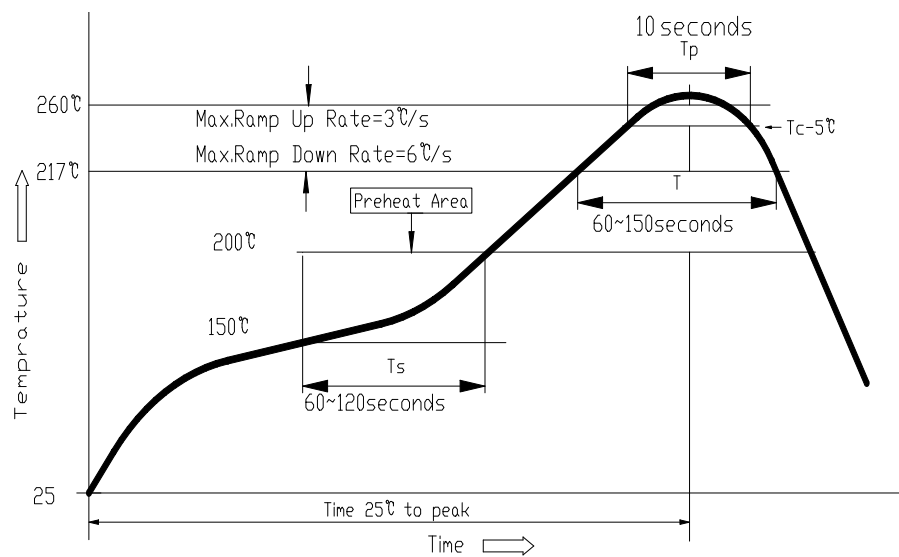

### 9.3 Soldering Iron

Reworking with electric soldering iron must preheating at 150°C for 1 minute is required, and do not directly touch the core with the tip of the soldering iron. The reworking soldering conditions are as follows.

- ① Temperature of soldering iron tip: 350°C;
- ② Soldering iron power output:  $\leq 30W$ ;
- ③ Diameter of soldering iron end:  $\leq 1.0mm$ ;
- ④ Soldering time:  $< 3 s$



## X-ON Electronics

Largest Supplier of Electrical and Electronic Components

*Click to view similar products for [Fixed Inductors](#) category:*

*Click to view products by [DDY](#) manufacturer:*

Other Similar products are found below :

[CR32NP-100KC](#) [70F224AI](#) [MHQ1005P10NJ](#) [MHQ1005P1N0S](#) [MHQ1005P2N4S](#) [MHQ1005P3N6S](#) [MHQ1005P5N1S](#) [MHQ1005P8N2J](#)  
[PE-53601NL](#) [PE-53602NL](#) [PG0936.113NLT](#) [9220-20](#) [9310-16](#) [PM06-2N7](#) [PM06-39NJ](#) [A01TK](#) [1206CS-471XJ](#) [HC2-R47-R](#) [HC8-1R2-R](#)  
[HCF1305-3R3-R](#) [1206CS-151XG](#) [RCH664NP-4R7M](#) [RCP1317NP-391L](#) [DH2280-4R7M](#) [DS1608C-106](#) [B10TJ](#) [B82498B3101J000](#) [ELJ-](#)  
[RE27NJF2](#) [1812CS-153XJ](#) [1812CS-183XJ](#) [1812CS-223XJ](#) [1812LS-104XJ](#) [1812LS-105XJ](#) [1812LS-124XJ](#) [1812LS-154XJ](#) [1812LS-223XJ](#)  
[1812LS-224XJ](#) [1812LS-563XJ](#) [1812LS-683XJ](#) [1812LS-824XJ](#) [NIN-FB101JTR110F](#) [NIN-FB471JTR62F](#) [NIN-FC1R5JTR220F](#) [NIN-](#)  
[HCR15JTRF](#) [NIN-HCR33JTRF](#) [NIN-HDR22JTRF](#) [NIN-HDR82JTRF](#) [NIN-HK2N7STRF](#) [NIN-PA150KTR370F](#) [NIN-PB100KTR550F](#)