

标记 REV. LTR.	日期 DATE	版别 REV.	变更内容 REVISION
-----------------	------------	------------	------------------

姓名  
NAME

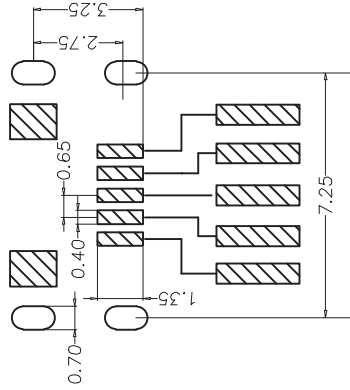
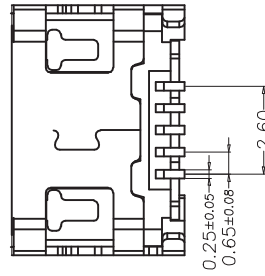
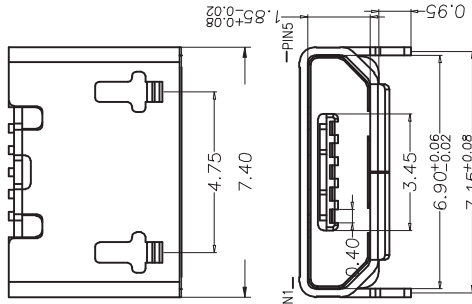
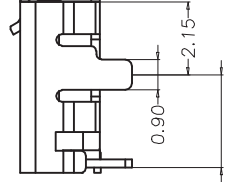
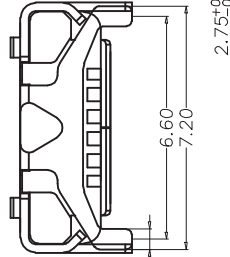
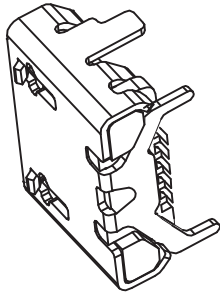
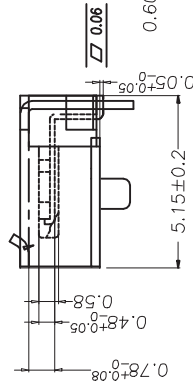
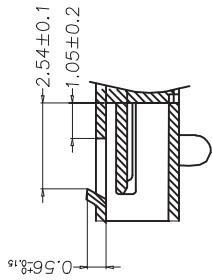

规格说明: Specifications:

电气特性: Electrical:

- 1. 额定电流: Current Rating  
1.0A/contact terminal
- 2. 额定电压: Voltage Rating  
30V DC
- 3. 接触阻抗: Contact Resistance  
50 milliohms MAX
- 4. 耐压: Dielectric Withstanding Voltage:  
300 V AC AT Sea Level
- 5. 绝缘阻抗: Insulation Resistance:  
100MEGA ohms MIN

物理性能: Mechanical:

- 1. 插拔力: Connector Mate and Umate Force  
Mate force: 3.0kgf (MAX)  
Umate force: 0.7kgf (MIN)
- 2. 端子保持力: Terminal Retention  
0.5kgf (MIN)

原材料: Material:

- 1. 塑胶: Housing:  
Hig Temperature Ternmaplastics,  
UI 94V-0 LQP Black
  - 2. 端子: Contact: Copper Alloy H65 eh
  - 3. 外壳: Shell: H 65 eh
- 电镀: Finish:
- 1. 端子: Contact: Plated Gold in Mating Area;  
Tin On Solder Tails
  - 2. 外壳: Shell:  
Nickel Plating (能过炉自动上锡)

QUALITY	I	II	III
X.XX	±0.01	±0.02	±0.03
X.XX	±0.03	±0.05	±0.08
X.XX	±0.05	±0.10	±0.12
X	±0.10	±0.15	±0.20
ALBLE	±0.05	±1.0°	±2.0°

表面处理 PLATING	
材料 MATERIAL	
材料 MATERIAL	

品名 TITLE	料号 P/N	图号 D.W.	图名 D.W.
品名 TITLE	料号 P/N	图号 D.W.	图名 D.W.
品名 TITLE	料号 P/N	图号 D.W.	图名 D.W.
品名 TITLE	料号 P/N	图号 D.W.	图名 D.W.
品名 TITLE	料号 P/N	图号 D.W.	图名 D.W.

品名 TITLE	料号 P/N	图号 D.W.	图名 D.W.
品名 TITLE	料号 P/N	图号 D.W.	图名 D.W.
品名 TITLE	料号 P/N	图号 D.W.	图名 D.W.
品名 TITLE	料号 P/N	图号 D.W.	图名 D.W.
品名 TITLE	料号 P/N	图号 D.W.	图名 D.W.

姓名  
NAME

姓名  
NAME

姓名  
NAME

姓名  
NAME

姓名  
NAME

姓名  
NAME

姓名  
NAME

姓名  
NAME

## X-ON Electronics

Largest Supplier of Electrical and Electronic Components

*Click to view similar products for [USB Connectors](#) category:*

*Click to view products by [DEALON](#) manufacturer:*

Other Similar products are found below :

[950](#) [A-USB B-TOP-C](#) [MUSBA511N5](#) [MUSBC111M5](#) [MUSBD11135](#) [17-200721](#) [217450-1](#) [KMBVX-TH-5S-B30](#) [896-30-004-00-000000](#)  
[KUSBX-AS2N-W](#) [KUSBX-SMT2AP1S-W30](#) [935](#) [957](#) [30-498-6](#) [SK-60A-2](#) [1734082-1](#) [30-1574](#) [30-470](#) [30-489](#) [30-541](#) [30-572-3](#) [A-USB](#)  
[A-2P-C](#) [MIKROE-1451](#) [USBFTV2PEM2G](#) [USBFTVSCCG](#) [4689-1](#) [1-1734084-2](#) [MUSBC11135](#) [USBF21ZNSCC](#) [USBBFTV6ZC](#)  
[MUSBB151341](#) [10135326-001LF](#) [M9177/3-1](#) [TJ-105](#) [USB-A-S-F-B-VT](#) [4198](#) [690-024-633-031](#) [UB-20PMFP-LC7001](#) [USBFTVC6MRG](#)  
[UA-20BMFA-SL8001](#) [17-200011](#) [USBFTVC7ZC](#) [UB-20AFMM-LL7A01](#) [USBFTVC2MN](#) [CAP-WCCMLPB1](#) [1310-1031-01](#) [2041386-1](#)  
[2274475-3](#) [UB-20BMFA-SL8001](#) [UB-20PMFP-SC8003](#)