

REVISION RECORD			
REV	ECN	DESCRIPTION	DRFT DATE

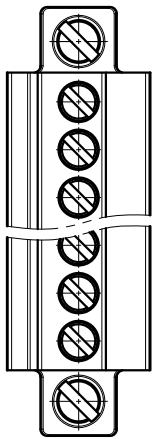

DRILL HOLE(2X)
 Ø0.80 MAX
 DEPTH 1.20MM

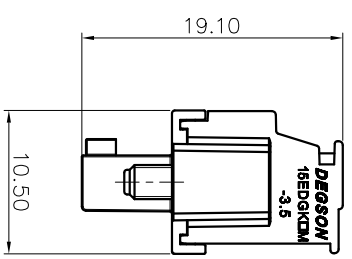
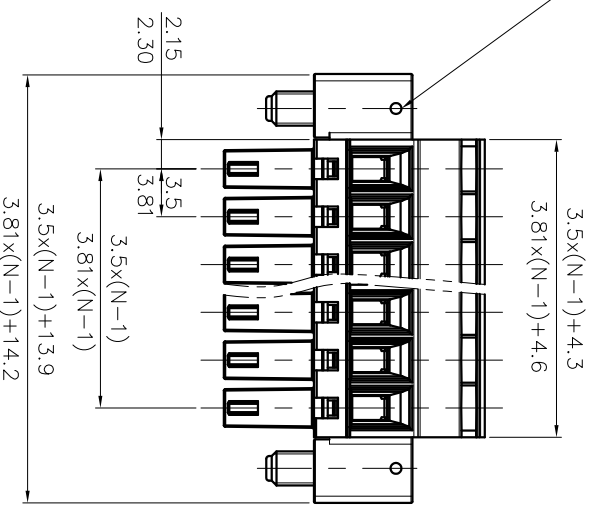
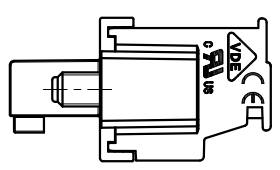

- NOTES1:
- UL Standard
 - Rated voltage/current : 300V / 8A
 - Withstanding voltage : AC1600V/1Min.
 - Torque value : M2 , 1.77Lb.in
 - Wire range : 28~16AWG
- IEC Standard
- | | |
|--------------------------|-------|
| Pollution degree | 2 |
| Overvoltage category | II |
| Rate impulse voltage(kV) | 2.5kV |
| Rate voltage(V) | 250V |
| Rate current(A) | 7A |
 - Torque value : M2 , 0.2N·m
 - Wire range : 0.5~1.5mm²

NOTES2:

- Dimension shall be interpreted per ASME Y14.5-2009
- Pitch : 3.5/3.81mm, Poles : N=02~24P
- Stripping length : 6~7mm
- Operating temperature : -40°C~+105°C
- Undimensioned tolerances:

Pitch	range		In	Nominal dimension		range	Tolerance		
	mm	Over		In	mm			Over	
6	TO	10	TO	30	60	100	0.1/10		
10	TO	24	TO	60	100	150	≤		
15	±0.15	±0.20	±0.30	±0.30	±0.50	±0.70	±1.00	±1.30	±2

6. RoHS Compliance

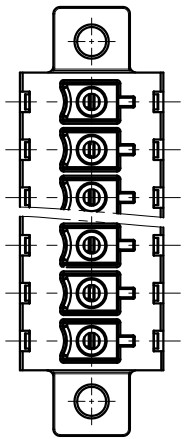
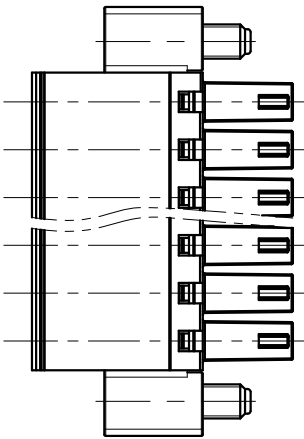
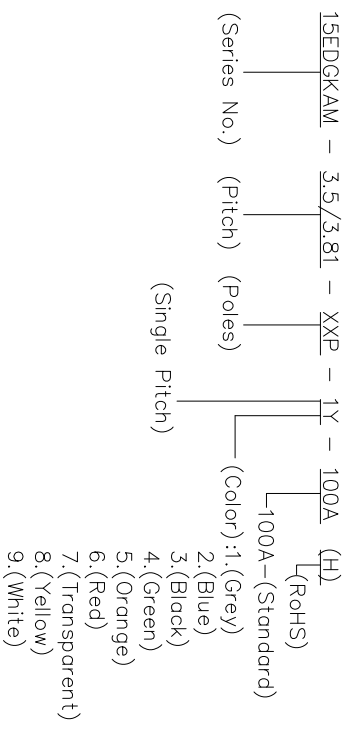

DETACHED LISTS			
PART NO.:	/	NAME:	DEGSON® NINGBO DEGSON ELECTRICAL CO., LTD 宁波高松电子有限公司
APPD:	/	CHKD:	/
DRFT:	/	TITLE:	CUSTOMER DRAWING
THIRD ANGLE PROJECTION		DRAWING NO.:	/
		DO NOT SCALE DRAWING	SCALE
			1:1

X-ON Electronics

Largest Supplier of Electrical and Electronic Components

Click to view similar products for [Pluggable Terminal Blocks](#) category:

Click to view products by [Degson](#) manufacturer:

Other Similar products are found below :

[57.404.7553](#) [57.504.0053.7](#) [57.510.0053](#) [57.910.6153](#) [01.112.1453](#) [CTB932VE/6](#) [MC 1.5/ 6-ST-3.5 GY AU](#) [ET02015000J0G](#) [734-104](#) [734-302](#) [734-304](#) [8-141-P](#) [FKCT 2.5/ 3-ST KMGY](#) [860505](#) [860508](#) [860516](#) [860810](#) [861908](#) [GBPACX-12](#) [93.731.4953.0](#) [PV05-5,08-K](#) [PVP02-5,00](#) [PVP04-3,50](#) [PVS02-5,00](#) [1-1986160-3](#) [H-10](#) [1546228-5](#) [ELFH09150](#) [ELFH16150](#) [ELFP03110](#) [ELFT06250](#) [ELFT07250](#) [ELVF09400](#) [ELVP03100](#) [ELXH03100](#) [ELXH071G0E](#) [ELXP041G0](#) [ELXT046G0](#) [1700101](#) [1700410](#) [1700425](#) [1703176](#) [1705229](#) [1710175](#) [1714537](#) [1717806](#) [1719600](#) [1729386](#) [1734692](#) [1734795](#)