

automotive, off-road and battery powered vehicles

product reference catalogue 2007/8



... advanced warning technology



Innovation and quality from Europe's Xenon and LED beacon and light bar specialist

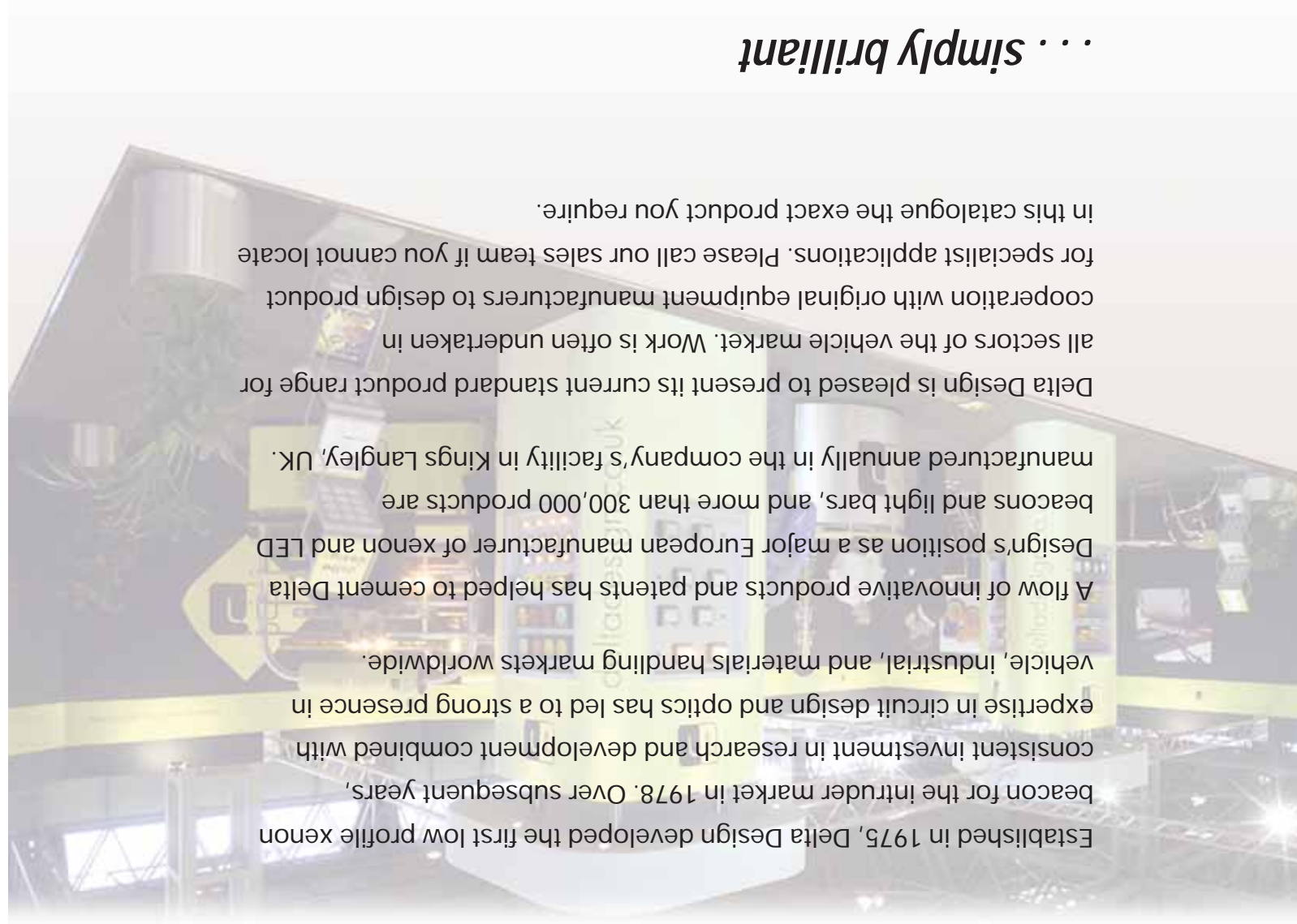

... simply brilliant

Established in 1975, Delta Design developed the first low profile xenon beacon for the intruder market in 1978. Over subsequent years, consistent investment in research and development combined with expertise in circuit design and optics has led to a strong presence in vehicle, industrial, and materials handling markets worldwide. A flow of innovative products and patents has helped to cement Delta Design's position as a major European manufacturer of xenon and LED beacons and light bars, and more than 300,000 products are manufactured annually in the company's facility in Kings Langley, UK. Delta Design is pleased to present its current standard product range for all sectors of the vehicle market. Work is often undertaken in cooperation with original equipment manufacturers to design product for specialist applications. Please call our sales team if you cannot locate in this catalogue the exact product you require.



a division of NICOTECH Limited

Primrose Hill, Kings Langley, Herts WD4 8ST, England.

Tel: (U.K.) 01923 272850 (Int.) +44 1923 272850
Fax: (U.K.) 01923 260167 (Int.) +44 1923 260167

E-mail: sales@deltadesign.co.uk
Web: www.deltadesign.co.uk



INVESTOR IN PEOPLE



United Registrar of Systems Cert No. 11211

Delta Design is a division of NICOTECH Ltd

Registration No. 1759896 England.

Registered Office: St. Paul's Hall, Kings Langley, Hertfordshire WD4 8RE.
V.A.T. Registration No. 403 9119 74.

Contents

Compact Vehicle Beacons	2
Alpha Star	2
Beta Star	3
Delta Star	4
Gamma Star	5
Durastrobe	5
Mid Size Vehicle Beacons	6
Zeta Star	6
Lunar Star	7
Large Vehicle Beacons	8
Solar Star	8
Turbo Star	9
Directional Vehicle Beacons	10
Microstrobe V0	10
LP Synchronus	11
VigilLED	12
SecuriLED	13
Rearguard LED	14
Rearguard Xenon	14
Materials Handling Beacons	15
Orion	15
Husky Pup	16
Pup2	17
Husky	18
Hedgehog LED	19
Hedgehog Xenon	19
Mini Light Bars	20
Pulsar ECE	20
Pulsar Economy	21

Xenergy Bars	22
Xenergy Range	22
Xenergy 610	23
Xenergy 860	24
Xenergy 1110	25
Xenergy 1360	26
Xenergy 1610	27
Xenergy Siren Bar 500mm	28
Xenergy Siren Bars 1000mm	29
Xenergy Siren Bars 1400mm	29
Xenergy Siren Bars 1500mm	29
Delta Bars	30
Delta Bar Range	30
EconoStrobe C	31
EconoStrobe R	32
Maxisafe	32
Xenon Flexibar	33
LED	34
LED + Illumination	35
Maxi-LED	36
Maxi-LED + Illumination	37
LED Flexibar	38
Hi-Wave Bars	39
Hi-Wave Delta and Hi-Wave Xenergy	39
Accessories	40
Spares	41
TYRI Work Lights	42
How to find us	44

Key to symbols used throughout this catalogue:

	Brightness: cd = effective candle in accordance with the Blondel & Rey formula		Single flash
	Flash rate		Double flash
	Ingress protection rating		Triple flash
	Weight		Current consumption at given voltage (n)
	Siren output		Current consumption
	Voltage range		Quad flash

All specifications are nominal and subject to change without notice.

Alpha Star RB4XDV/2



Certified to EMC directive 95/54.
 CE – complies with EMC Directive 89/336/EEC.
 High voltage transient and polarity reversal protection fitted.
 Operating temperature: -20° to +55°C.

Features:

A low cost 2W Xenon beacon with four mounting options.

- Dual voltage 12/24V (10 – 30Vdc)
- Bright, intense Xenon flash
- No moving parts – maintenance free
- Very low power consumption
- 3,000 hours tube life
- 12 months' guarantee

Applications:





Off-road use

Materials:

Polycarbonate lens, ABS base

10cd (amber)	75/min	single flash	145mA	110mA	0.27kg

Colour	Part No.	Part No.	Part No.	Part No.	Mounting Options
Green	420015	420045	420025	420005	Three Bolt Single Bolt Magnetic Pole Mount
Clear	420011	420041	420021	420001	
Red	420013	420043	420023	420003	
Blue	420014	420044	420024	420004	
Amber	420012	420042	420022	420002	

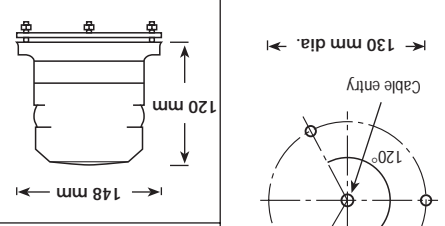

Drilling for Panel Mounting (ISO 4148)
 4 holes 7mm dia.
 120°
 Cable entry
 130 mm dia.
 120 mm
 148 mm

Beta Star RB4XDV/6



Certified to EMC directive 95/54.
 CE – complies with EMC Directive 89/336/EEC.
 High voltage transient and polarity reversal protection fitted.
 Operating temperature: -20° to +55°C.



	50cd (amber)
	75/min
	single flash
	600mA
	300mA
	IP65
	0.27kg

Features:

A low cost high brightness 6W general purpose Xenon beacon.

- Dual voltage 12/24V (10 – 32Vdc)

- Bright, intense Xenon flash

- No moving parts – maintenance free

- Very low power consumption

- 3,000 hours tube life

- 12 months' guarantee





Applications:

Wide range of vehicle applications including fleet, utilities, road maintenance, agriculture and construction plant.

Materials:

Polycarbonate lens, ABS base

Colour	Part No.	Mounting	Part No.	Part No.	Part No.	Part No.
Green	468015	Three Bolt	468012	468022	468082	468005
Clear	468011	-	-	-	-	468001
Red	468013	-	-	-	-	468003
Blue	468014	-	-	-	-	468004
Amber	468012	Magnetic	468022	468022	468082	468002
Amber	468015	Single Bolt	468015	468015	468015	468005



Delta Star RB2XDV/15



Certified to EMC directive 95/54.

CE - Complies with EMC Directive 89/336/EEC.

High voltage transient and polarity reversal protection fitted.

Operating temperature: -20°C to +50°C.



Features:

A very bright 15W Xenon beacon with a 125/min flash rate.

- Dual voltage 12/24V (10 – 30Vdc)

- Bright, intense Xenon flash

- No moving parts – maintenance free

- Low power consumption

- Compact design

- 3,000 hours tube life

- 12 months' guarantee

60cd (amber)	125/min	Single flash	1.5A	750mA	IP65
					0.27kg

Applications:

Cars, vans, light trucks and large vehicles.

Materials:

Polycarbonate lens, ABS base.

Colour	Part No.	Mounting	Image	Dimensions
Green	470005	Three Bolt		<p>Drilling for Panel Mounting (ISO 4148) 4 holes 7mm dia. 120° 120° Cable entry 130 mm dia. 148 mm 120 mm</p>
Clear	470001	Three Bolt		
Red	470003	Three Bolt		
Blue	470004	Three Bolt		
Amber	470002	Three Bolt		
	470017	Magnetic		
	470012	Single Bolt		
	470034	Pole Mount		

Gamma Star RC4XDV/6



Features:

- A 6W Xenon beacon with flexible single bolt base.
- Dual voltage 12/24V (10 – 32Vdc)
- Vibration protected circuit and impact resistant lens
- Flexible EVA single bolt mounting base
- Very low power consumption
- Long life
- Maintenance free
- 12 months' guarantee

Applications:

Applications include fleet, road maintenance, agriculture, construction plant, utilities, large vehicles and refuse trucks.

Amber	468092
Single Bolt	468092

Materials:
Polycarbonate lens, ABS base, EVA flexible mounting base.

Durastrobe RD4XDV/5A



Features:

- A 5W Xenon beacon with flexible pole mount base.
- Dual voltage 12/24V (10 – 32Vdc)
- Vibration protected circuit and impact resistant lens
- Flexible EVA pole mounting base to DIN 14 620
- Very low power consumption
- Long life
- Maintenance free
- 12 months' guarantee

Applications:

Applications include construction plant, contracting and agricultural vehicles.

See page 40 for accessories.

Amber	466002
Pole Mount	466002

Durastrobe	50cd (amber)	75/min	single flash	340mA	186mA	IP65	0.325kg
Gamma Star	60cd (amber)	75/min	single flash	356mA	280mA	IP55	0.325kg

Certified to EMC directive 95/54.
CE – complies with EMC Directive 89/336/EEC.
High voltage transient and polarity reversal protection fitted.
Operating temperature: -20° to +55°C.

Zeta Star ZB2SXDV/10



Certified to EMC directive 95/54.
 High voltage transient and polarity reversal protection fitted.
 Operating temperature: -30°C to +55°C (-30°C lower limit subject to intermittent and non-continuous use at temperatures below -20°C).

Features:

>60cd (amber)	120/min	single flash	1.2A	0.7A	IP65	0.37kg	

A low cost 10W Xenon beacon.

- Dual voltage 12/24V (10 – 30Vdc)
- Bright, intense Xenon flash
- No moving parts – maintenance free
- Low power consumption
- 3,000 hours tube life
- 12 months' guarantee

Applications:

Suitable for all vehicles including large vehicles, refuse trucks, recovery, fleets, highway maintenance and emergency services.

Materials:

Polycarbonate lens and base.

Lens Colour	Amber	Red	Blue	Green
Three Bolt	493052	493053	493054	493055
Magnetic	493072	-	-	-
Single Bolt	493062	-	-	-
Pole Mount	493082	-	-	-
Flexi Pole	493092	-	-	-

		Drilling for Panel Mounting (ISO 4148 / DIN 14620) 4 holes 7mm dia. 120° 120° Cable entry 130 mm dia.
--	--	--

						
>100cd (amber)	>42cd (blue)	120/min	double flash	1.5A	0.7A	IP65
0.37kg						

Features:

A high powered 15W Xenon beacon.

- Dual voltage 12/24V (10 – 30Vdc)
- Bright, intense Xenon flash
- No moving parts – maintenance free
- Low power consumption
- 3,000 hours tube life
- 12 months' guarantee
- Up to 4 beacons can be synchronised

Applications:

Suitable for all vehicles including large vehicles, refuse trucks, recovery, fleets, highway maintenance and emergency services.

Materials:

Polycarbonate lens and base.







Certified to EMC directive 95/54.

Certified to ECE R65.

High voltage transient and polarity reversal protection fitted.

Operating temperature: -30°C to +55°C (-30°C lower limit subject to intermittent and non-continuous use at temperatures below -20°C).

Lens Colour	Three Bolt	Magnetic	Single Bolt	Pole Mount	Flexi Pole
Amber	493002	493022	493012	493032	493042
Blue	493004	493024	493014	493034	493044

Drilling for Panel Mounting (ISO 4148 / DIN 14620)

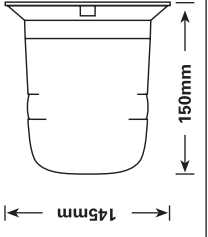
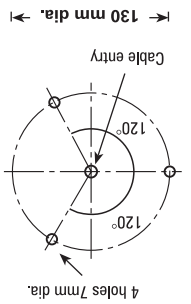
Solar Star SCU2DXDV/15



Certified to EMC directive 95/54.
CE – complies with EMC Directive 89/336/EEC.

Certified to ECE R65.

High voltage transient and polarity reversal protection fitted.

Operating temperature: -30°C to +55°C (-30°C lower limit subject to intermittent and non-continuous use at temperatures below -20°C).

Features:

A high powered Xenon beacon with high performance optics.

>100cd (amber) >42cd (blue)	120/min	double flash	1.25A	600mA	IP65	0.45kg			

- Automatically adjusts to both 12V and 24V (11.5 – 30Vdc)
- Homologated to ECE R65
- Up to 4 beacons can be synchronised
- 3,000 hours tube life
- 12 months' guarantee

Applications:

Suitable for all vehicles including large vehicles, refuse trucks, recovery, fleets, highway maintenance and emergency services.

Materials:

Polycarbonate lens, ABS base.

Colour	Part Number	Mounting Type	Material	Dimensions	Notes
Blue	470091	Three Bolt	Polycarbonate lens, ABS base	160 mm (width), 170 mm (height)	Drilling for Panel Mounting (ISO 4148 / DIN 14620) 4 holes 7mm dia. Cable entry 120° 120° 130 mm dia.
Amber	470090	Three Bolt	Polycarbonate lens, ABS base	160 mm (width), 170 mm (height)	
Amber	470092	Magnetic	Polycarbonate lens, ABS base	160 mm (width), 170 mm (height)	
Amber	470094	Pole Mount	Polycarbonate lens, ABS base	160 mm (width), 170 mm (height)	
Amber	470095	Pole Mount	Polycarbonate lens, ABS base	160 mm (width), 170 mm (height)	
Clear Lens	470075	Three Bolt	Polycarbonate lens, ABS base	160 mm (width), 170 mm (height)	Non ECE R65 Approved Version



Certified to EMC directive 95/54.
CE – complies with EMC Directive 89/336/EEC.

Certified to ECE R65.

High voltage transient and polarity reversal protection fitted.

Operating temperature: -30°C to +55°C (-30°C lower limit subject to intermittent and non-continuous use at temperatures below -20°C).

				
>100cd (amber)	! 24V	double flash	IP65	0.45kg
>42cd (blue)	! 12V	120/min	600mA	
	1.25A			

Features:

A high powered Xenon beacon with an inner fresnel lens and a smooth easy-clean outer lens.

- Automatically adjusts to both 12V and 24V (11.5 – 30Vdc)
- Homologated to ECE R65

- Up to 4 beacons can be synchronised





- 3,000 hours tube life
- 12 months' guarantee

Applications:

Suitable for all vehicles including large vehicles, refuse trucks, recovery, fleets, highway maintenance and emergency services.

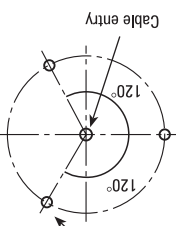
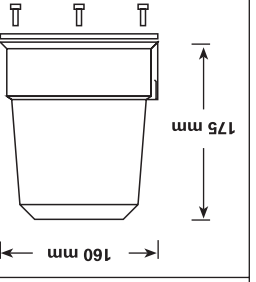
Materials:

Polycarbonate lens, ABS base.

Non ECE R65 Approved Versions			
ELB2DXDV/15	470053	470051	470055
Red Lens	Clear Lens	Green Lens	
<p>Drilling for Panel Mounting (ISO 4148 / DIN 14620)</p> <p>4 holes 7mm dia.</p>  <p>120°</p> <p>120°</p> <p>Cable entry</p>  <p>160 mm</p> <p>175 mm</p> <p>130 mm dia.</p>	 <p>470044</p>	 <p>470046</p>	 <p>470048</p>
Blue	470042	470045	470047
Amber			
Lens Colour	Three Bolt	Magnetic	Pole Mount

Microstrobe VQ XP4XMV/1-VQ



Certified to EMC directive 95/54.
 CE – complies with EMC Directive 89/336/EEC
 and Low Voltage Directive 73/23/EEC.
 High voltage transient and polarity reversal protection fitted.
 Operating temperature: -20°C to +50°C.

	12cd (amber)
	75/min
	single flash
	190mA
	105mA
	IP67 (lens)
	50gms

Features:

A compact and reliable high intensity Xenon warning light. Its small size makes it easy to install.

- Multivoltage 10V – 100Vdc
- Compact one piece housing
- Simple to install in 22mm drilled hole plus keyway
- IP67 lens assembly when installed
- 12 months' guarantee

Applications:

Suitable for use in a wide variety of vehicle applications including high level hazard warning for trucks and trailers, in-cab warning light for auxiliary equipment, temperature control indicator for refrigerated vehicles, vehicle reversing systems and as a vehicle security alarm indicator.

Materials:

Polycarbonate lens unit, ABS back box.

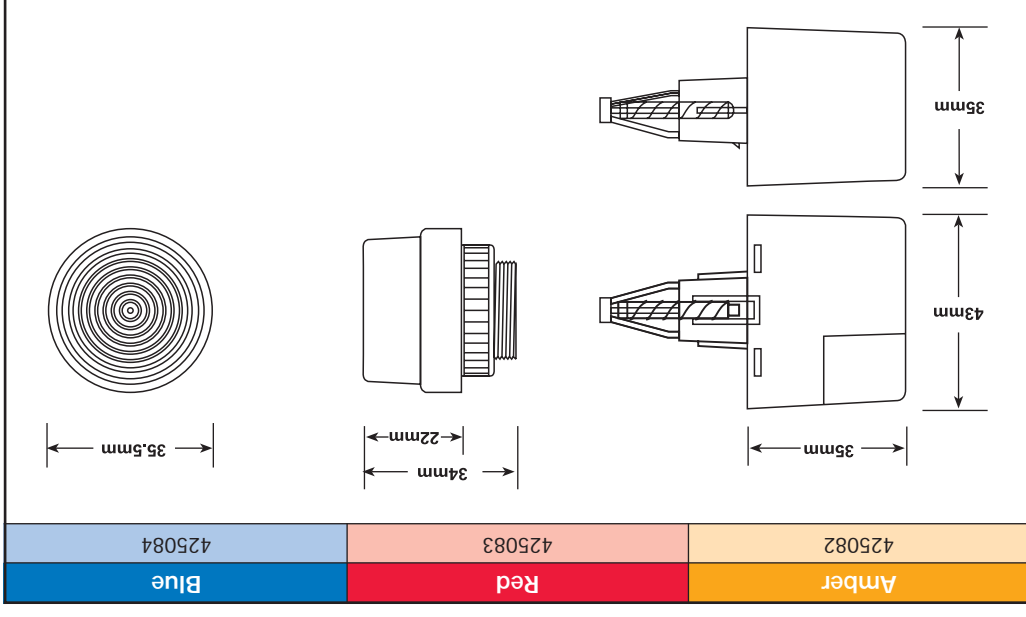

LP Synchronous Flash LP4XDV/2 SYNC (2watt) and LP4XDV/5 SYNC (5watt)



Certified to EMC directive 95/54.
High voltage transient and polarity reversal protection fitted.
Operating temperature: -20°C to +55°C.

Features:
A compact directional Xenon beacon with synchronous flash capability.

- Dual voltage 12/24V (10 – 30Vdc)
- Synchronous flash capability
- Vibration protected circuit
- 2W and 5W versions available
- 12 months' guarantee

Applications:

Suitable for many vehicle applications including fleet, cars, delivery, refuse trucks, large vehicles, road maintenance, recovery, utilities, road safety, plant and contracting.

Materials:

Polycarbonate lens, high impact polystyrene base.

	see table
	75min
	single flash
	2W: 192mA
	5W: 333mA
	2W: 96mA
	5W: 220mA
	IP67
	100gms

Part Number	Light Output	Power	Power	Light Output	Part Number
442001	50cd	2W	Clear	442001	442001
439001	85cd	5W		439001	439001
442002	25cd	2W	Amber	442002	442002
439002	45cd	5W		439002	439002
442003	11cd	2W	Red	442003	442003
439003	19cd	5W		439003	439003
442004	10cd	2W	Blue	442004	442004
439004	18cd	5W		439004	439004
442005	10cd	2W	Green	442005	442005
439005	18cd	5W		439005	439005

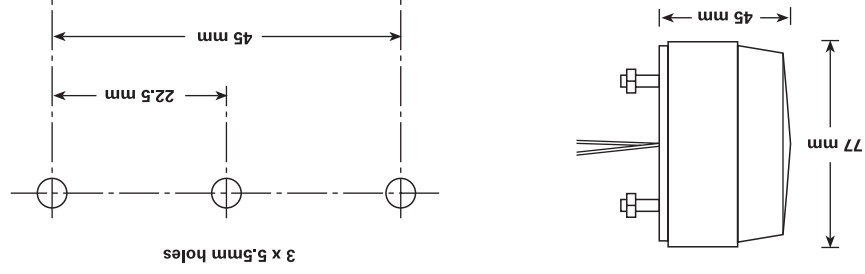



Certified to EMC directive 95/54.
CE – complies with EMC directive 89/336/EEC.

High voltage transient and polarity reversal protection fitted.
Operating temperature: -30°C to +55°C (-30°C lower limit subject to intermittent and non-continuous use at temperatures below -20°C).

	> 80cd (amber)	75/min		triple flash	120mA	65mA	IP67	170gms
--	----------------	--------	--	--------------	-------	------	------	--------

Features:

Surface mount or bracket mount triple flash LED directional.

- Dual voltage 12/24V (10 – 30Vdc)

- High brightness 100,000 hour rated LEDs

- Multiple beacons may be connected together to provide synchronous or alternate flash patterns

- Clear lens with coloured LEDs

- Ultra low power consumption

- Integral electronics – no need for separate power supply or control unit

- IP67 rated

- 3 year guarantee

Applications:

Suitable for many vehicle applications including fleet, cars, delivery, refuse trucks, large vehicles, road maintenance, recovery, utilities and road safety.

Materials:

Polycarbonate lens and base.

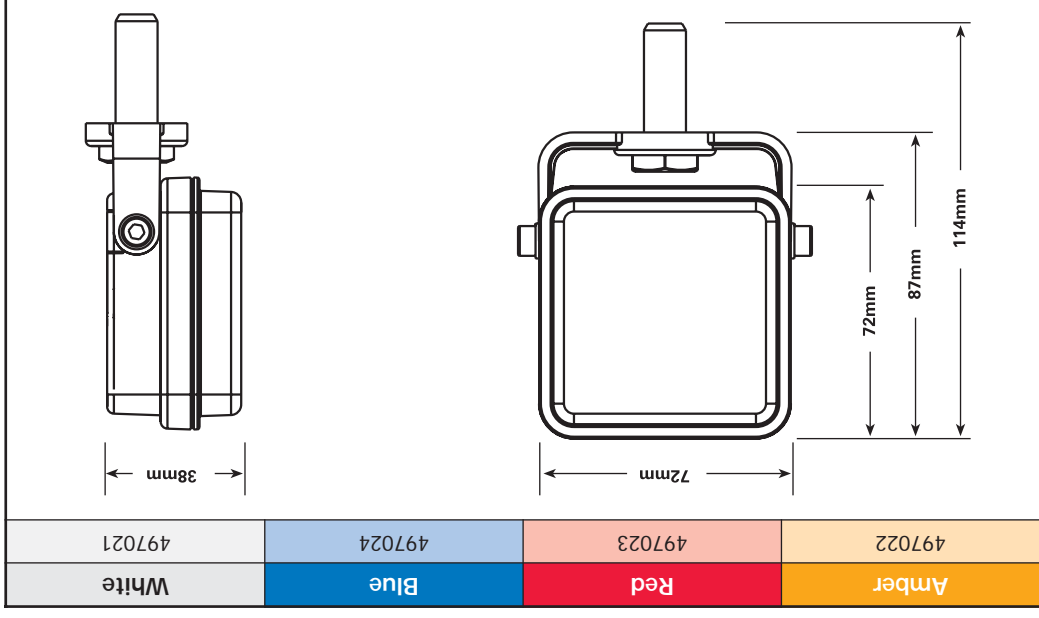

SecurLED SS20XDV/LED

Surface Mount



SecurLED SB20XDV/LED

Bracket Mount



Features:

- Surface mount or bracket mount quad flash LED directional.
- Intensely bright 3rd generation LEDs
- Dual voltage 12/24V (10 – 30Vdc)
- Multiple beacons may be connected together to provide synchronous or alternate flash patterns
- Bracket mount version adjusts horizontally and vertically
- Ultra low power consumption
- Integral electronics – no need for separate power pack or control unit
- IP67 rated
- 3 year guarantee

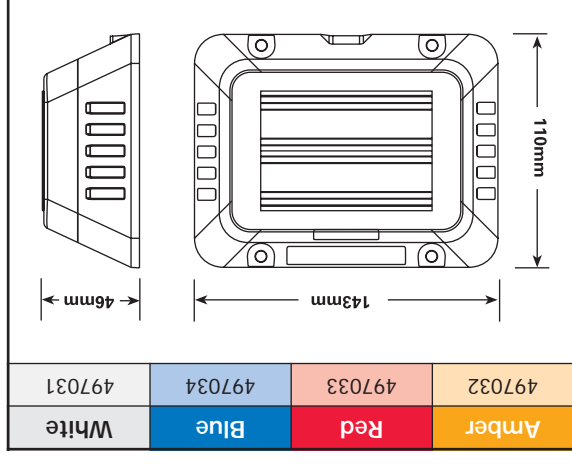

Applications:

Suitable for many vehicle applications including fleet, cars, delivery, refuse trucks, large vehicles, road maintenance, recovery, utilities and road safety.

Materials:

Polycarbonate lens, Aluminium base coated black.

Certified to EMC directive 95/54.
 CE – complies with EMC Directive 89/336/EEC.
 Certified to ECE R65 (amber and blue).
 Certified to PTO ACS 5.
 High voltage transient and polarity reversal protection fitted.
 Operating temperature: -30°C to +55°C (-30°C lower limit subject to intermittent and non-continuous use at temperatures below -20°C).



	>200cd (amber)		120/min	quad flash	400mA (1.5A Peak)	200mA (750mA Peak)	IP67	370gms
--	----------------	--	---------	------------	-------------------	--------------------	------	--------

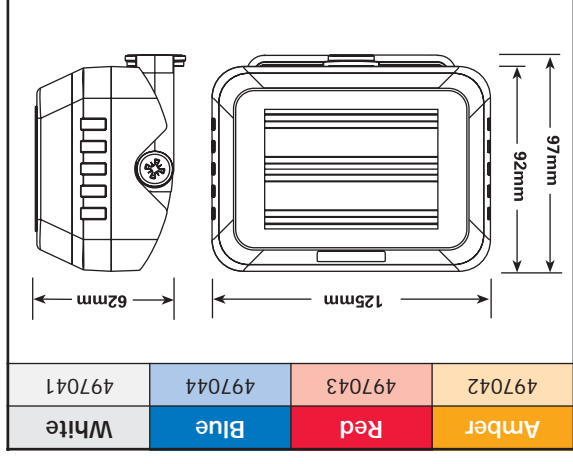

Rearguard LED

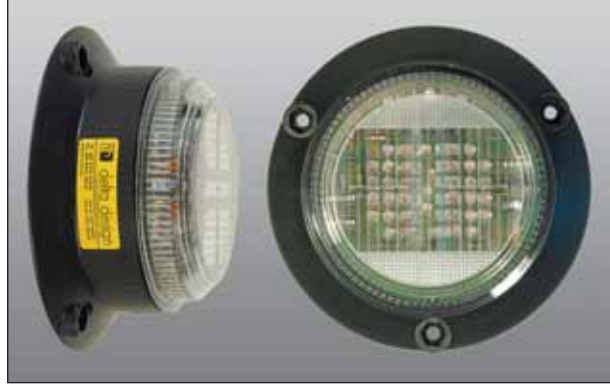

Certified to EMC directive 95/54.
CE – complies with EMC Directive 89/336/EEC.
High voltage transient and polarity reversal protection fitted.
Operating temperature: -20°C to +55°C.

Amber	497001
-------	--------

Rearguard Xenon SQ4XDV/5 RG



Certified to EMC directive 95/54.
CE – complies with EMC Directive 89/336/EEC.
High voltage transient and polarity reversal protection fitted.
Operating temperature: -20°C to +55°C.

Amber	426002	Blue	426004	Red	426003	Clear	426001	Green	426005
-------	--------	------	--------	-----	--------	-------	--------	-------	--------

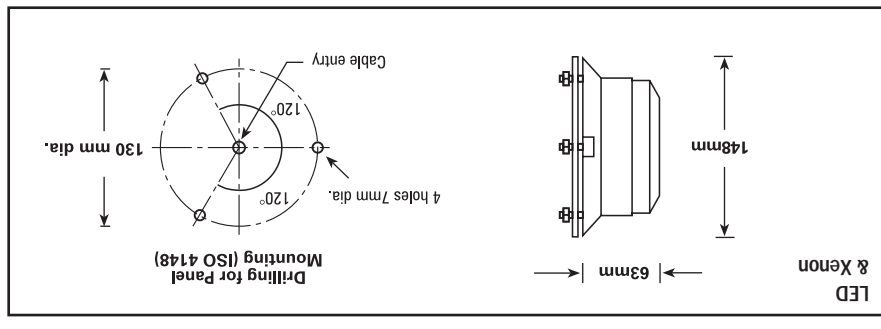

Materials: Polycarbonate lens, ABS base.

Applications: Suitable for many vehicle applications including utility, refuse trucks, street cleaners, drain cleaners, agricultural, delivery, recovery and emergency services.

- Features:**
- Dual voltage 12/24V (10 – 30Vdc)
 - High intensity hazard warning light
 - Directional – all light transmitted in chosen direction
 - Up to 8 beacons may be connected to flash synchronously or alternately
 - 12 months' guarantee

> 70cd (amber)	75mins	single flash	380mA	180mA	IP65	242gms
----------------	--------	--------------	-------	-------	------	--------

Materials: Polycarbonate lens, ABS base.

Applications: Suitable for many vehicle applications including utility, refuse trucks, street cleaners, delivery, recovery and large vehicles.

- Features:**
- Dual voltage 12/24V (10 – 30Vdc)
 - High intensity directional hazard warning
 - Up to 8 beacons may be connected to flash synchronously or alternately
 - Clear lens with amber LEDs
 - 12 months' guarantee

< 80cd	75mins	triple flash	145mA	120mA	IP65	240gms
--------	--------	--------------	-------	-------	------	--------

Orion 3XMV/LED

Patent Pending / Registered Community Design / US Design Patent



CE – certified to EMC directive 2004/108/EC.
 Complies with low voltage directive 73/23/EEC.
 High voltage transient and polarity reversal protected.
 Operating temperature: -20°C to + 50°C.
 Beacon should be operated in a vertical position with lens uppermost.



15cd	65 flashes/min	10-100Vdc	350mA	60mA	IP65	0.31kg

Features:

A bright, multivoltage, amber LED beacon with low power consumption.

- Multivoltage 10 – 100 Vdc
- Clear lens with amber coloured LEDs
- Bright, intense '6 burst' LED flash
- Low power consumption
- 3 year guarantee
- Weatherproof to IP65

Product options:

- European 130mm PCD hole pattern to ISO 4148
- US 118mm (4 3/8") PCD hole pattern
- Sounder plinth, fixes to base of beacon



FX29 Sounder Plinth
 Part No. 521047

Applications:

Suitable for fork lift trucks and battery powered vehicles.

Materials:

Polycarbonate lens, EVA/PVC base.
 Product is ROHS compliant.

Amber		<p>498001</p> <p>Europe</p> <p>Drilling for Panel Mounting (ISO 4148)</p> <p>4 holes 7mm dia.</p> <p>Cable entry</p> <p>120°</p> <p>130 mm dia.</p>	<p>498010</p> <p>USA</p> <p>Drilling for Panel Mounting (USA Hole Pattern)</p> <p>4 holes 6mm (0.236in) dia.</p> <p>120°</p> <p>120°</p> <p>Cable entry</p> <p>118 mm dia.</p>
-------	--	---	--

Husky Pup RB4XMV/2P



CE – certified to EMC directive 89/336/EEC.

Complies with low voltage directive 73/23/EEC.

High voltage transient and polarity reversal protected.

Operating temperature: -20°C to + 55°C.

Beacon should be operated in a vertical position with lens uppermost.

0.4kg	IP65	40mA	145mA	10-100Vdc 20-72Vdc	75 flashes/min	18cd (right amber)

Features:

A bright, multivoltage 2W Xenon beacon.

- Multivoltage 10 – 100 Vdc, 20 – 72 Vac
- Bright, intense Xenon flash
- Ultra-low power consumption
- 3,000+ hours tube life, 12 months' guarantee
- Weatherproof to IP65

Product options:

- European 130mm PCD hole pattern to ISO 4148
- US 118mm (4 3/8") PCD hole pattern
- Sounder plinth, fixes to base of beacon



FX29 Sounder Plinth
Part No. 521047

Applications:

Suitable for fork lift trucks and battery powered vehicles.

Materials:

Polycarbonate lens, ABS base.

Lens Colour	Three Bolt Europe	Three Bolt USA	Magnetic	Pole Mount
Green	469043	-	-	-
Clear	469039	-	-	-
Blue	469042	-	-	-
Red	469041	469063	-	-
Amber	469040	469062	469086	469082

 Drilling for Panel Mounting (ISO 4148) 4 holes 7mm dia. Cable entry 130 mm dia.	 Drilling for Panel Mounting (USA Hole Pattern) 4 holes 6mm (0.236ins) dia. Cable entry 118 mm dia.	 120 mm 148 mm
--	---	----------------------



CE – certified to EMC directive 89/336/EEC.

Complies with low voltage directive 73/23/EEC.

UL listed – file AU 3700.

High voltage transient and polarity reversal protected.

Operating temperature: -20°C to + 55°C.

Beacon should be operated in a vertical position with lens uppermost.

	0.244kg		IP65		40mA		145mA		10-100Vdc 20-72Vac		75 flashes/min		>18cd
--	---------	--	------	--	------	--	-------	--	-----------------------	--	----------------	--	-------

Features:

A bright, multivoltage 2W Xenon beacon.

- Multivoltage 10 – 100 Vdc, 20 – 72 Vac
- Bright, intense Xenon flash
- Ultra-low power consumption
- 3,000+ hours tube life, 12 months' guarantee
- Weatherproof to IP65

Product options:

- Sounder plinth, fixes to base of beacon



FX29 Sounder Plinth
Part No. 521047

Applications:

Suitable for fork lift trucks and battery powered vehicles.

Materials:

Polycarbonate lens, EVA/PVC base.

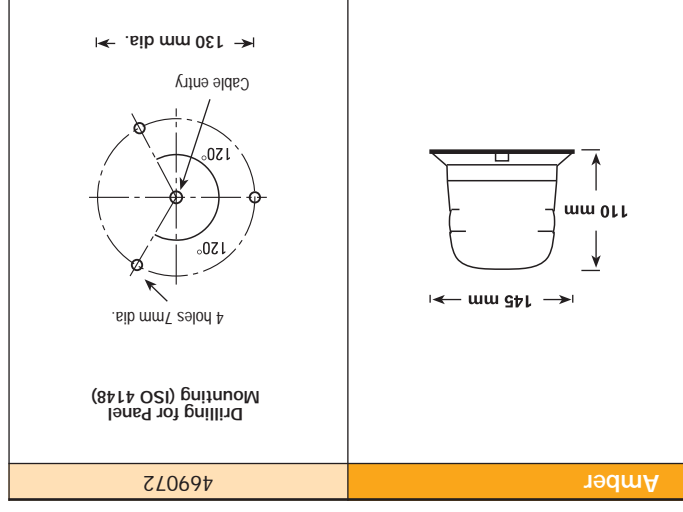



CE – certified to EMC directive 89/336/EEC.

Complies with low voltage directive 73/23/EEC.

High voltage transient and polarity reversal protected.

Operating temperature: -20°C to + 55°C.

Beacon should be operated in a vertical position with lens uppermost.

0.4kg	IP65	60mA	360mA	10-100Vdc 30-60Vac	75 flashes/min	4cd (amber)

Features:

A bright, multivoltage 5W Xenon beacon.

- Multivoltage 10 – 100 Vdc, 30 – 60 Vac
- Bright, intense Xenon flash
- Low power consumption
- 3,000+ hours tube life, 12 months' guarantee
- Replaceable Xenon tube
- Weatherproof to IP65

Product options:

- Sounder plinth, fixes to base of beacon



FX29 Sounder Plinth
Part No. 521047

Applications:

Suitable for fork lift trucks and battery powered vehicles.

Materials:

Polycarbonate lens, ABS base.

469012	Amber
469013	Red
469004	Blue
469011	Clear
469005	Green

Drilling for Panel
Mounting (ISO 4148)

4 holes 7mm dia.
120°
120°
Cable entry
130 mm dia.

148 mm
120 mm

Hedgehog LED S01XMV/LED 360/24 and S01X12/LED 360/24

S01XMV/LED 360/24	60 flashes/min	20-100Vdc	24mA	IP65
S01X12/LED 360/24	60 flashes/min	10-15Vdc	48mA	IP65

Features:

A bright low profile LED beacon.

- High intensity flash
- Ultra-low power consumption
- 3 year guarantee
- Weatherproof to IP65
- Can be installed lens upwards or inverted

Product options:

- Multivoltage 20 – 100 Vdc or 10 – 15 Vdc version
- Sounder plinth , fixes to base of beacon (see Husky product options)



Lens Colour	Amber
20 – 100 Vdc	424001
10 – 15 Vdc	424011

Hedgehog Xenon S04XMV/2 360



Amber	424095
Red	424096

Features:

A bright, multivoltage low profile 2W Xenon beacon.

- Multivoltage 10 – 100 Vdc, 20 – 72 Vac
- Bright, intense Xenon flash
- Ultra-low power consumption
- 12 months' guarantee
- Weatherproof to IP65
- Can be installed lens upwards or inverted

Product options:

- Sounder plinth , fixes to base of beacon (see Husky product options)



CE – certified to EMC directive 89/336/EEC.

Complies with low voltage directive 73/23/EEC.

Operating temperature: –20°C to + 55°C (max 40°C above 80V).

Applications:

Suitable for fork lift trucks, industrial sweepers and battery powered vehicles.

Materials: Polycarbonate lens, ABS base.

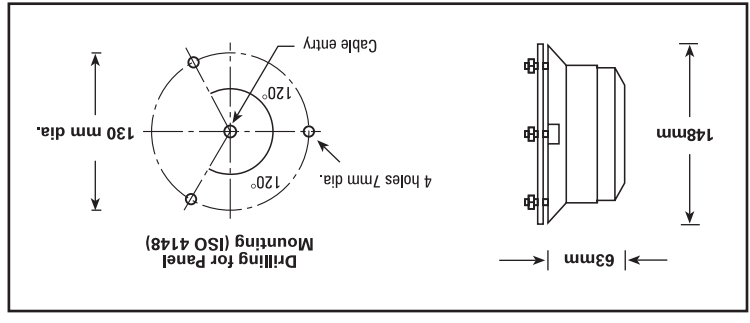

Information common to both Hedgehog LED and Hedgehog Xenon beacons

Pulsar ECE



Certified to EMC directive 95/54.

Certified to ECE R65.

High voltage transient and polarity reversal protection fitted.
Operating temperature: -20° to +55°C.



> 100cd (amber)	120/min	double flash	3A	1.6A	IP54	1.41kg (fixed) 2.15kg (mag)

Features:

ECE R65 certified mini light bar with 2 synchronised strobes.

- Dual voltage 12/24V (10.5 – 30Vdc)
- Magnetic mount version available
- 3,000 hours tube life
- 12 months' guarantee

Applications:

Suitable for many vehicle applications including fleet, road maintenance, cars, large vehicles, refuse trucks, road safety and emergency services.

Materials:

Polycarbonate base and cover.

		Lens Colour
	Fixed	Amber
	483002	483004
Magnetic	483012	483014

Pulsar Economy



Certified to EMC directive 95/54.
 High voltage transient and polarity reversal protection fitted.
 Operating temperature: -20° to + 55°C.

	>50cd (amber)	75min	single flash alternate	1.1A	760mA	IP54	1.1kg (fixed)	1.9kg (mag)
--	---------------	-------	------------------------	------	-------	------	---------------	-------------

Features:

Low cost mini light bar with 2 alternating strobes.

- Dual voltage 12/24V (10.5 – 30Vdc)
- Magnetic mount version available
- 3,000 hours tube life
- 12 months' guarantee

Applications:

Suitable for many vehicle applications including fleet, road maintenance, cars, large vehicles, refuse trucks, road safety and emergency services.

Materials:

Polycarbonate base and cover.

Lens Colour	Fixed	Magnetic
Amber	483022	483032
Blue	483024	483034

Xenergy Range

Features:

An extensive range of high quality competitively priced light bars for amber and blue markets.

- Dual voltage 12/24V
- Double flash end strobes
- Five lengths available: 610, 860, 1110, 1360 and 1610mm
- Clear cover versions available in each length
- Long life Xenon flash tubes
- Low power consumption
- 12 months' guarantee

Options:

- Centre Illumination / Lettering service
- LED directional strobes
- LED stop/tail/indicator light clusters
- Work lights
- Alley lights

- Easily installed and removed magnetic mount option for a range of 610 and 860mm bars. Tested by TÜV, the German automotive test house, to 200km/hr.

Applications:

Suitable for all sectors of the commercial vehicle market and emergency services.

Materials:

Polycarbonate lens covers, aluminium base extrusion.

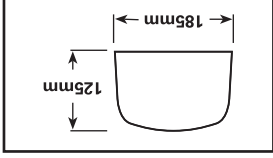

Applications: Suitable for all sectors of the commercial vehicle market and emergency services. Materials: Polycarbonate lens covers, aluminium base extrusion.

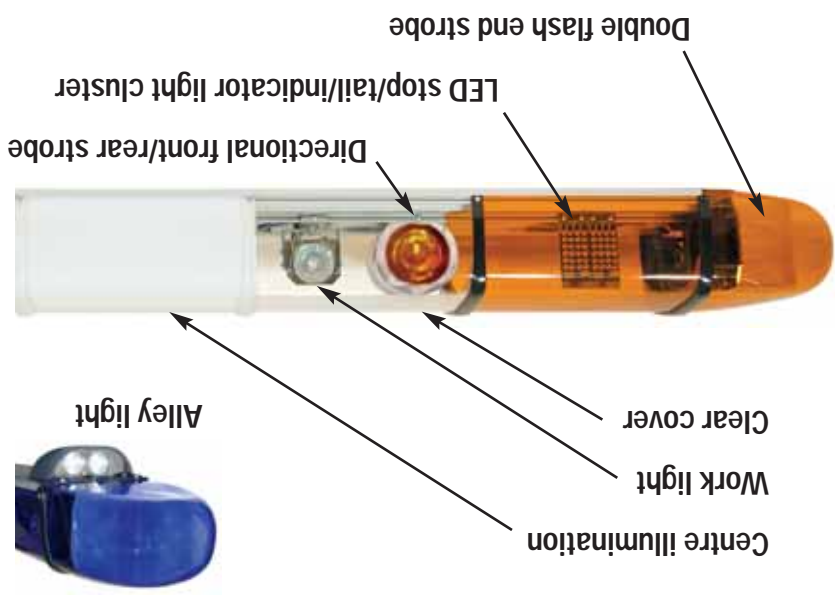

	End strobes	< 100cd (amber) > 42cd (blue)	120/min double flash	IP65
	Directional front/rear strobes	> 400cd	65/min (nominal) random	IP65

Certified to EMC directive 95/54.

Certified to ECE R65.

High voltage transient and polarity reversal protection fitted.

Operating temperature: -30°C to +55°C (-30°C lower limit subject to intermittent and non-continuous use at temperatures below -20°C).

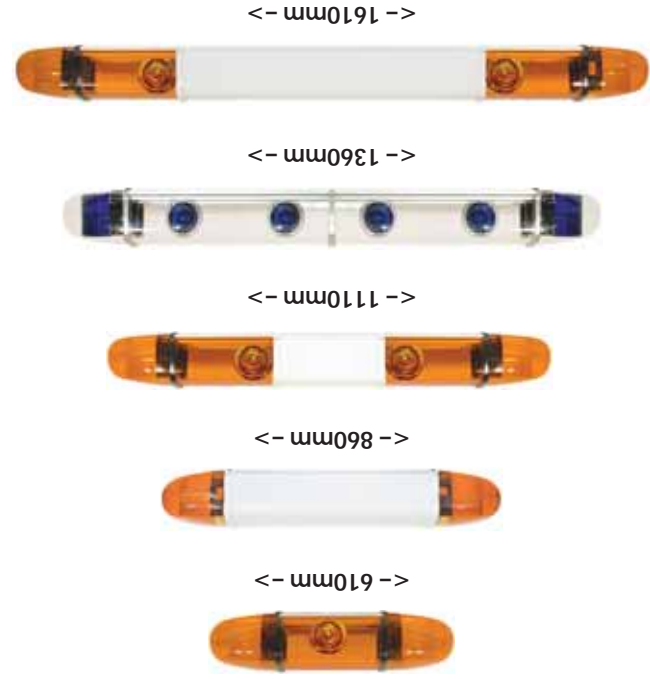

Key to Model Numbers:

2 X A 1. 1360
↓
Length (mm)
↓
Centre Illumination Panel
1 = 250mm illumination panel
21 = 500mm illumination panel
31 = 750mm illumination panel
Main Lens Colour
A = Amber, B = Blue,
C = Precedes lens colour if clear cover.
Strobes
Xenergy

2 = 2 end strobes
For numbers above 2 add directional strobes, e.g. 4 means two end strobes and two directional strobes.

Other letters denote:

R = Bar designed for recovery market

L = LED stop/tail/indicator light cluster

W = Work light

MAG = Magnetic mount kit

V/LED F&R = LED directional front and rear













Xenergy 610



Product	12V	24V	Dual 12/24V	?	12V	?	24V
2XA.610	-	-	49001	3A	1.42A		
2XB.610	-	-	49002	3A	1.42A		
2XA1.610	49003	49007	-	3.83A	1.83A		
2XB1.610	49104	49008	-	3.83A	1.83A		
2XCA.610	-	-	49005	3A	1.42A		
2XCB.610	-	-	49006	3A	1.42A		
3XA.610	-	-	49009	3.4A	1.7A		
3XB.610	-	-	48999	3.4A	1.7A		
2XA.610 2 V/LED F&R	-	-	491050	3.5A	1.7A		
2XA.610 MAG	-	-	49101	3A	1.42A		
2XB.610 MAG	-	-	49102	3A	1.42A		
2XA1.610 MAG	49103	49107	-	3.83A	1.83A		
2XB1.610 MAG	49104	49108	-	3.83A	1.83A		
2XCB.610 MAG	-	-	49106	3A	1.42A		
2XA.610 2 V/LED F&R MAG	-	-	491051	3.5A	1.7A		

Xenergy 860



Product	12V	24V	Dual 12/24V			
2XA.860	-	-	490011	3A	1.42A	
2XB.860	-	-	490012	3A	1.42A	
2XA21.860	490013	490017	-	4.67A	2.25A	
2XB21.860	490014	490018	-	3A	1.42A	
2XCA.860	-	-	490015	3A	1.42A	
2XCB.860	-	-	490016	4A	2A	
2XA.860 2 V/LED F&R	-	-	491055	3.5A	1.7A	
2XA.860 MAG	-	-	491011	3A	1.42A	
2XB.860 MAG	-	-	491012	3A	1.42A	
2XA21.860 MAG	491013	491017	-	3.83A	1.83A	
2XB21.860 MAG	491014	491018	-	3A	1.42A	
2XCB.860 MAG	-	-	491016	4A	2A	
4XA.860 MAG	-	-	491019	4A	2A	

Xenergy 1110



Product	12V	24V	Dual 12/24V	!	!	!
2XA.1110	-	-	490026	3A	1.42A	
2XB.1110	-	-	490036	3A	1.42A	
2XA1.1110	490020	490030	-	3.83A	1.83A	
2XB1.1110	490021	490031	-	4.15A	2.03A	
4XA.1110	-	-	490027	4.15A	2.03A	
4XB.1110	-	-	490029	4.98A	2.45A	
4XA1.1110	490022	490032	-	4.98A	2.45A	
4XB1.1110	490023	490033	-	4.15A	2.03A	
4XCA.1110	-	-	490024	4.15A	2.03A	
4XCB.1110	-	-	490025	5.2A	2.6A	
2XA31.1110	490028	490038	-	4.6A	2.3A	
2XB31.1110	490034	490037	-	4.6A	2.3A	
5XA.1110	-	-	490035	4.6A	2.3A	
5XB.1110	-	-	489903	4.6A	2.3A	
4XRL.1110	490081	490087	-	6A	3A	
4XRW.1110	490085	-	-	11A	-	
2XA.1110 4 V/LED F&R	-	-	491060	4A	2A	











Xenergy 1360



Product	12V	24V	Dual 12/24V	?	?	?
2XA.1360	-	-	490047	3A	1.42A	
2XB.1360	-	-	490057	3A	1.42A	
2XA21.1360	490041	490051	-	4.67A	2.25A	
2XB21.1360	490042	490052	-	4.67A	2.25A	
4XA.1360	-	-	490043	4.15A	2.03A	
4XB.1360	-	-	490044	4.15A	2.03A	
6XA.1360	-	-	489904	5.2A	2.6A	
4XCA.1360	-	-	490045	4.15A	2.03A	
4XCB.1360	-	-	490046	4.15A	2.03A	
2XA41.1360	490050	490053	-	6A	3A	
2XB41.1360	-	-	490055	6A	3A	
4XA21.1360	490049	490054	-	5.6A	2.8A	
4XB21.1360	490048	-	-	5.6A	2.8A	
6XCB.1360	-	-	490093	5.2A	2.6A	
4XRL.1360	490082	490088	-	6A	4A	
4XRVL.1360	-	490086	-	-	7A	

Xenergy 1610



Product	12V	24V	Dual 12/24V	?	?	?
2XA31.1610	490061	490071	-	5.5A	2.67A	
2XB31.1610	490062	490072	-	-	-	
4XA1.1610	490063	490073	-	4.89A	2.45A	
4XA.1610	-	489905	4A	2A	-	
4XCA.1610	-	490065	4.15A	2.03A	-	
4XC31.1610	-	490075	-	-	3.2A	
8XA1.1610	-	-	490067	5.4A	3.1A	
4XL4V.1610	-	490078	-	-	8.5A	
4XRLV.1610	490083	490089	-	12A	6A	
4XRL.1610	-	490090	-	-	4A	
4XR31.1610	-	490091	-	-	4A	

500mm Xenergy Siren Bar



40W 100dB	IP65	4.5A (max)	double flash	120min	> 100cd (amber) > 42cd (blue)

Features:

Dual-tone siren bar.

- Magnetic and permanent mount versions
- Magnetic version certified by TÜV for speeds up to 200kph
- 12 volt
- 40W (100dB) siren with 'Wail' and 'Yelp' tones
- Magnetic version has DIN plug with integral 3 position selector switch for siren
- Xenon strobes certified to ECE R65 (blue and amber versions)
- 12 months' guarantee

Applications:

Emergency, fire and medical services.

Materials:

Polycarbonate lens covers, aluminium base extrusion.

Suitable for emergency, fire, medical and security services.
Tested by TÜV Germany to 200kph



Certified to EMC directive 2004/104/EC.

Certified to ECE R65.

High voltage transient and polarity reversal protection fitted.

Operating temperature: -30°C to +55°C (-30°C lower limit subject to intermittent and non-continuous use at temperatures below -20°C).

492006	492005	492008	492002	Permanent Mount
492003	492004	492007	492001	Magnetic Mount
Amber	Blue/Green	Green	Blue	Type

40W/80W Xenergy Siren Bars

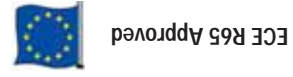

End strobes	> 42cd (blue)	120/min	double flash	IP65	40W: 100dB 80W: 105dB
Directional front/rear strobes	> 400cd	65/min (nominal)	random		

Features:

- 40W and 80W versions
- 3 lengths available: 1000, 1400 and 1500mm
- 12 volt
- Siren with 'Wail' and 'Yelp' tones
- Xenon strobes certified to ECE R65
- 12 months' guarantee

Applications:

Emergency, fire and medical services.

Materials:

Polycarbonate lens covers, aluminium base extrusion.



Certified to EMC directive 2004/104/EC.

Certified to ECE R65.

High voltage transient and polarity reversal protection fitted.

Operating temperature: -30°C to +55°C (-30°C lower limit subject to intermittent and non-continuous use at temperatures below -20°C).

Suitable for emergency, fire, medical and security services.

Product	40W	80W	Length	?
4XB.1000	492040	-	1000mm	4.5A (max)
4XB.1400	492044	492048	1400mm	40W 6.7A (max) 80W 8.2A (max)
2XB3.1400	492045	492049	1400mm	40W 6.5A (max) 80W 8A (max)
4XB1B1.1400	492046	492050	1400mm	40W 6.7A (max) 80W 8.2A (max)
4XB1B1.1400	492047	492051	1400mm	40W 6.5A (max) 80W 8A (max)
2XB.1500	492042	-	1500mm	4.5A (max)
4XB.1500	492043	-	1500mm	5.5A (max)

Delta Bar Range

Features and Options:

A range of high quality low profile light bars for amber and blue markets. Xenon, xenon/LED and Full LED variants are available.

- Dual voltage 12/24V

- Single flash Xenon corner strobes

- Intensely bright 3rd generation LED corners

- Xenon face strobes feature a choice of high visibility ripple flash pattern

- LED face modules feature a unique high visibility tri-phase flash pattern

- Seven lengths available: 520, 750, 980, 1200, 1430, 1650 and 1885mm

- Aluminium box extrusion with front and rear face modules

- Long life Xenon flash tubes and LED modules

- Low power consumption

- Flexibars: individually configured to your specifications

- Easily installed and removed magnetic mount version for a range of 520 and 750mm bars. Please call for further information

- 12 months' guarantee

Mounting Options:

- Standard mount consists of four rubber feet. Side mounting kit available for specific applications.

Applications:

Suitable for all sectors of the commercial vehicle market and emergency services.

Materials:

Polycarbonate lens covers, aluminium box extrusion.



	Xenon corner strobes	> 100cd (amber)	> 42cd (blue)	120/min	single flash	IP65
---	-----------------------------	-----------------	---------------	---------	--------------	------

Certified to EMC directive 95/54.

Certified to ECE R65.

High voltage transient and polarity reversal protection fitted.

Operating temperature: -20° to + 55°C.

	LED corner strobes	> 100cd (amber)	> 50cd (blue)	120/min	quad flash	IP65
---	---------------------------	-----------------	---------------	---------	------------	------

Certified to EMC directive 2004/104/EC.

Certified to ECE R65 (blue only).

High voltage transient and polarity reversal protection fitted.

Operating temperature: -20° to + 55°C.

DB1 520 (20")		
---------------	--	--

DB2 750 (30")			
---------------	--	--	--

DB3 980 (39")				
---------------	--	--	--	--

DB4 1200 (47")					
----------------	--	--	--	--	--

DB5 1430 (56")						
----------------	--	--	--	--	--	--

DB6 1650 (65")							
----------------	--	--	--	--	--	--	--

DB7 1885 (74")								
----------------	--	--	--	--	--	--	--	--

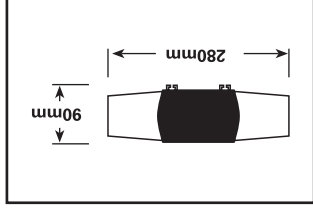



Product	Length (mm)	12V	24V	12V ?	24V ?	Each bar shown front & rear (front at the top)
Econostrobe C 1DB	520	880051	-	3.63A	-	
Econostrobe C 2DB	750	880052	-	4.46A	-	
Econostrobe C 3DB	980	880053	880057	5.03A	2.52A	
Econostrobe C 4DB	1200	880054	880068	5.86A	2.94A	
Econostrobe C 5DB	1430	880055	880069	8.09A	4.06A	
Econostrobe C 6DB	1650	880056	880060	7.26A	3.64A	

Econostrobe R

Standard Light Bar for the recovery market. Incorporates extra Xenon strobes to rear face of light bar.



Econostrobe R 4DB front and rear

Product	Length (mm)	12V	24V	12V ? 12V ? 24V	Each bar shown front & rear (front at the top)
Econostrobe R 4DB	1200	880064	880067	5.86A	3.04A
Econostrobe R 5DB	1430	880065	880070	8.89A	4.09A
Econostrobe R 6DB	1650	880066	880071	8.68A	4.44A

Maxisafe

Standard light bar for the recovery, rescue and road maintenance markets. Incorporating full Xenon strobes and highly visible ripple flash pattern to the rear face of the light bar.



Maxisafe 4DB front and rear

Product	Length (mm)	12V	24V	12V ? 12V ? 24V	Each bar shown front & rear (front at the top)
Maxisafe 4DB	1200	880074	880073	12.86A	6.44A
Maxisafe 5DB	1430	880075	880072	15.09A	7.56A
Maxisafe 6DB	1650	880076	880077	15.6A	7.84A

Xenon Flexibar

Choose from a wide range of options individually configured to your own specification.



12W Xenon Modules	6W Xenon Modules	Split face Xenon & Worklight Modules

Illuminated Modules	Alley Lights

20W & 35W Worklights	Lettering Service

DB1 520 (20")

DB2 750 (30")

DB3 980 (39")

DB4 1200 (47")

DB5 1430 (56")

DB6 1650 (65")

DB7 1885 (74")

Standard Base Configuration:

4 x 6W flashing corners with dummy modules to front and rear.

LED stop/tail/indicator modules.
Flashing Halogens.

Other options include:

Example Configuration DB5 1430 (56"):

Front: 2 x 6W Xenon Modules (synchronised with corner modules), 2 x Split Modules with dichroic work lamps, 1 x Illuminated Module.



Rear: 2 x 6W Xenon Modules (synchronised with corner modules), 3 x 12W Xenon Modules with coded ripple pattern.

Please advise 12V or 24V when ordering.

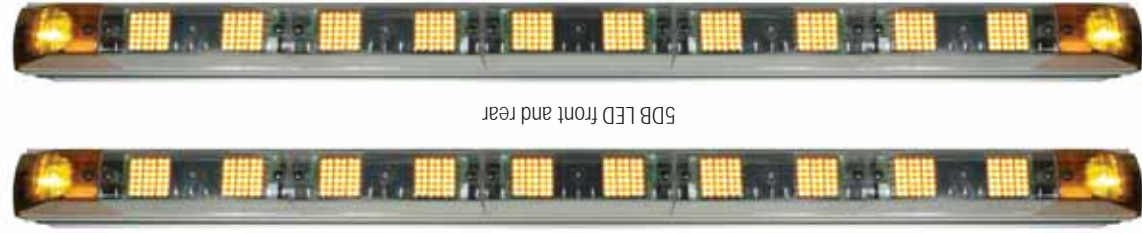

5DB LED front and rear

Product	Length (mm)	Dual Voltage	12V	24V	Each bar shown front & rear (front at the top)
LED/LED 1DB	520	880410	4A	2A	
LED/LED 2DB	750	880420	5.2A	2.8A	
LED/LED 3DB	980	880430	6.4A	3.2A	
LED/LED 4DB	1200	880440	7.6A	5.6A	
LED/LED 5DB	1430	880450	8.8A	4.4A	
LED/LED 6DB	1650	880460	10A	5A	
LED/LED 7DB	1885	880470	11.2A	5.6A	

Enhanced Delta Bar with Xenon strobe corners and LED face modules. Supplied with white illuminations to the front and tri-phase flash pattern to the rear.



LED/ILLU 5DB front and rear

Product	Length (mm)	12V	24V	12V	24V
LED/ILLU 1DB	520	880411	880415	4.23A	2.12A
LED/ILLU 2DB	750	880421	880425	5.66A	2.84A
LED/ILLU 3DB	980	880432	880636	6.63A	3.32A
LED/ILLU 4DB	1200	880646	880447	8.06A	4.03A
LED/ILLU 5DB	1430	880652	880456	9.49A	4.75A
LED/ILLU 6DB	1650	880663	880466	10.46A	5.23A
LED/ILLU 7DB	1885	880471	880475	11.89A	5.95A

Each bar shown front & rear (front at the top)

Maxi-LED
Featuring corners fitted with 3rd generation high brightness LEDs, quad flash pattern.



NEW LED corner module



5DB LED face and corners front and rear

Product	Length (mm)	Dual Voltage	12V	24V	?
LED/LED 1DB	520	880510	2.8A	1.4A	
LED/LED 2DB	750	880520	4A	2A	
LED/LED 3DB	980	880530	5.2A	2.6A	
LED/LED 4DB	1200	880540	6.4A	3.2A	
LED/LED 5DB	1430	880550	7.6A	3.8A	
LED/LED 6DB	1650	880560	8.8A	4.4A	
LED/LED 7DB	1885	880570	10A	5A	

Each bar shown front & rear (front at the top)

Maxi-LED + Illumination

Featuring corners fitted with 3rd generation high brightness LEDs, quad flash pattern. Supplied with white illumination to the front.

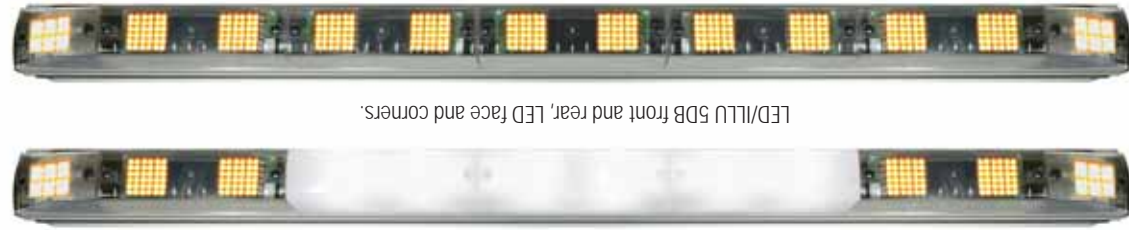

LED/ILLU 5DB front and rear, LED face and corners.

Product	Length (mm)	12V	24V	!	!	!	!
LED/ILLU 1DB	520	880511	880515	3.03A	1.52A		
LED/ILLU 2DB	750	880521	880525	4.46A	2.23A		
LED/ILLU 3DB	980	880532	880537	5.43A	2.72A		
LED/ILLU 4DB	1200	880542	880547	6.86A	3.43A		
LED/ILLU 5DB	1430	880552	880556	8.29A	4.15A		
LED/ILLU 6DB	1650	880563	880562	9.26A	4.63A		
LED/ILLU 7DB	1885	880571	880575	10.69A	5.35A		

Each bar shown front & rear (front at the top)

LED Flexibar

Choose from a wide range of options individually configured to your own specification.

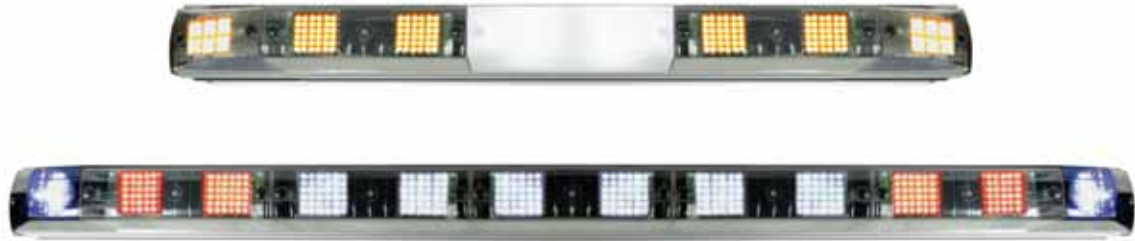

DB1 520 (20")	<input type="checkbox"/>	<input type="checkbox"/>	<input type="checkbox"/>
---------------	--------------------------	--------------------------	--------------------------

DB2 750 (30")	<input type="checkbox"/>	<input type="checkbox"/>	<input type="checkbox"/>
---------------	--------------------------	--------------------------	--------------------------

DB3 980 (39")	<input type="checkbox"/>	<input type="checkbox"/>	<input type="checkbox"/>	<input type="checkbox"/>
---------------	--------------------------	--------------------------	--------------------------	--------------------------

DB4 1200 (47")	<input type="checkbox"/>	<input type="checkbox"/>	<input type="checkbox"/>	<input type="checkbox"/>	<input type="checkbox"/>
----------------	--------------------------	--------------------------	--------------------------	--------------------------	--------------------------

DB5 1430 (56")	<input type="checkbox"/>	<input type="checkbox"/>	<input type="checkbox"/>	<input type="checkbox"/>	<input type="checkbox"/>	<input type="checkbox"/>
----------------	--------------------------	--------------------------	--------------------------	--------------------------	--------------------------	--------------------------

DB6 1650 (65")	<input type="checkbox"/>	<input type="checkbox"/>	<input type="checkbox"/>	<input type="checkbox"/>	<input type="checkbox"/>	<input type="checkbox"/>	<input type="checkbox"/>
----------------	--------------------------	--------------------------	--------------------------	--------------------------	--------------------------	--------------------------	--------------------------

DB7 1885 (74")	<input type="checkbox"/>	<input type="checkbox"/>	<input type="checkbox"/>	<input type="checkbox"/>	<input type="checkbox"/>	<input type="checkbox"/>	<input type="checkbox"/>	<input type="checkbox"/>	<input type="checkbox"/>
----------------	--------------------------	--------------------------	--------------------------	--------------------------	--------------------------	--------------------------	--------------------------	--------------------------	--------------------------

Standard Base Configuration:

4 x 6W flashing Xenon corners with dummy modules to front and rear.

OR

4 x 6W third generation flashing LED corners with dummy modules to front and rear.

Example Configuration DB5 1430 (56"):

Front: 2 x LED Modules, 2 x Split Modules with dichroic work lamps, 1 x Illuminated Module.



Rear: 5 x LED Modules.

Please advise 12V or 24V when ordering.

<p>LED Modules Amber, blue, red or white.</p> 	<p>Illuminated Modules</p> 	<p>Lettering Service</p> 
---	--	--

<p>Alley Lights</p> 	<p>20W & 35W Worklights</p> 
---	---

Other options include:
LED stop/tail/indicator modules.
Flashing Halogens.



Certified to EMC directive 95/54.

Certified to ECE R65.

High voltage transient and polarity reversal protection fitted.
Operating temperature: -20° to + 55°C.



HI-Wave Delta 980



HI-Wave Delta 1200



HI-Wave Xenergy 1110



HI-Wave Xenergy 1360

Features:
A range of dual function bars with amber Xenon strobe end modules and amber LED rear-facing modules. Offers 3 traffic directing sequences and 5 high visibility warning flash patterns. Supplied with remote control unit with cradle for dash mounting.

- Dual voltage 12/24V (10.5 – 30Vdc)
- Standard and low-profile versions
- 8 flash patterns
- Real-time flash pattern display on controller
- Low power consumption
- High reliability ultra bright LEDs and Xenon strobe tubes
- 12 months' guarantee

Controller Features:

- Backlit pattern selector
- Fitted with 5m cable, with extension available
- Independent switch for end / corner strobes

Flash Patterns:

- 3 directional patterns and 5 high visibility warning flash patterns

Materials:

Polycarbonate lens covers,
aluminium extrusions.

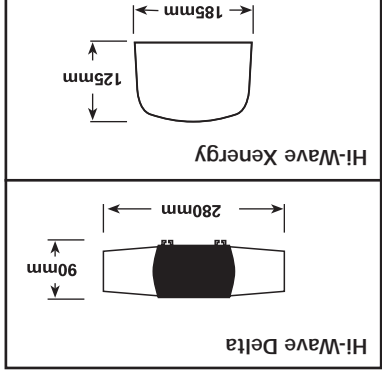

Model	Part No.	Length	Description
HI-Wave Delta 980	880011	980mm	6 rear facing LED blocks + 4 Xenon 6W corner strobe modules
HI-Wave Delta 1200	880012	1200mm	8 rear facing LED blocks + 4 Xenon 6W corner strobe modules
HI-Wave Xenergy 1110	491030	1110mm	6 rear facing LED blocks + 2 Xenon end strobes
HI-Wave Xenergy 1360	491040	1360mm	8 rear facing LED blocks + 2 Xenon end strobes
HI-Wave Extension Cable	521095	5m	Extension cable



Beacon Accessories

Reference	Description	Part Number	Alpha Star	Beta Star	Zeta Star	Lunar Star	Solar Star	Turbo Star	Durastrobe	Rearguard	Hedgehog	Husky Pup	Husky Pup2	Orion
FX60	Mag Kit/Cable/Cigar DIN Plug	521036	✓											
FX11	Triple Mag Kit	521022			✓	✓								
FX7	Single Bolt Kit	521015			✓	✓						✓		
FX12	Single Bolt Kit	521019					✓							
FX13	Pole Mount Kit	521024			✓	✓	✓					✓		
FX30	Flexible Pole Mount Kit	521048			✓	✓	✓						✓	
FX21	Pole Mount Connector – Female	521035					✓							
FX14	Mounting Bracket	521018			✓	✓	✓					✓	✓	
FX16	Backing Plate	521027			✓	✓	✓							
FX9	Protector Guard	521033			✓							✓	✓	
FX37	Protector Guard	521053				✓								
FX10	Protector Guard	521021				✓								
FX23	Protector Guard	521040					✓						✓	
FX24	Surface / Side Entry Kit	521043						✓					✓	
FX35	Pole Mount Connector – Female Threaded	521055			✓	✓								



Beacon & Light Bar Spare Parts

Beacons and Mini Light Bars

Product	Beacon	Clear / None	Amber	Red	Blue	Green
RB Lens Kit	Alpha/Beta/Delta/Durastrobe/Gamma/Husky/Husky Pup.	517001	517002	517052	517053	517005
SO Lens Kit	Rearguard	517091	517092	517093	517094	517095
EL Lens Kit	Turbo Star	517021	517021	517023	517027	517025
SC Lens Kit	Solar Star	-	517010	-	517011	-
ZB Lens Kit	Zeta Star	-	517122	517123	517124	517125
LB Lens Kit	Lunar Star	-	517122	-	517124	-
Orion Lens Kit	Orion	517126	-	-	-	-
PU Lens Kit	Pup2	517127	-	-	-	-
Hedgehog Lens Kit	Hedgehog	517102	517102	517103	-	-
Pulsar Lens Kit	Pulsar	-	517032	517034	-	-
Replacement Circuit	Alpha Star/Husky Pup/Pup2	570013	-	-	-	-
Replacement Circuit	Beta Star	568005	-	-	-	-
Replacement Tube	Delta Star	570009	-	-	-	-
Replacement Tube	Husky	569016	-	-	-	-
Replacement Tube	Solar Star, Turbo Star	570080	-	-	-	-
Replacement Tube	Zeta Star	593005	-	-	-	-
Replacement Tube	Lunar Star	593001	-	-	-	-

Delta Bars

Product	Clear	Amber	Red	Blue	Green	Opal	12V	24V
12W double face xenon module	400050	400051	400052	400053	-	-	-	-
6W double face xenon module	400055	400056	400057	400058	-	-	-	-
Xenon corner module slave	400031	-	400032	-	-	-	-	-
Xenon corner module master	400041	-	400042	-	-	-	-	-
LED face module	400076	400078	400077	-	-	-	-	-
LED corner module	400035	-	400036	-	-	-	-	-
Alley light kit	-	-	-	-	-	-	400004	400005
Illumination	-	-	-	-	-	-	400070	400075
Work light kit - single left	-	-	-	-	-	-	400080	400090
Work light kit - single right	-	-	-	-	-	-	400085	400095
Work light xenon left - no bulb	-	-	-	-	-	-	400060	400060
Work light xenon right - no bulb	-	-	-	-	-	-	400061	400061
Coloured infill	-	053134	-	-	-	-	-	-
Coloured inserts	-	053132	053130	053131	-	-	-	-
Corner lens kit	400020	400021	400022	400023	400024	400026	-	-
Face lens kit	400010	400011	400012	400013	400014	400016	-	-

Xenergy Bars

Product	Clear / None	Amber	Red	Blue	Opal	Silver	Black
Replacement end assembly	490109	-	-	-	-	-	-
Replacement tube - end assembly	490108	-	-	-	-	-	-
Replacement end cover	490101	490102	-	490103	-	-	-
Replacement centre cover	490121	490122	-	490123	490124	-	-
Replacement double length centre cover	517111	517112	-	517114	517113	-	-
Replacement triple length centre cover	517115	517116	-	517118	517117	-	-
Replacement end strap	-	-	-	-	490118	490119	490117
Replacement end strap	-	-	-	-	490128	490129	490127
Directional strobe	490131	490132	490134	490133	-	-	-
Replacement stop/tail assembly 12V	490140	-	-	-	-	-	-
Replacement stop/tail assembly 24V	490142	-	-	-	-	-	-
Replacement indicator assembly 12V	490141	-	-	-	-	-	-
Replacement indicator assembly 24V	490143	-	-	-	-	-	-

Features:

- All models supplied without bulbs ready for your choice of 12V or 24V use
 - Symmetric standard lenses
 - Free form dye cast aluminium reflectors
 - 30mm brackets – upright mount
- Materials:**
- Fibreglass reinforced nylon housing, gold passivated carbon steel bracket.



Model	Part No.	Bulb 12V (not supplied)	Bulb 24V (not supplied)	Bulbs Required	Spade Connectors*
Series 115	PW 115 SP	H3 12V 55W	H3 24V 70W	1	6.35mm (1/4")
Series 1010	PW 1010 SP	H3 12V 55W	H3 24V 70W	1	6.35mm (1/4")
Series 1014	PW 1014 SP	H3 12V 55W	H3 24V 70W	1	6.35mm (1/4")
Series 1117	PW 1117 SP	H3 12V 55W	H3 24V 70W	2	6.35mm (1/4")

* Deutsch DT connector available as an option.



Series 115

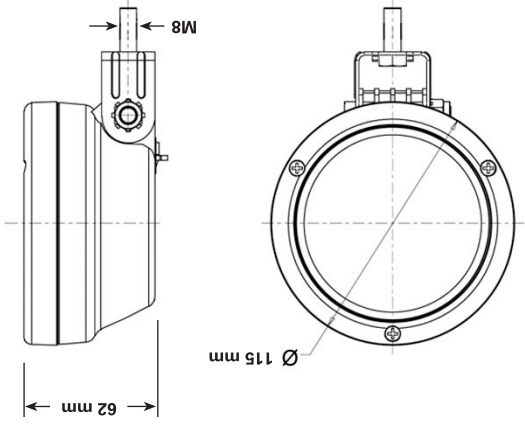



Series 1117 TWIN BULB

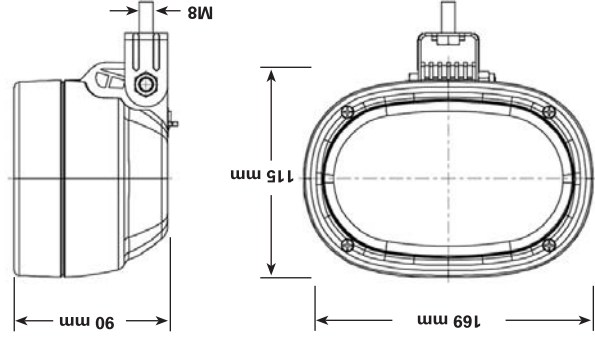

Series 1014

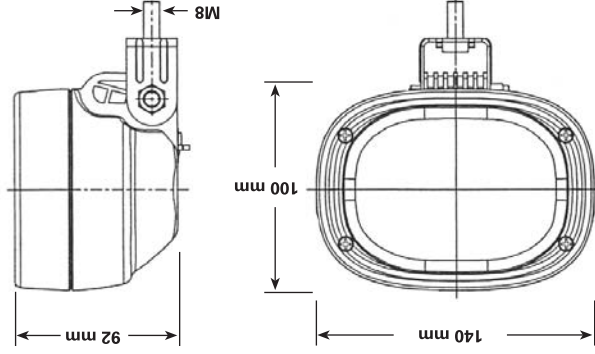

Series 1010

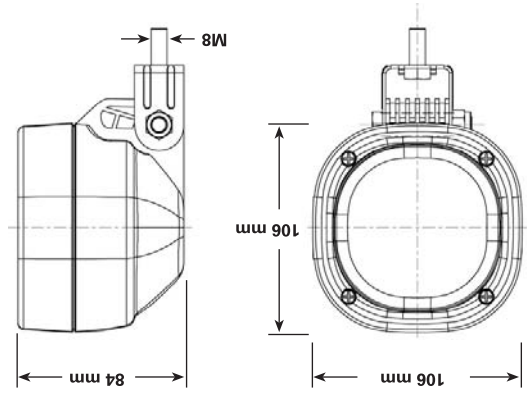

How to Find Us

To Sales & Admin Unit – Kings Park

Leave M25 at Junction 20. From the roundabout take the A4251 exit towards Kings Langley. (Take care not to take the A41 Bypass).

After 400m you reach a mini roundabout, turn right here (2nd exit) onto the Home Park Mill Link Road (signposted Home Park Industrial Estate).

You will cross the canal and shortly arrive at a T junction where you should turn left.

Continue past some factory buildings and the petrol station. After a further 400m, turn left into the Kings Park Estate. Delta is to be found at Unit 1.

Delta Design

1 Kings Park Industrial Estate,

Primrose Hill

Kings Langley

Herts WD4 8ST

Tel: +44 1923 272850

To Manufacturing and Purchasing Unit – Happy Valley

Leave M25 at Junction 20. From the roundabout take the A4251 exit

towards Kings Langley. (Take care not to take the A41 Bypass).

After 400m you reach a mini roundabout, turn right here (2nd exit) onto the Home Park Mill Link Road (signposted Home Park Industrial Estate).

You will cross the canal and shortly arrive at a T junction where you should turn left.

Continue past some factory buildings and the petrol station. After a further 500m, turn left into the Industrial Estate marked Happy Valley Industrial Park. Delta is to be found at Unit 3.

Delta Design

Unit 3 Happy Valley Industrial Park

Primrose Hill

Kings Langley

Herts WD4 8HD

Tel: +44 1923 260802

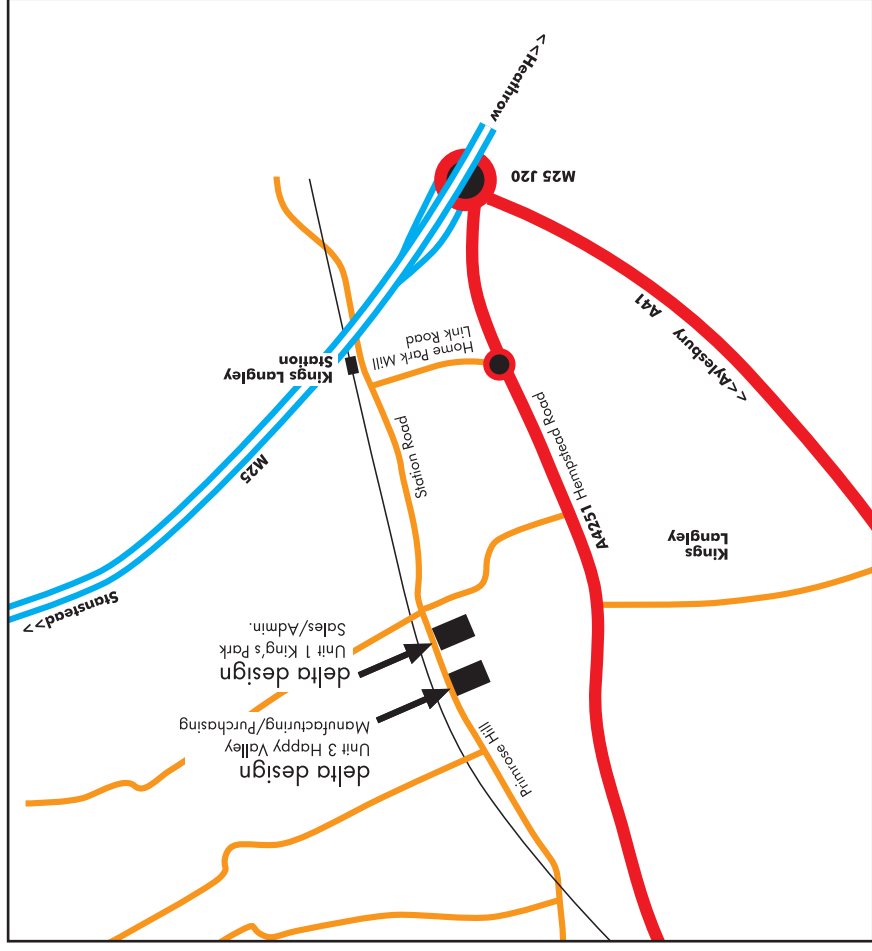

automotive, off-road and battery powered vehicles

product reference catalogue 2007/8



... advanced warning technology



delta design

a division of NICOTECH Limited

Primrose Hill, Kings Langley, Herts WD4 8ST, England.

Tel: (U.K.) 01923 272850 (Int.) +44 1923 272850
 Fax: (U.K.) 01923 260167 (Int.) +44 1923 260167
 E-mail: sales@deltadesign.co.uk
 Web: www.deltadesign.co.uk



delta design

a division of NICOTECH Limited

www.deltadesign.co.uk

X-ON Electronics

Largest Supplier of Electrical and Electronic Components

Click to view similar products for [Delta manufacturer](#):

Other Similar products are found below :

[FFB1324EHE](#) [MKEL-DRB](#) [PL01S2412A](#) [PS75-12VDC-PULL-CONT](#) [1316038K66E000](#) [DOP-EXI014RAE](#) [DRP048V240W1BN](#) [DSVP10-VITON-DIAPHRAGM](#) [DTB4824LV](#) [DTB4848LV](#) [DTB4896CR](#) [DTB4896VRE](#) [DTB9696CVE](#) [DTB9696LVE](#) [DVP01PU-S](#) [DVP06XA-S](#) [DVP08SN11T](#) [DVP08SP11R](#) [DVDPNET-SL](#) [DVPDT01-S](#) [EFB0405VHD](#) [EFB0412HHA](#) [166F-3PDT-13A-24VDC](#) [BUE-20015](#) [IFD8520](#) [1-NPO/603-1339](#) [20114-80](#) [20310-80](#) [21022-82](#) [900-\(1C\)-30A-12VDC](#) [S24SP15003PDFA](#) [LNE-12V185WAAA](#) [LNE-24V100WDAA](#) [LNE-36V185WAAA](#) [LNE-54V185WDAA](#) [166-DPDT-13A-6VDC](#) [ADP485-01](#) [FFB1212VHE-F00](#) [1-NPO/603-1326](#) [20243-81](#) [PFR0612XHE-SP00](#) [23595-73](#) [PMC-12V150W1BA](#) [PMH-24V150WCBA](#) [CME-COP01](#) [31000-82](#) [310-4PDT-10A-110VAC](#) [32003-81](#) [32007-82](#) [32007-84](#)