

DELPHI SERIES

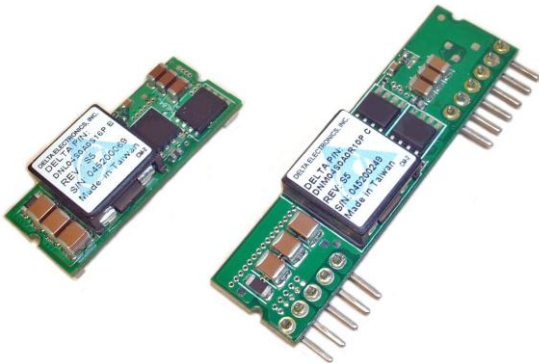

FEATURES

- ◆ High efficiency: 95% @ 5.0V_{in}, 3.3V/16A out
- ◆ Small size and low profile: (SMD) 33.0x 13.5x 8.8mm (1.30" x 0.53" x 0.35")
- ◆ Surface mount packaging
- ◆ Standard footprint
- ◆ Voltage and resistor-based trim
- ◆ Pre-bias startup
- ◆ Output voltage tracking
- ◆ No minimum load required
- ◆ Output voltage programmable from 0.75V_{dc} to 3.63V_{dc} via external resistor
- ◆ Fixed frequency operation (300KHz)
- ◆ Input UVLO, output OTP, OCP
- ◆ Remote ON/OFF
- ◆ Remote sense
- ◆ ISO 9001, TL 9000, ISO 14001, QS9000, OHSAS18001 certified manufacturing facility
- ◆ UL/cUL 60950-1 (US & Canada) Recognized

Delphi DNL, Non-Isolated Point of Load DC/DC Power Modules: 2.8-5.5V_{in}, 0.75-3.63V/16A out

The Delphi series DNL, 2.8-5.5V input, single output, non-isolated point of load DC/DC converters are the latest offering from a world leader in power systems technology and manufacturing — Delta Electronics, Inc. The DNL series provides a programmable output voltage from 0.75V to 3.63V by using an external resistor. The DNL converters have flexible and programmable tracking and sequencing features to enable a variety of startup voltages as well as sequencing and tracking between power modules. This product family is available in a surface mount or SIP package and provides 16A of current in an industry standard footprint. With creative design technology and optimization of component placement, these converters possess outstanding electrical and thermal performance and extremely high reliability under highly stressful operating conditions.

OPTIONS

- ◆ Negative On/Off logic
- ◆ Tracking feature
- ◆ Single-In-Line (SIP) packaging

APPLICATIONS

- ◆ Telecom / DataCom
- ◆ Distributed power architectures
- ◆ Servers and workstations
- ◆ LAN / WAN applications
- ◆ Data processing applications

DATASHEET
DS_DNL04SMD16_07182012

TECHNICAL SPECIFICATIONS

($T_A = 25^\circ\text{C}$, airflow rate = 300 LFM, $V_{in} = 2.8\text{Vdc}$ and 5.5Vdc , nominal V_{out} unless otherwise noted.)

| PARAMETER | NOTES and CONDITIONS | DNL04S0A0S16PFD | | | |
|--|--|-----------------|-------------|--------------|----------------------|
| | | Min. | Typ. | Max. | Units |
| ABSOLUTE MAXIMUM RATINGS | | | | | |
| Input Voltage (Continuous) | | 0 | | 5.8 | Vdc |
| Tracking Voltage | | | | $V_{in,max}$ | Vdc |
| Operating Temperature | | -40 | | 85 | $^\circ\text{C}$ |
| Storage Temperature | | -55 | | 125 | $^\circ\text{C}$ |
| INPUT CHARACTERISTICS | | | | | |
| Operating Input Voltage | $V_o \leq V_{in} - 0.5$ | 2.8 | | 5.5 | V |
| Input Under-Voltage Lockout | | | | | |
| Turn-On Voltage Threshold | | | 2.2 | | V |
| Turn-Off Voltage Threshold | | | 2.0 | | V |
| Maximum Input Current | $V_{in}=2.8\text{V}$ to 5.5V , $I_o=I_o,max$ | | | 16 | A |
| No-Load Input Current | | | 70 | | mA |
| Off Converter Input Current | | | 5 | | mA |
| Inrush Transient | $V_{in}=2.8\text{V}$ to 5.5V , $I_o=I_o,min$ to I_o,max | | | 0.1 | A^2S |
| Recommended Inout Fuse | | | | 20 | A |
| OUTPUT CHARACTERISTICS | | | | | |
| Output Voltage Set Point | $V_{in}=5\text{V}$, $I_o=I_o,max$ | -2.0 | $V_{o,set}$ | +2.0 | % $V_{o,set}$ |
| Output Voltage Adjustable Range | | 0.7525 | | 3.63 | V |
| Output Voltage Regulation | | | | | |
| Over Line | $V_{in}=2.8\text{V}$ to 5.5V | | 0.3 | | % $V_{o,set}$ |
| Over Load | $I_o=I_o,min$ to I_o,max | | 0.4 | | % $V_{o,set}$ |
| Over Temperature | $T_a=-40^\circ\text{C}$ to 85°C | | 0.8 | | % $V_{o,set}$ |
| Total Output Voltage Range | Over sample load, line and temperature | -3.0 | | +3.0 | % $V_{o,set}$ |
| Output Voltage Ripple and Noise | 5Hz to 20MHz bandwidth | | | | |
| Peak-to-Peak | Full Load, 1 μF ceramic, 10 μF tantalum | | 25 | 50 | mV |
| RMS | Full Load, 1 μF ceramic, 10 μF tantalum | | 8 | 15 | mV |
| Output Current Range | | 0 | | 16 | A |
| Output Voltage Over-shoot at Start-up | $V_{out} = 3.3\text{V}$ | | | 1 | % $V_{o,set}$ |
| Output DC Current-Limit Inception | | | 220 | | % I_o |
| Output Short-Circuit Current (Hiccup Mode) | $I_o,s/c$ | | 3.5 | | Adc |
| DYNAMIC CHARACTERISTICS | | | | | |
| Dynamic Load Response | 10 μF Tan & 1 μF Ceramic load cap, 2.5A/ μs | | | | |
| Positive Step Change in Output Current | 50% I_o,max to 100% I_o,max | | 300 | | mV |
| Negative Step Change in Output Current | 100% I_o,max to 50% I_o,max | | 300 | | mV |
| Settling Time to 10% of Peak Deviation | | | 25 | | μs |
| Turn-On Transient | $I_o=I_o,max$ | | | | |
| Start-Up Time, From On/Off Control | $V_{on/off}$, $V_o=10\%$ of $V_{o,set}$ | | 4 | | ms |
| Start-Up Time, From Input | $V_{in}=V_{in,min}$, $V_o=10\%$ of $V_{o,set}$ | | 4 | | ms |
| Output Voltage Rise Time | Time for V_o to rise from 10% to 90% of $V_{o,set}$ | | 4 | 8 | ms |
| Output Capacitive Load | Full load; ESR $\geq 1\text{m}\Omega$ | | | 1000 | μF |
| | Full load; ESR $\geq 10\text{m}\Omega$ | | | 5000 | μF |
| EFFICIENCY | | | | | |
| $V_o=3.3\text{V}$ | $V_{in}=5\text{V}$, 100% Load | | 95.0 | | % |
| $V_o=2.5\text{V}$ | $V_{in}=5\text{V}$, 100% Load | | 93.0 | | % |
| $V_o=1.8\text{V}$ | $V_{in}=5\text{V}$, 100% Load | | 91.0 | | % |
| $V_o=1.5\text{V}$ | $V_{in}=5\text{V}$, 100% Load | | 89.5 | | % |
| $V_o=1.2\text{V}$ | $V_{in}=5\text{V}$, 100% Load | | 88.0 | | % |
| $V_o=0.75\text{V}$ | $V_{in}=5\text{V}$, 100% Load | | 83.0 | | % |
| FEATURE CHARACTERISTICS | | | | | |
| Switching Frequency | | | 300 | | kHz |
| ON/OFF Control, (Negative logic) | | | | | |
| Logic Low Voltage | Module On, $V_{on/off}$ | -0.2 | | 0.3 | V |
| Logic High Voltage | Module Off, $V_{on/off}$ | 1.5 | | $V_{in,max}$ | V |
| Logic Low Current | Module On, $I_{on/off}$ | | | 10 | μA |
| Logic High Current | Module Off, $I_{on/off}$ | | 0.2 | 1 | mA |
| ON/OFF Control, (Positive Logic) | | | | | |
| Logic High Voltage | Module On, $V_{on/off}$ | | | $V_{in,max}$ | V |
| Logic Low Voltage | Module Off, $V_{on/off}$ | -0.2 | | 0.3 | V |
| Logic High Current | Module Off, $I_{on/off}$ | | | 10 | μA |
| Logic High Voltage | Module On, $V_{on/off}$ | | | $V_{in,max}$ | V |
| Tracking Slew Rate Capability | | 0.1 | | 2 | V/msec |
| Tracking Delay Time | Delay from $V_{in,min}$ to application of tracking voltage | 10 | | | ms |
| Tracking Accuracy | Power-up 2V/mS | | 100 | 200 | mV |
| | Power-down 1V/mS | | 200 | 400 | mV |
| Remote Sense Range | | | | 0.1 | V |
| GENERAL SPECIFICATIONS | | | | | |
| MTBF | $I_o=80\%I_o,max$; $T_a=25^\circ\text{C}$ | | 14.39 | | M hours |
| Weight | | | 8 | | grams |
| Over-Temperature Shutdown | Refer to Figure 45 for measuring point | | 130 | | $^\circ\text{C}$ |



ELECTRICAL CHARACTERISTICS CURVES

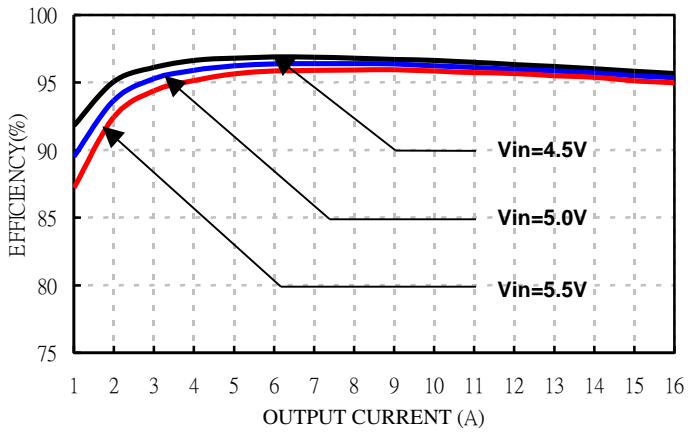

Figure 1: Converter efficiency vs. output current (3.3V out)

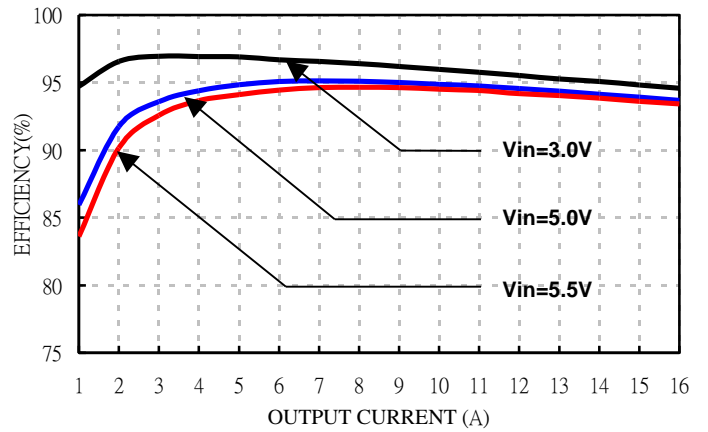

Figure 2: Converter efficiency vs. output current (2.5V out)

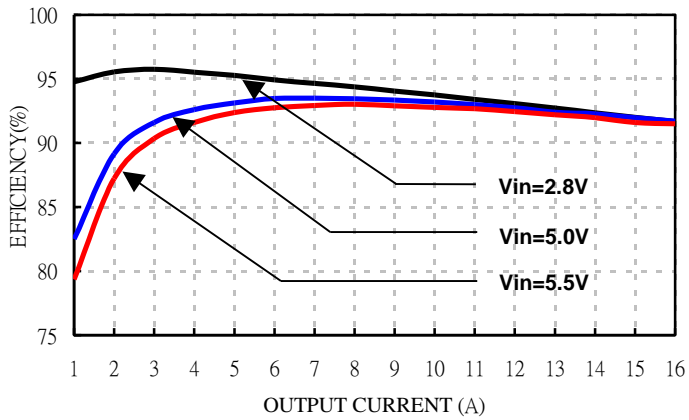

Figure 3: Converter efficiency vs. output current (1.8V out)

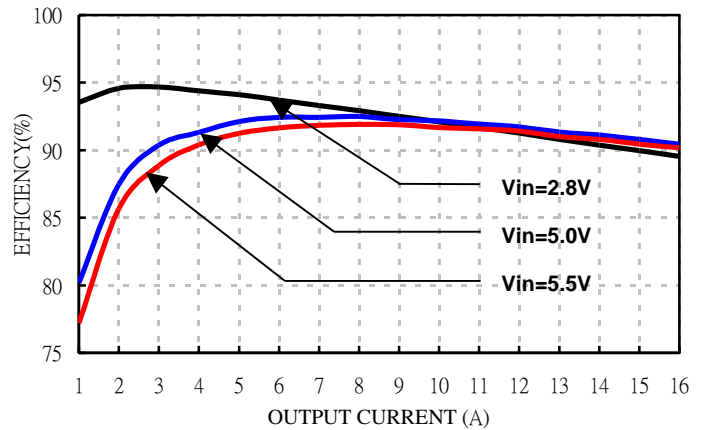

Figure 4: Converter efficiency vs. output current (1.5V out)

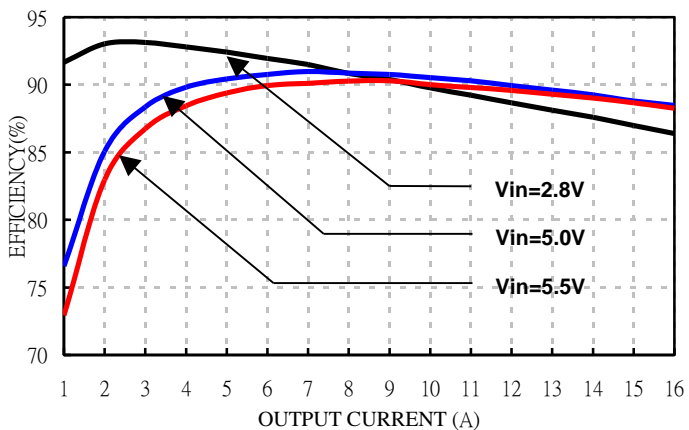

Figure 5: Converter efficiency vs. output current (1.2V out)

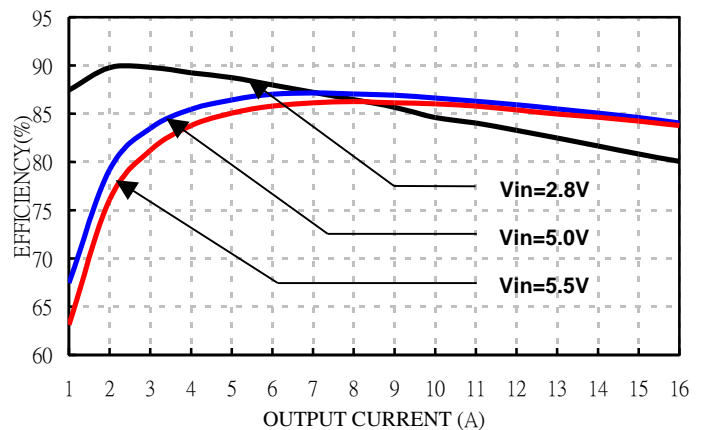

Figure 6: Converter efficiency vs. output current (0.75V out)



ELECTRICAL CHARACTERISTICS CURVES

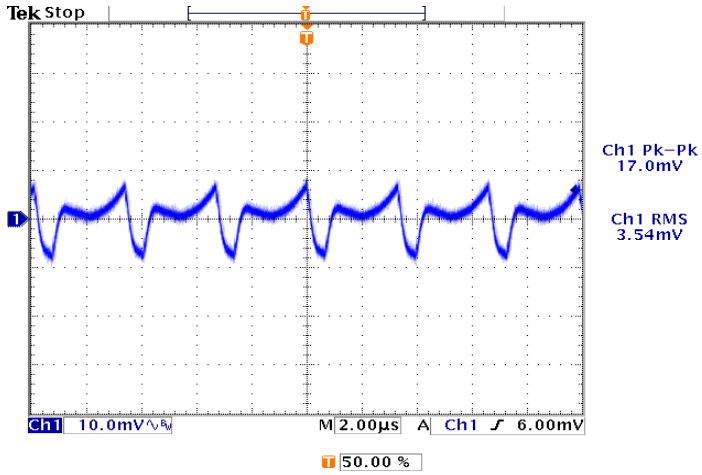

Figure 7: Output ripple & noise at 3.3Vin, 2.5V/16A out

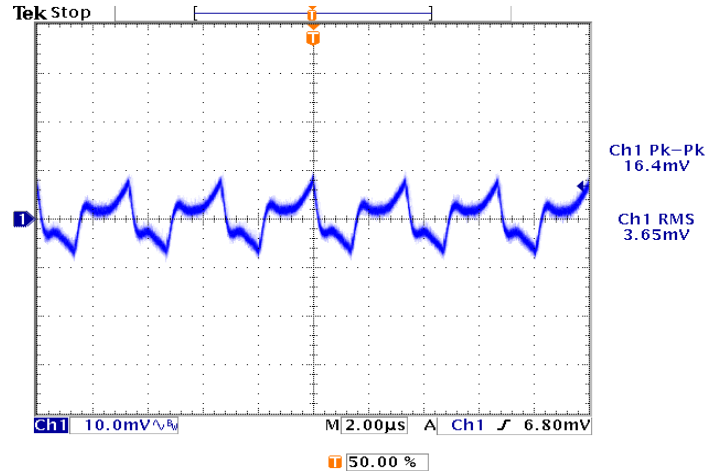

Figure 8: Output ripple & noise at 3.3Vin, 1.8V/16A out

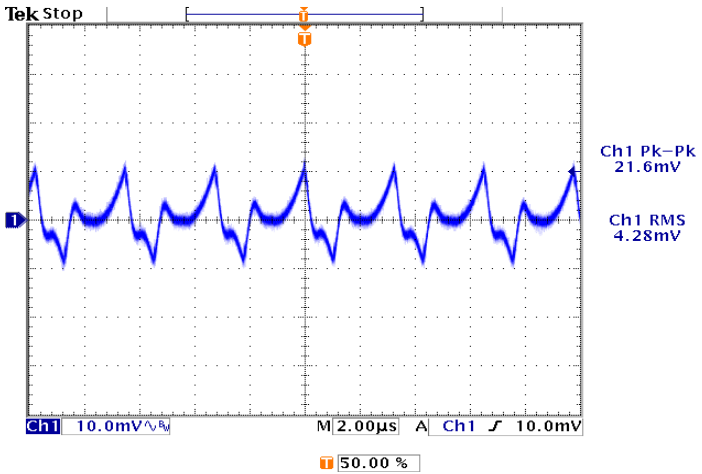

Figure 9: Output ripple & noise at 5Vin, 3.3V/16A out

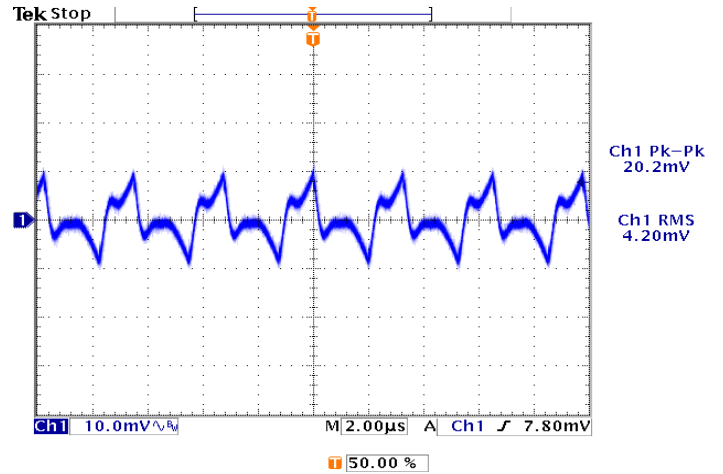

Figure 10: Output ripple & noise at 5Vin, 1.8V/16A out

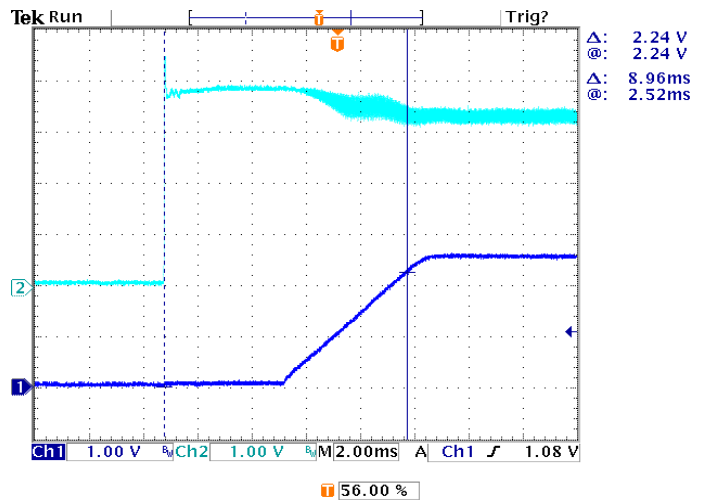

Figure 11: Turn on delay time at input turn on 3.3Vin, 2.5V/16A out

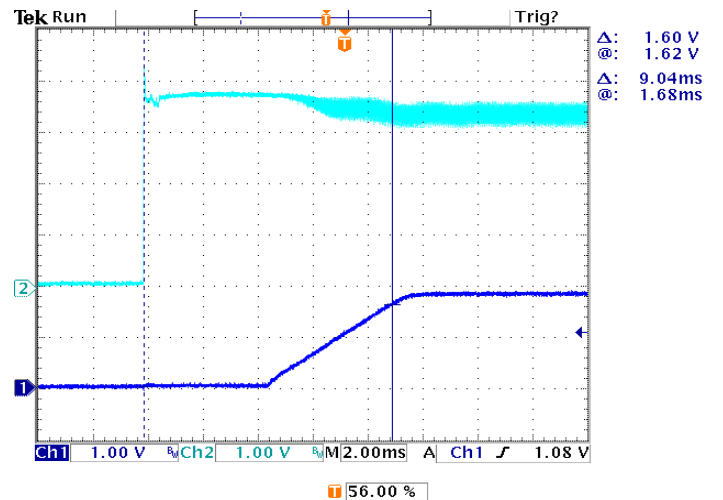

Figure 12: Turn on delay time at input turn on 3.3Vin, 1.8V/16A out



ELECTRICAL CHARACTERISTICS CURVES

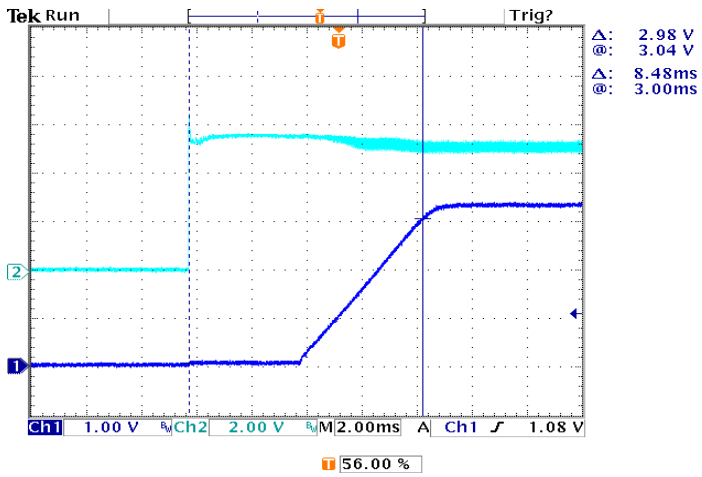

Figure 13: Turn on delay time at input turn on 5Vin, 3.3V/16A out

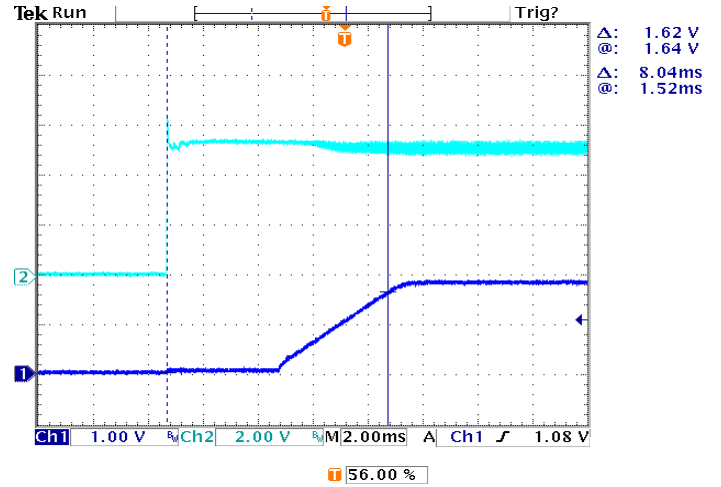

Figure 14: Turn on delay time at input turn on 5Vin, 1.8V/16A out

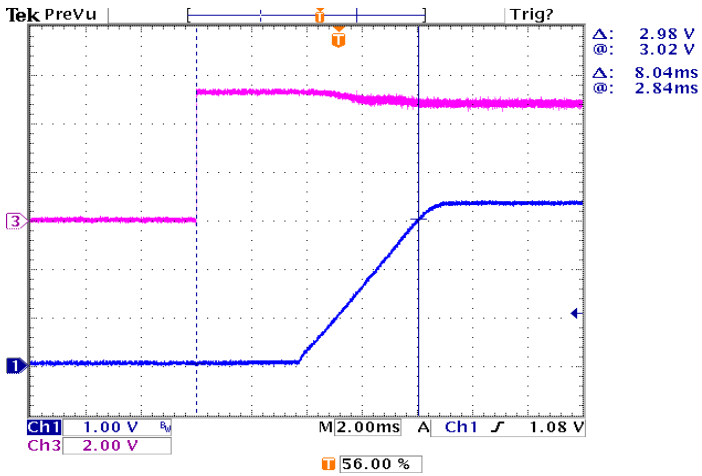

Figure 15: Turn on delay time at remote turn on 5Vin, 3.3V/16A out

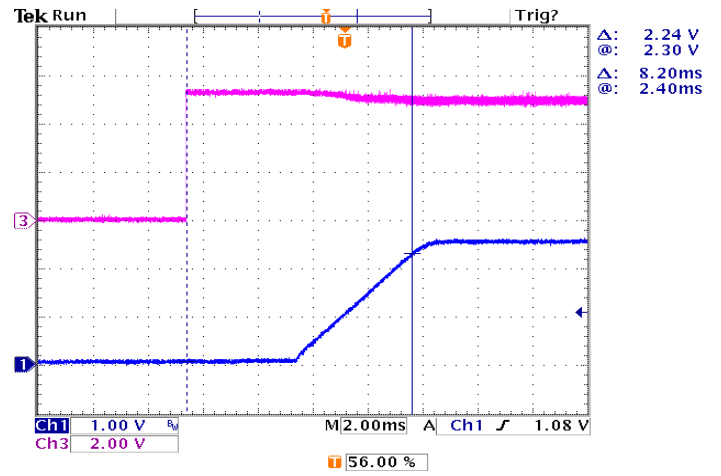

Figure 16: Turn on delay time at remote turn on 3.3Vin, 2.5V/16A out

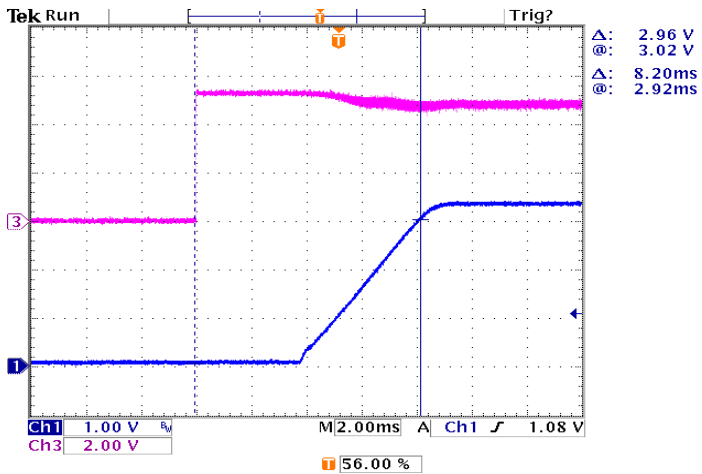

Figure 17: Turn on delay time at remote turn on with external capacitors (Co= 5000 μF) 5Vin, 3.3V/16A out

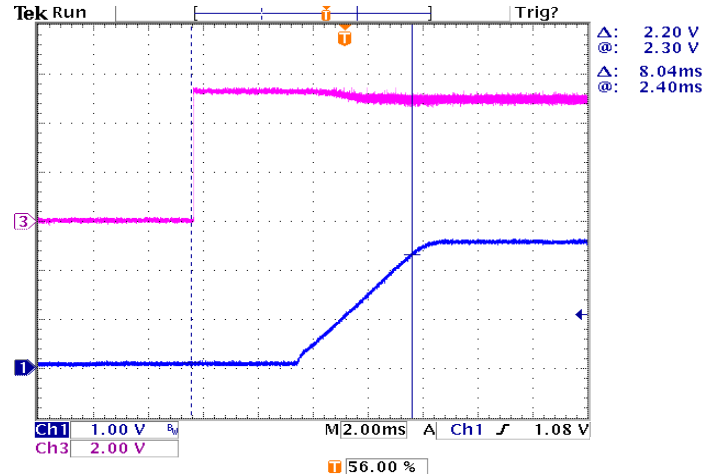

Figure 18: Turn on delay time at remote turn on with external capacitors (Co= 5000 μF) 3.3Vin, 2.5V/16A out

ELECTRICAL CHARACTERISTICS CURVES

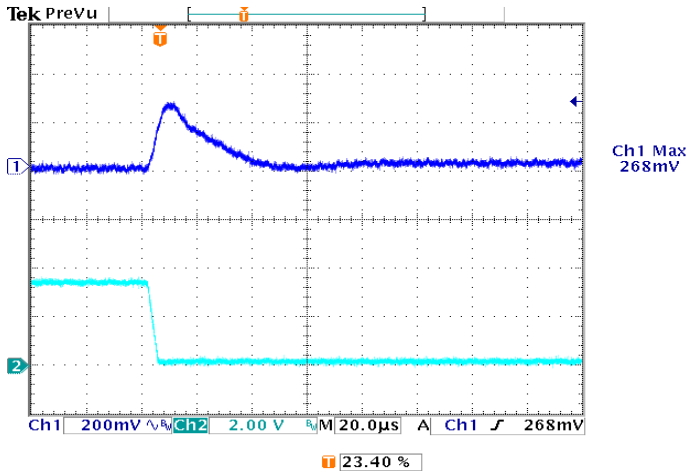

Figure 19: Typical transient response to step load change at 2.5A/µS from 100% to 50% of I_o , max at 5Vin, 3.3V out (Cout = ceramic, 10µF tantalum)

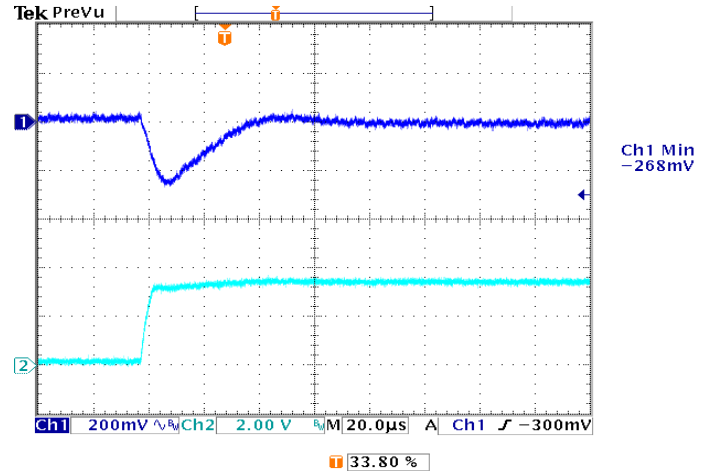

Figure 20: Typical transient response to step load change at 2.5A/µS from 50% to 100% of I_o , max at 5Vin, 3.3V out (Cout = ceramic, 10µF tantalum)

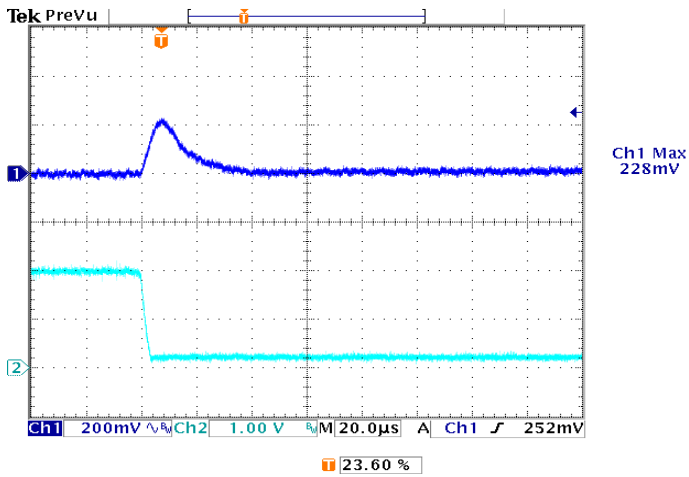

Figure 21: Typical transient response to step load change at 2.5A/µS from 100% to 50% of I_o , max at 5Vin, 1.8V out (Cout = ceramic, 10µF tantalum)

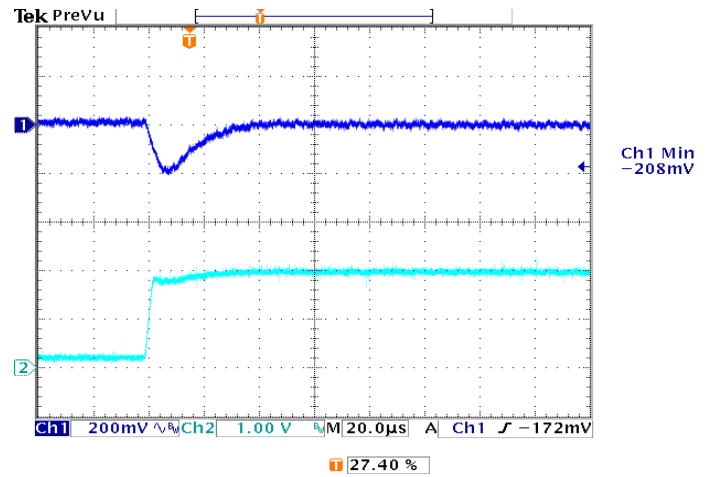

Figure 22: Typical transient response to step load change at 2.5A/µS from 50% to 100% of I_o , max at 5Vin, 1.8V out (Cout = ceramic, 10µF tantalum)



ELECTRICAL CHARACTERISTICS CURVES

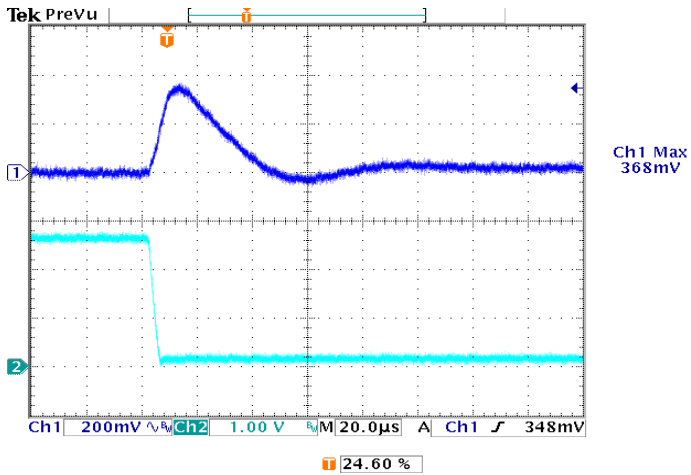

Figure 23: Typical transient response to step load change at 2.5A/µS from 100% to 50% of I_o , max at 3.3Vin, 2.5V out (Cout = ceramic, 10µF tantalum)

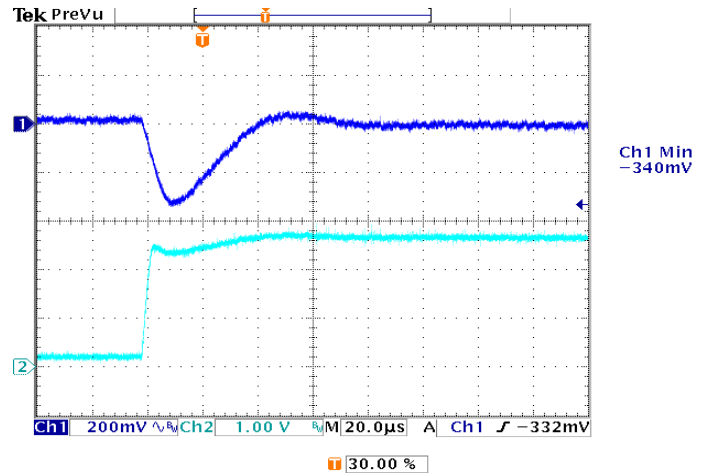

Figure 24: Typical transient response to step load change at 2.5A/µS from 50% to 100% of I_o , max at 3.3Vin, 2.5V out (Cout = ceramic, 10µF tantalum)

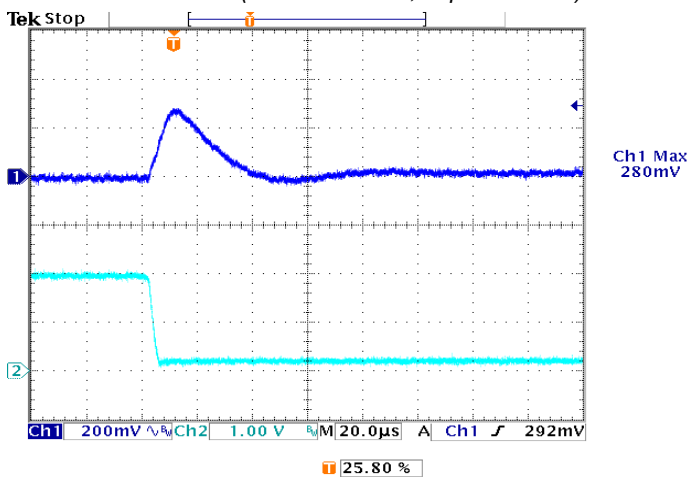

Figure 25: Typical transient response to step load change at 2.5A/µS from 100% to 50% of I_o , max at 3.3Vin, 1.8V out (Cout = ceramic, 10µF tantalum)

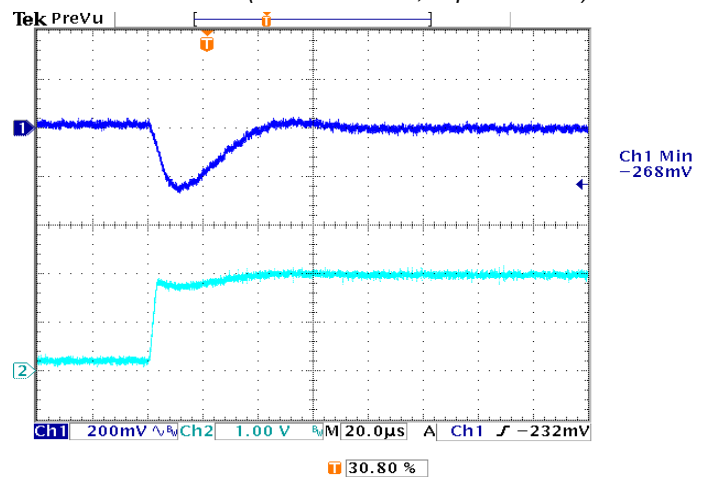

Figure 26: Typical transient response to step load change at 2.5A/µS from 50% to 100% of I_o , max at 3.3Vin, 1.8V out (Cout = ceramic, 10µF tantalum)

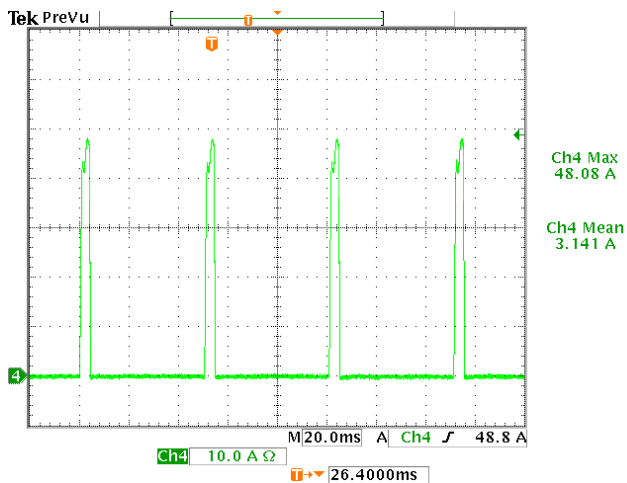

Figure 27: Output short circuit current 5Vin, 0.75Vout

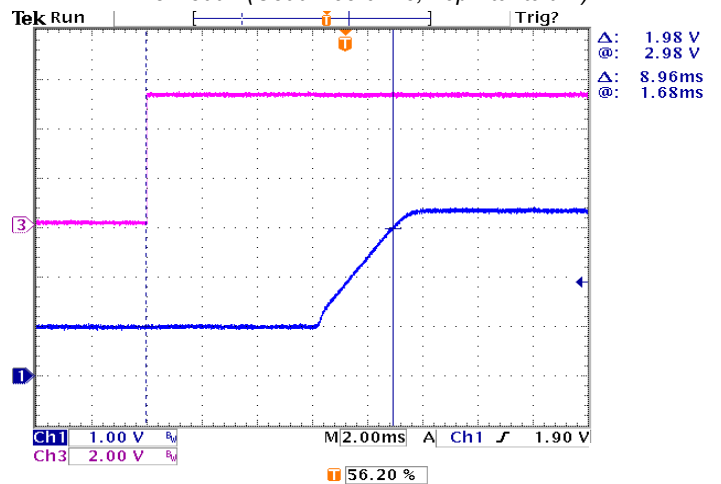
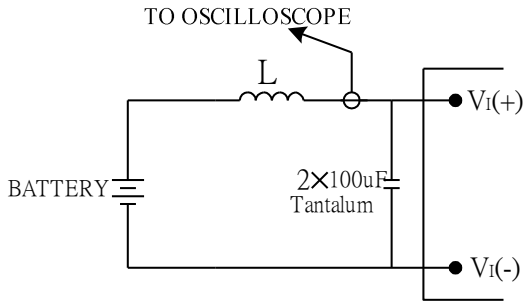

Figure 28: Turn on with Prebias 5Vin, 3.3V/0A out, Vbias = 1.0Vdc

TEST CONFIGURATIONS



Note: Input reflected-ripple current is measured with a simulated source inductance. Current is measured at the input of the module.

Figure 29: Input reflected-ripple test setup

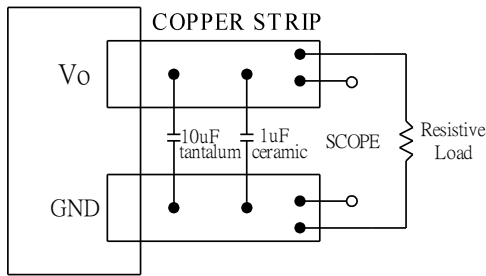

Note: Use a 10µF tantalum and 1µF capacitor. Scope measurement should be made using a BNC cable.

Figure 30: Peak-peak output noise and startup transient measurement test setup.

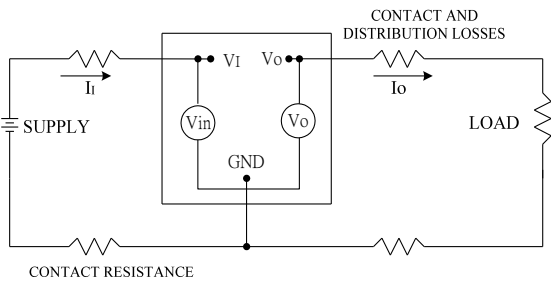

Figure 31: Output voltage and efficiency measurement test setup

Note: All measurements are taken at the module terminals. When the module is not soldered (via socket), place Kelvin connections at module terminals to avoid measurement errors due to contact resistance.

$$\eta = \left(\frac{V_o \times I_o}{V_i \times I_i} \right) \times 100 \%$$

Input Source Impedance

To maintain low noise and ripple at the input voltage, it is critical to use low ESR capacitors at the input to the module. Figure 32 shows the input ripple voltage (mVp-p) for various output models using 200 µF (2 x 100µF) low ESR tantalum capacitor (KEMET p/n: T491D107M016AS, AVX p/n: TAJD107M106R, or equivalent) in parallel with 47 µF ceramic capacitor (TDK p/n:C5750X7R1C476M or equivalent). Figure 33 shows much lower input voltage ripple when input capacitance is increased to 400 µF (4 x 100 µF) tantalum capacitors in parallel with 94 µF (2 x 47 µF) ceramic capacitor.

The input capacitance should be able to handle an AC ripple current of at least:

$$I_{rms} = I_{out} \sqrt{\frac{V_{out}}{V_{in}} \left(1 - \frac{V_{out}}{V_{in}} \right)} \quad A_{rms}$$

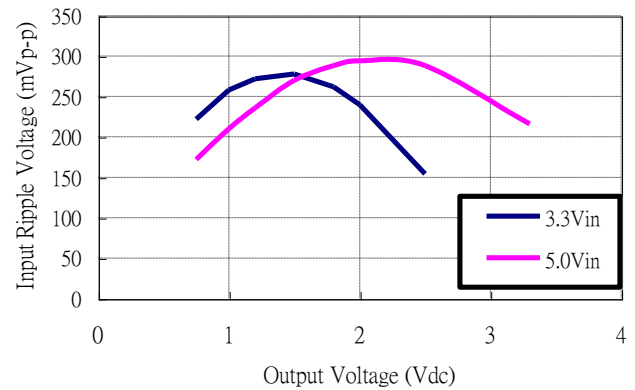

Figure 32: Input voltage ripple for various output models, IO = 16 A (CIN = 2x100 µF tantalum // 47 µF ceramic)

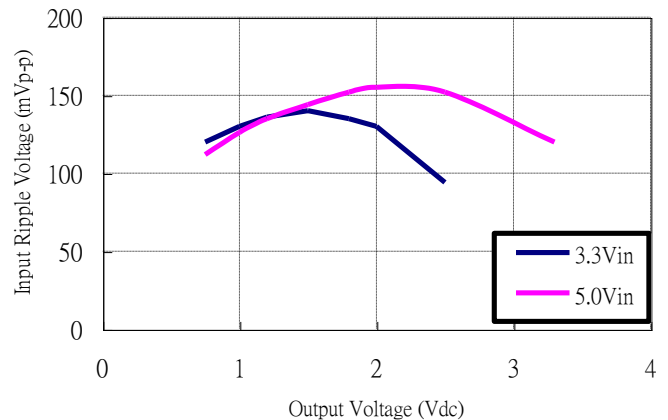

Figure 33: Input voltage ripple for various output models, IO = 16 A (CIN = 4x100 µF tantalum // 2x47 µF ceramic)

DESIGN CONSIDERATIONS (CON.)

The power module should be connected to a low ac-impedance input source. Highly inductive source impedances can affect the stability of the module. An input capacitance must be placed close to the modules input pins to filter ripple current and ensure module stability in the presence of inductive traces that supply the input voltage to the module.

Safety Considerations

For safety-agency approval the power module must be installed in compliance with the spacing and separation requirements of the end-use safety agency standards.

For the converter output to be considered meeting the requirements of safety extra-low voltage (SELV), the input must meet SELV requirements. The power module has extra-low voltage (ELV) outputs when all inputs are ELV.

The input to these units is to be provided with a maximum 20A of glass type fast-acting fuse in the ungrounded lead.

FEATURES DESCRIPTIONS

Remote On/Off

The DNM/DNL series power modules have an On/Off pin for remote On/Off operation. Both positive and negative On/Off logic options are available in the DNM/DNL series power modules.

For positive logic module, connect an open collector (NPN) transistor or open drain (N channel) MOSFET between the On/Off pin and the GND pin (see figure 34). Positive logic On/Off signal turns the module ON during the logic high and turns the module OFF during the logic low. When the positive On/Off function is not used, leave the pin floating or tie to V_{in} (module will be On).

For negative logic module, the On/Off pin is pulled high with an external pull-up 5k Ω resistor (see figure 35). Negative logic On/Off signal turns the module OFF during logic high and turns the module ON during logic low. If the negative On/Off function is not used, leave the pin floating or tie to GND. (module will be On)

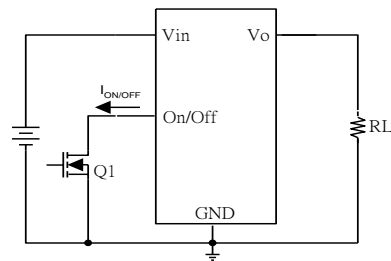

Figure 34: Positive remote On/Off implementation

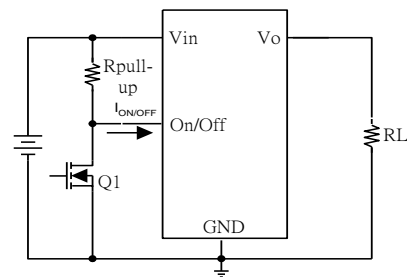

Figure 35: Negative remote On/Off implementation

Over-Current Protection

To provide protection in an output over load fault condition, the unit is equipped with internal over-current protection. When the over-current protection is triggered, the unit enters hiccup mode. The units operate normally once the fault condition is removed.



FEATURES DESCRIPTIONS (CON.)

Over-Temperature Protection

The over-temperature protection consists of circuitry that provides protection from thermal damage. If the temperature exceeds the over-temperature threshold the module will shut down. The module will try to restart after shutdown. If the over-temperature condition still exists during restart, the module will shut down again. This restart trial will continue until the temperature is within specification

Remote Sense

The DNM/DNL provide V_o remote sensing to achieve proper regulation at the load points and reduce effects of distribution losses on output line. In the event of an open remote sense line, the module shall maintain local sense regulation through an internal resistor. The module shall correct for a total of 0.5V of loss. The remote sense line impedance shall be $< 10\Omega$.

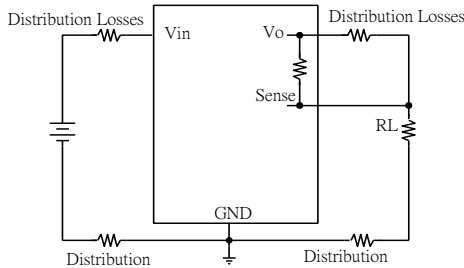

Figure 36: Effective circuit configuration for remote sense operation

Output Voltage Programming

The output voltage of the DNM/DNL can be programmed to any voltage between 0.75Vdc and 3.63Vdc by connecting one resistor (shown as R_{trim} in Figure 37) between the TRIM and GND pins of the module. Without this external resistor, the output voltage of the module is 0.7525 Vdc. To calculate the value of the resistor R_{trim} for a particular output voltage V_o , please use the following equation:

$$R_{trim} = \left[\frac{21070}{V_o - 0.7525} - 5110 \right] \Omega$$

For example, to program the output voltage of the DNL module to 1.8Vdc, R_{trim} is calculated as follows:

$$R_{trim} = \left[\frac{21070}{1.8 - 0.7525} - 5110 \right] \Omega = 15K\Omega$$

DNL can also be programmed by apply a voltage between the TRIM and GND pins (Figure 38). The following equation can be used to determine the value of V_{trim} needed for a desired output voltage V_o :

DS_DNL04SMD16A_07182012

$$V_{trim} = 0.7 - 0.1698 \times (V_o - 0.7525)$$

For example, to program the output voltage of a DNL module to 3.3 Vdc, V_{trim} is calculated as follows

$$V_{trim} = 0.7 - 0.1698 \times (3.3 - 0.7525) = 0.267V$$

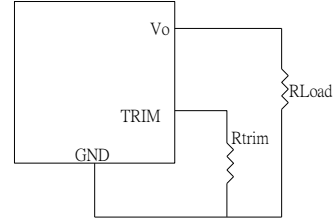

Figure 37: Circuit configuration for programming output voltage using an external resistor

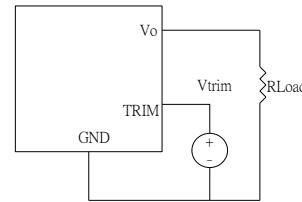

Figure 38: Circuit Configuration for programming output voltage using external voltage source

Table 1 provides R_{trim} values required for some common output voltages, while Table 2 provides value of external voltage source, V_{trim} , for the same common output voltages. By using a 1% tolerance trim resistor, set point tolerance of $\pm 2\%$ can be achieved as specified in the electrical specification.

Table 1

| $V_o(V)$ | $R_{trim}(K\Omega)$ |
|----------|---------------------|
| 0.7525 | Open |
| 1.2 | 41.97 |
| 1.5 | 23.08 |
| 1.8 | 15.00 |
| 2.5 | 6.95 |
| 3.3 | 3.16 |
| 3.63 | 2.21 |

Table 2

| $V_o(V)$ | $V_{trim}(V)$ |
|----------|---------------|
| 0.7525 | Open |
| 1.2 | 0.624 |
| 1.5 | 0.573 |
| 1.8 | 0.522 |
| 2.5 | 0.403 |
| 3.3 | 0.267 |
| 3.63 | 0.211 |

FEATURE DESCRIPTIONS (CON.)

The amount of power delivered by the module is the voltage at the output terminals multiplied by the output current. When using the trim feature, the output voltage of the module can be increased, which at the same output current would increase the power output of the module. Care should be taken to ensure that the maximum output power of the module must not exceed the maximum rated power ($V_{o.set} \times I_{o.max} \leq P_{max}$).

Voltage Margining

Output voltage margining can be implemented in the DNL modules by connecting a resistor, $R_{margin-up}$, from the Trim pin to the ground pin for margining-up the output voltage and by connecting a resistor, $R_{margin-down}$, from the Trim pin to the output pin for margining-down. Figure 39 shows the circuit configuration for output voltage margining. If unused, leave the trim pin unconnected. A calculation tool is available from the evaluation procedure which computes the values of $R_{margin-up}$ and $R_{margin-down}$ for a specific output voltage and margin percentage.

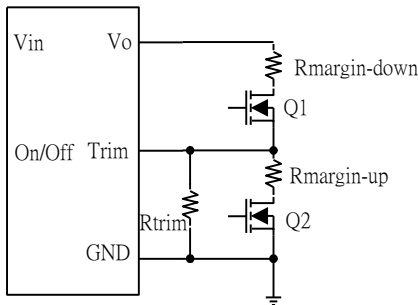

Figure 39: Circuit configuration for output voltage margining

Voltage Tracking

The DNL family was designed for applications that have output voltage tracking requirements during power-up and power-down. The devices have a TRACK pin to implement three types of tracking method: sequential start-up, simultaneous and ratio-metric. TRACK simplifies the task of supply voltage tracking in a power system by enabling modules to track each other, or any external voltage, during power-up and power-down.

By connecting multiple modules together, customers can get multiple modules to track their output voltages to the voltage applied on the TRACK pin.

The output voltage tracking feature (Figure 40 to Figure 42) is achieved according to the different external connections. If the tracking feature is not used, the TRACK pin of the module can be left unconnected or tied to V_{in} .

For proper voltage tracking, input voltage of the tracking power module must be applied in advance, and the remote on/off pin has to be in turn-on status. (Negative logic: Tied to GND or unconnected. Positive logic: Tied to V_{in} or unconnected)

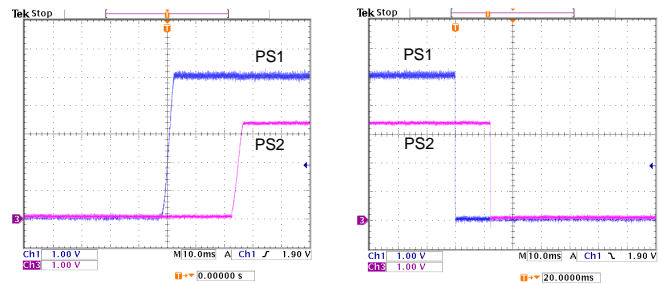

Figure 40: Sequential

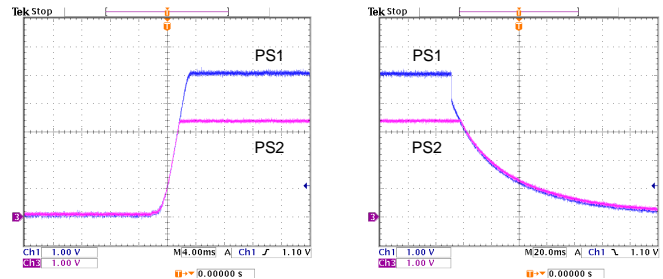

Figure 41: Simultaneous

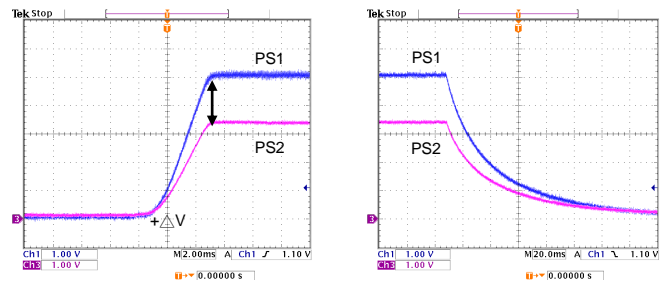
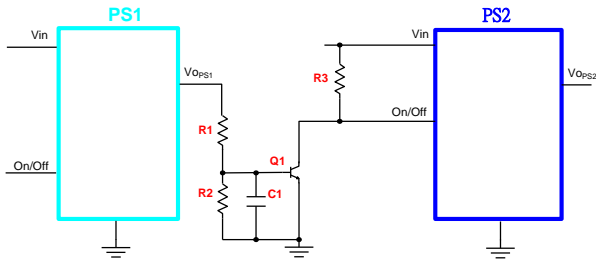

Figure 42: Ratio-metric

FEATURE DESCRIPTIONS (CON.)

Sequential Start-up

Sequential start-up (Figure 40) is implemented by placing an On/Off control circuit between $V_{O_{PS1}}$ and the On/Off pin of PS2.



Simultaneous

Simultaneous tracking (Figure 41) is implemented by using the TRACK pin. The objective is to minimize the voltage difference between the power supply outputs during power up and down.

The simultaneous tracking can be accomplished by connecting $V_{O_{PS1}}$ to the TRACK pin of PS2. Please note the voltage apply to TRACK pin needs to always higher than the $V_{O_{PS2}}$ set point voltage.

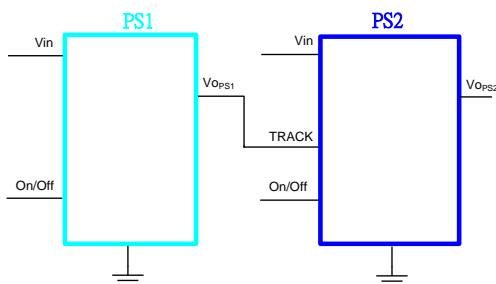

Ratio-Metric

Ratio-metric (Figure 42) is implemented by placing the voltage divider on the TRACK pin that comprises R_1 and R_2 , to create a proportional voltage with $V_{O_{PS1}}$ to the Track pin of PS2.

For Ratio-Metric applications that need the outputs of PS1 and PS2 reach the regulation set point at the same time

The following equation can be used to calculate the value of R_1 and R_2 .

The suggested value of R_2 is 10k Ω .

$$\frac{V_{o,PS2}}{V_{o,PS1}} = \frac{R_2}{R_1 + R_2}$$

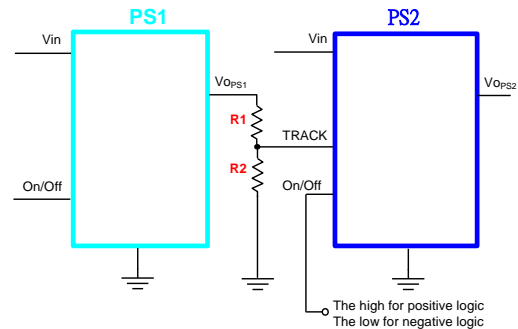

THERMAL CONSIDERATIONS

Thermal management is an important part of the system design. To ensure proper, reliable operation, sufficient cooling of the power module is needed over the entire temperature range of the module. Convection cooling is usually the dominant mode of heat transfer.

Hence, the choice of equipment to characterize the thermal performance of the power module is a wind tunnel.

Thermal Testing Setup

Delta's DC/DC power modules are characterized in heated vertical wind tunnels that simulate the thermal environments encountered in most electronics equipment. This type of equipment commonly uses vertically mounted circuit cards in cabinet racks in which the power modules are mounted.

The following figure shows the wind tunnel characterization setup. The power module is mounted on a test PWB and is vertically positioned within the wind tunnel. The height of this fan duct is constantly kept at 25.4mm (1").

Thermal Derating

Heat can be removed by increasing airflow over the module. To enhance system reliability, the power module should always be operated below the maximum operating temperature. If the temperature exceeds the maximum module temperature, reliability of the unit may be affected.

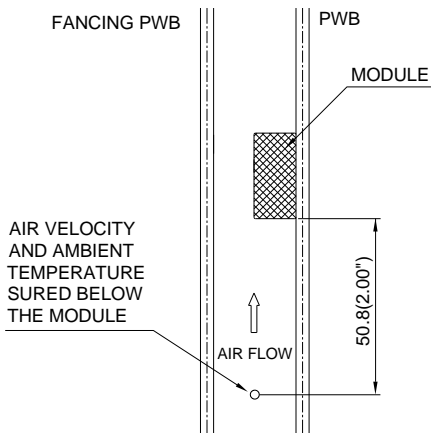

Note: Wind Tunnel Test Setup Figure Dimensions are in millimeters and (Inches)

Figure 44: Wind tunnel test setup

THERMAL CURVES

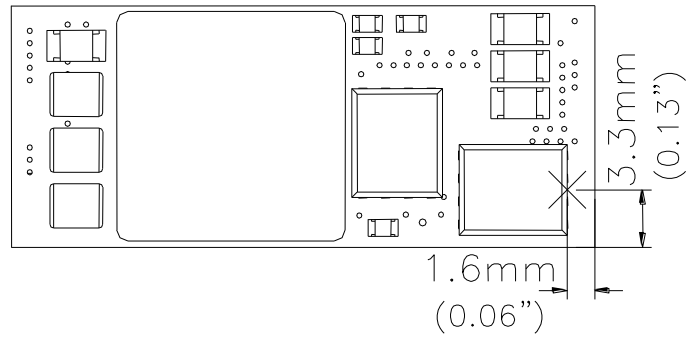

Figure 45: Hot spot temperature measured point

*The allowed maximum hot spot temperature is defined at 125°C

*The over-temperature shutdown is 130°C.

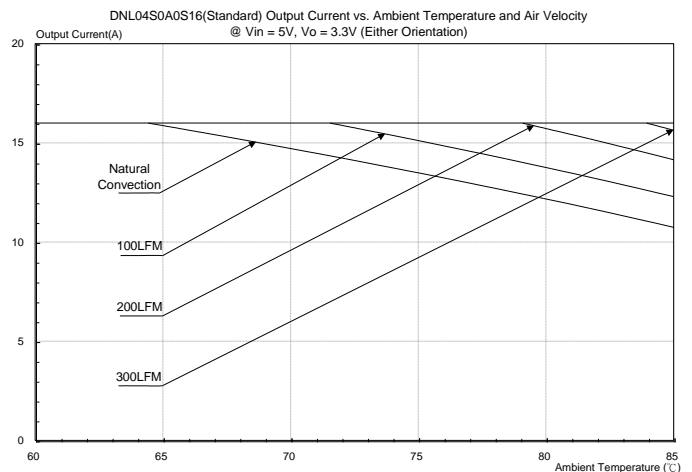

Figure 46: DNL04S0A0S16 output current vs. ambient temperature and air velocity @Vin=5V, Vo=3.3V(Either Orientation)

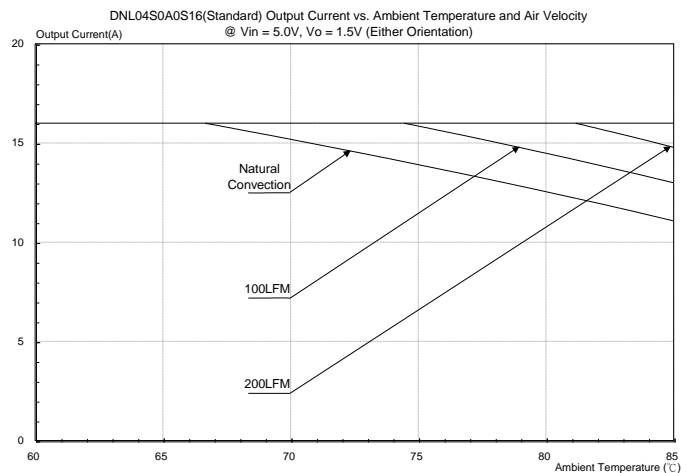

Figure 47: DNL04S0A0S16 output current vs. ambient temperature and air velocity @Vin=5V, Vo=1.5V(Either Orientation)



THERMAL CURVES (CON.)

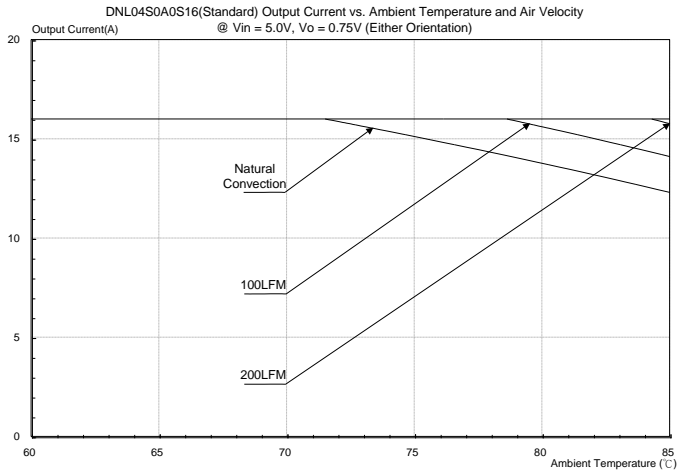

Figure 48: DNL04S0A0S16(Standard) output current vs. ambient temperature and air velocity @Vin=5V, Vo=0.75V(Either Orientation).

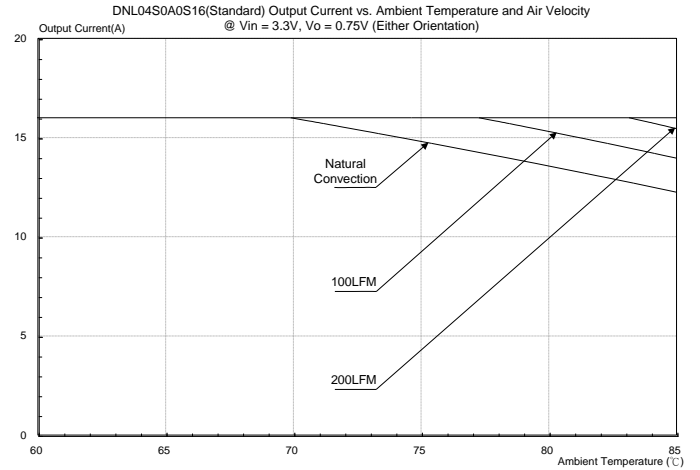

Figure 51: DNL04S0A0S16(Standard) output current vs. ambient temperature and air velocity @Vin=3.3V, Vo=0.75V(Either Orientation).

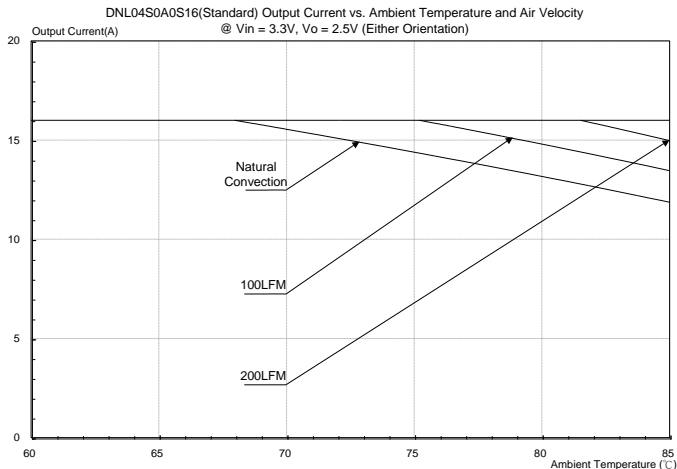

Figure 49: DNL04S0A0S16(Standard) output current vs. ambient temperature and air velocity @Vin=3.3V, Vo=2.5V(Either Orientation).

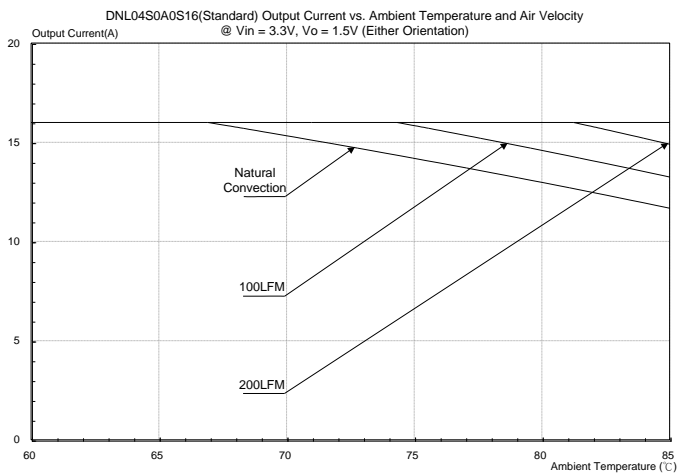
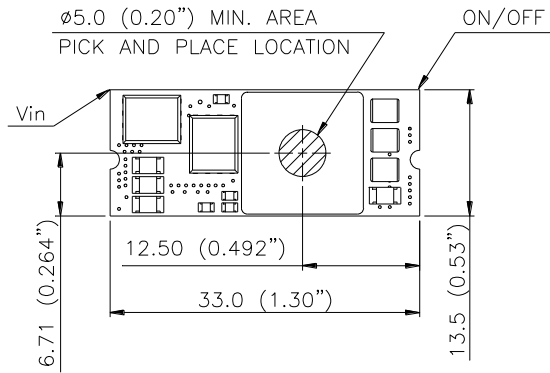

Figure 50: DNL04S0A0S16(Standard) output current vs. ambient temperature and air velocity @Vin=3.3V, Vo=1.5V(Either Orientation).

DS_DNL04SMD16A_07182012



PICK AND PLACE LOCATION



NOTES:
 ALL DIMENSIONS ARE IN MILLIMETERS AND (INCHES)
 TOLERANCES: X.Xmm±0.5mm(X.XX in.±0.02 in.)
 X.XXmm±0.25mm(X.XXX in.±0.010 in.)

SURFACE-MOUNT TAPE & REEL

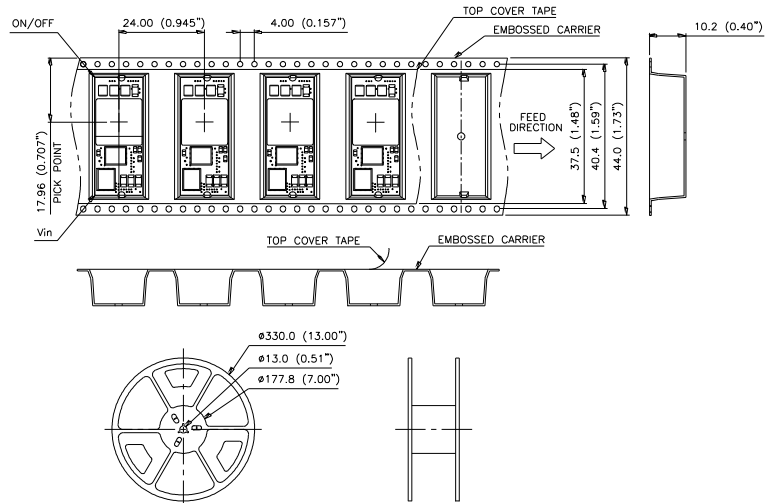

LEAD (Sn/Pb) PROCESS RECOMMEND TEMP. PROFILE

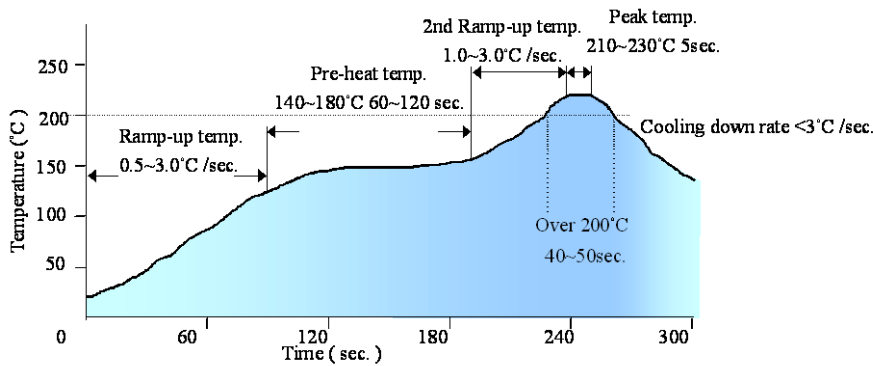

LEAD FREE (SAC) PROCESS RECOMMEND TEMP. PROFILE

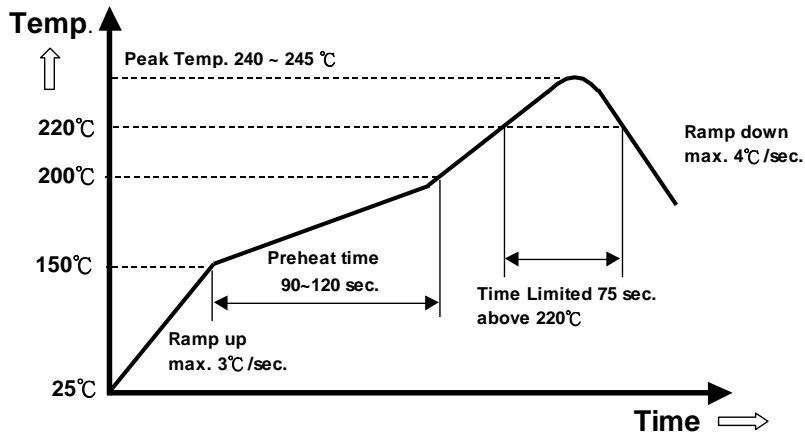

Note: All temperature refers to assembly application board, measured on the land of assembly application board.

MECHANICAL DRAWING

SMD PACKAGE

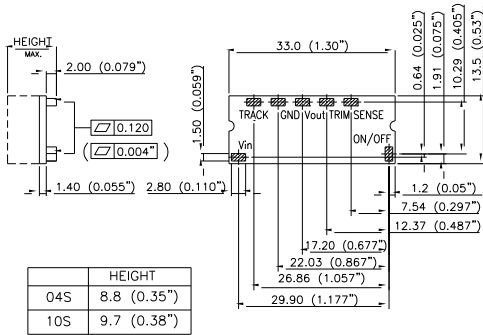

SIDE VIEW

BOTTOM VIEW

SIP PACKAGE (OPTIONAL)

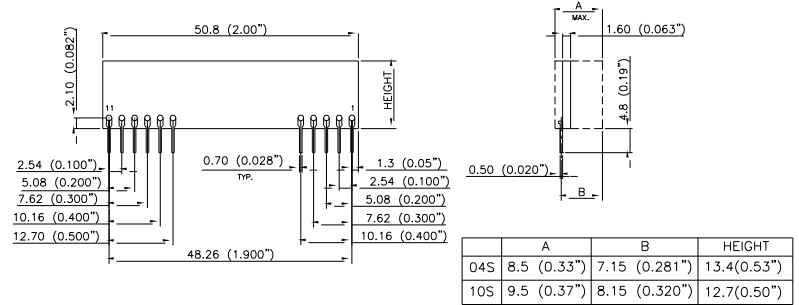

BACK VIEW

SIDE VIEW

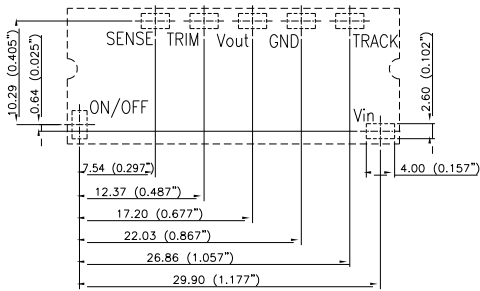

RECOMMENDED P.W.B. PAD LAYOUT

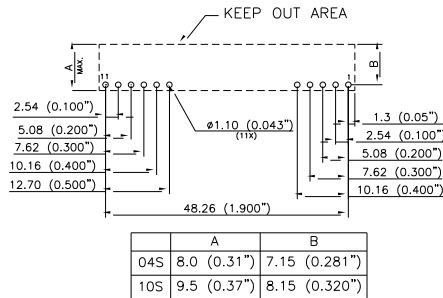

RECOMMENDED P.W.B. PAD LAYOUT

| PIN# | Function |
|------|----------|
| 1 | Vo |
| 2 | Vo |
| 3 | Vo SENSE |
| 4 | Vo |
| 5 | GND |
| 6 | GND |
| 7 | Vi |
| 8 | Vi |
| 9 | TRACK |
| 10 | TRIM |
| 11 | ON/OFF |

NOTES:
 DIMENSIONS ARE IN MILLIMETERS AND (INCHES)
 TOLERANCES: X.Xmm±0.5mm(X.XX in.±0.02 in.)
 X.XXmm±0.25mm(X.XXX in.±0.010 in.)

PART NUMBERING SYSTEM

| DNL | 04 | S | 0A0 | S | 16 | P | F | D |
|------------------------------------|-------------------------------|--------------------|-----------------------|--------------------|-------------------------------|----------------------------|----------------------------|-----------------------|
| Product Series | Input Voltage | Numbers of Outputs | Output Voltage | Package Type | Output Current | On/Off logic | | Option Code |
| DNL – 16A DNM – 10A DNS – 6A | 04 - 2.8~5.5V 10 – 8.3~14V | S - Single | 0A0 - Programmable | R - SIP S - SMD | 16 -16A 10 -10A 06 - 6A | N- negative P- positive | F- RoHS 6/6 (Lead Free) | D - Standard Function |

MODEL LIST

| Model Name | Packaging | Input Voltage | Output Voltage | Output Current | Efficiency 5.0V _{in} @ 100% load |
|-----------------|-----------|---------------|-----------------|----------------|--|
| DNL04S0A0S16PFD | SMD | 2.8 ~ 5.5Vdc | 0.75 ~ 3.63 Vdc | 16A | 95 %(3.3V) |
| DNL04S0A0S16NFD | SMD | 2.8 ~ 5.5Vdc | 0.75 ~ 3.63 Vdc | 16A | 95 %(3.3V) |
| DNL04S0A0R16PFD | SIP | 2.8 ~ 5.5Vdc | 0.75 ~ 3.63 Vdc | 16A | 95 %(3.3V) |
| DNL04S0A0R16NFD | SIP | 2.8 ~ 5.5Vdc | 0.75 ~ 3.63 Vdc | 16A | 95 %(3.3V) |

CONTACT: www.deltaww.com/dc dc

USA:

Telephone:
East Coast: 978-656-3993
West Coast: 510-668-5100
Fax: (978) 656 3964
Email: DCDC@delta-corp.com

Europe:

Telephone: +31-20-655-0967
Fax: +31-20-655-0999
Email: DCDC@delta-es.com

Asia & the rest of world:

Telephone: +886 3 4526107 x6220~6224
Fax: +886 3 4513485
Email: DCDC@delta.com.tw

WARRANTY

Delta offers a two (2) year limited warranty. Complete warranty information is listed on our web site or is available upon request from Delta.

Information furnished by Delta is believed to be accurate and reliable. However, no responsibility is assumed by Delta for its use, nor for any infringements of patents or other rights of third parties, which may result from its use. No license is granted by implication or otherwise under any patent or patent rights of Delta. Delta reserves the right to revise these specifications at any time, without notice.

X-ON Electronics

Largest Supplier of Electrical and Electronic Components

Click to view similar products for [Non-Isolated DC/DC Converters](#) category:

Click to view products by [Delta](#) manufacturer:

Other Similar products are found below :

[PSR152.5-7IR](#) [APTH003A0X-SRZ](#) [SPM1004-3V3C](#) [R-785.0-05](#) [10E24-P15-10PPM](#) [1E24-P4-25PPM-SHV-5KV](#) [PROPOWER-3.3V](#)
[MYGTM01210BZN](#) [40C24-N250-I5-H](#) [40A24-P30-E](#) [3V12-P0.8](#) [10C24-N250-I10-AQ-DA](#) [4AA24-P20-M-H](#) [3V12-N0.8](#) [3V24-P1](#) [3V24-](#)
[N1](#) [BMR4672010/001](#) [BMR4652010/001](#) [6AA24-P30-I5-M](#) [6AA24-N30-I5-M](#) [BM2P101X-Z](#) [35A24-P30](#) [2.5M24-P1](#) [PTV03010WAD](#)
[PTV05020WAH](#) [PTV12010LAH](#) [PTV12020WAD](#) [R-7212D](#) [R-7212P](#) [R-78AA15-0.5SMD](#) [R-78AA5.0-1.0SMD](#) [30A24-N15-E](#) [10A12-P4-](#)
[M](#) [10C24-N250-I5](#) [10C24-P125](#) [10C24-P250-I5](#) [6A24-P20-I10-F-M-25PPM](#) [1A24-P30-F-M-C](#) [TSR 1-24150SM](#) [1/2AA24-N30-I10](#) [1C24-](#)
[N125](#) [12C24-N250](#) [V7806-1500](#) [PTV12020LAH](#) [PTV05010WAH](#) [PTN04050CAZT](#) [PTH12020WAD](#) [PTH12020LAS](#) [PTH05050YAH](#)
[PTH05T210WAH](#)