

Sync DIN Rail Power Supply

24V 50W 1 Phase (NEC Class 2) / DRS-24V50W1N□

sync

Highlights & Features

- Ultra-compact size and galvanic isolation up to 3.0kVac between input to output and input to ground
- Universal AC input voltage and full power from -10°C to +55°C operation
- Up to 90.0% efficiency
- Low earth leakage current < 0.5mA @ 264Vac
- Built-in DC OK relay contact option available
- Extreme low temperature cold start at -40°C
- NEC Class 2 / Limited Power Source (LPS) certified
- Certified according to IEC/EN/UL 62368-1

Safety Standards



CB Certified for worldwide use



*This picture is for reference to DRS-24V50W series only.

Model Number: DRS-24V50W1N□
Unit Weight: 0.18 kg (0.40 lb)
Dimensions (L x W x D): 75 x 30 x 89.5 mm
 (2.95 x 1.18 x 3.52 inch)

General Description

The ultra-compact and competitively priced Delta Sync DIN Rail DRS-24V50W1N□ power supply is designed for industrial applications requiring highly reliable power supply that must fit in a small space. The Sync series operates with universal AC input range and offers full power up to 55°C. The output is adjustable from 24-28 volts, and can support up to 3000 microfarads of load capacitance. A green LED indicates output is present. The design is certified according to IEC/EN/UL 60950-1, IEC/EN/UL 62368-1 Information Technology Equipment (ITE) and UL 508 Industrial Control Equipment (ICE). The series is also fully compliant with RoHS Directive 2011/65/EU for environmental protection. NEC Class 2 and Limited Power Source (LPS) approvals are available for this product.

Model Information

Sync DIN Rail Power Supply

Model Number	Input Voltage Range	Rated Output Voltage	Rated Output Current
DRS-24V50W1N□	85-264Vac (120-375Vdc)	24Vdc	2.1A

Model Numbering

DR	S -	24V	50W	1	N	□
DIN Rail	Product Series S - Sync Series	Output Voltage	50W series	Single Phase	NEC Class 2	Z - Without DC OK Relay Contact R - With DC OK Relay Contact

Sync DIN Rail Power Supply

24V 50W 1 Phase (NEC Class 2) / DRS-24V50W1N□

Specifications

Input Ratings / Characteristics

Nominal Input Voltage		100-240Vac
Input Voltage Range		85-264Vac
Nominal Input Frequency		50-60Hz
Input Frequency Range		47-63Hz
DC Input Voltage Range*		120-375Vdc
Input Current		< 0.95A @ 115Vac, < 0.55A @ 230Vac
Efficiency at 100% Load		> 89% @ 115Vac, > 90% @ 230Vac
Max Power Dissipation	0% load	< 0.3W @ 115Vac, < 0.5W @ 230Vac
	100% load	< 6W @ 115Vac & 230Vac
Max Inrush Current (Cold Start)		< 30A @ 115Vac, < 50A @ 230Vac
Leakage Current	IEC/EN 60950-1	< 0.5mA @ 264Vac
(Neutral to PE terminal)	IEC/EN 62368-1	< 1.0mA @ 264Vac

*Fulfills test conditions for DC input. Safety approval for DC input can be obtained upon request.

Output Ratings / Characteristics**

Nominal Output Voltage		24Vdc
Factory Set Point Tolerance		24Vdc \pm 2%
Output Voltage Adjustment Range		24-28Vdc
Output Current		2.1A (50W max.)
Output Power		50W
Line Regulation		< 0.5% (@ 85-264Vac, 100% load)
Load Regulation		< 1.0% (@ 85-264Vac, 0-100% load)
PARD*** (20MHz)		< 70mVpp @ > 0°C to 70°C < 100mVpp @ 0°C to -20°C
Rise Time		< 30ms @ nominal input (100% load)
Start-up Time		< 2,000ms @ 115Vac (100% load) < 1,000ms @ 230Vac (100% load)
Hold-up Time		> 20ms @ 115Vac (100% load) > 100ms @ 230Vac (100% load)
Dynamic Response (Overshoot & Undershoot O/P Voltage)		\pm 5% @ 85-264Vac input, 0-100% load (Slew Rate: 0.1A/ μ s, 50% duty cycle @ 5Hz to 1KHz)
Start-up with Capacitive Loads		3,000 μ F Max
Functional	DC OK Relay Contact (for DRS-24V50W1NR)	30V / 1A, resistive load The relay contact are normally "ON" (closed) when the output (Vout) is greater than 75% of its rated value and "OFF" (opened) when the output (Vout) is less than 75% typ.

**For power de-rating from < -10°C to -20°C, and 55°C to 70°C, see power de-rating on page 3.

***PARD is measured with an AC coupling mode, 5cm wires, and in parallel with 0.1 μ F ceramic capacitor & 47 μ F electrolytic capacitor.

Sync DIN Rail Power Supply

24V 50W 1 Phase (NEC Class 2) / DRS-24V50W1N□

Mechanical

Case Cover / Chassis	Plastic	
Dimensions (L x W x D)	75 x 30 x 89.5 mm (2.95 x 1.18 x 3.52 inch)	
Unit Weight	0.18 kg (0.40 lb)	
Indicator	Green LED (DC OK)	
Cooling System	Convection	
Terminal	Input	3 Pins (Rated 300V/16A)
	Output	4 Pins (Rated 300V/16A)
Wire	Input / Output	AWG 22-12 / AWG 20-12
Mounting Rail	Standard TS35 DIN Rail in accordance with EN 60715	
Noise (1 Meter from power supply)	Sound Pressure Level (SPL) < 25dBA	

Environment

Surrounding Air Temperature	Operating	-20°C to +70°C (Cold start at -40°C @ 40% load)
	Storage	-40°C to +85°C
Power De-rating	-10°C to -20°C de-rate power by 2% / °C > 55°C de-rate power by 3.33% / °C	
Operating Humidity	5 to 95% RH (Non-Condensing)	
Operating Altitude	0 to 2,000 Meters (6,560 ft.)	
Shock Test	Non-Operating	IEC60068-2-27, Half Sine Wave: 50G for a duration of 11ms; 3 times per direction, 9 times in total
	Operating	IEC 60068-2-27, Half Sine Wave: 10G for a duration of 11ms; 1 time in X axis
Vibration	Non-Operating	IEC 60068-2-6, Random: 5-500Hz; 2.09G _{rms} , 20 min per axis for all X, Y, Z directions
	Operating	IEC 60068-2-6, Sine Wave: 10-500Hz; 2G peak; displacement of 0.35mm; 1 octave per min; 60 min per axis for all X, Y, Z directions
Pollution Degree	2	

Protections

Overvoltage	< 34.8V, SELV Output, Latch Mode
Overload / Overcurrent	105~120% of rated load current, Foldback Mode (continuous current, voltage drops), Auto-recovery when the fault is removed
Over Temperature	< 75°C Surrounding Air Temperature @ 100% load, Latch Mode
Short Circuit	Hiccup Mode, Non-Latching (Auto-recovery when the fault is removed)
Internal Fuse	T3.15A
Degree of Protection	IP20
Protection Against Shock	Class I with PE* connection

*PE: Primary Earth

Sync DIN Rail Power Supply

24V 50W 1 Phase (NEC Class 2) / DRS-24V50W1N□

Reliability Data

MTBF	Telcordia SR-332	> 700,000 hrs	I/P: 115Vac & 230Vac, O/P: 100% load, Ta: 25°C
	MIL-HDBK-217F	231,000 hrs	I/P: 115Vac & 230Vac, O/P: 100% load, Ta: 25°C
Expected Cap Life Time		10 years (115ac & 230Vac, 50% load @ 40°C)	

Safety Standards / Directives

Safety Entry Low Voltage		SELV (EN 60950)
Electrical Safety	TUV Bauart UL/cUL recognized	EN 60950-1, EN 62368-1 UL 60950-1, UL 62368-1, CSA C22.2 No. 60950-1 (File No. E191395)
	CB Scheme	IEC 60950-1, IEC 62368-1, Limited Power Source (LPS)
Industrial Control Equipment	UL/cUL listed	UL 508 and CSA C22.2 No. 107.1-01 (File No. E315335)
Class 2 Power Supply	UL/cUL recognized	UL 60950-1, UL 62368-1, CSA C22.2 No. 60950-1 (File No. E191395)
CE		In conformance with EMC Directive 2014/30/EU and Low Voltage Directive 2014/35/EU
Material and Parts		RoHS Directive 2011/65/EU Compliant
Galvanic Isolation	Input to Output	3.0KVac
	Input to Ground	3.0KVac
	Output to Ground	0.5KVac

Sync DIN Rail Power Supply

24V 50W 1 Phase (NEC Class 2) / DRS-24V50W1N□

EMC

Emissions (CE & RE)		Generic Standards: EN 61000-6-3, EN 61000-6-4 CISPR 32, EN 55032 EN 55011, FCC Title 47: Class B	
Component Power Supply for General Use		EN 61204-3	
Immunity		Generic Standards: EN 55024, EN 61000-6-1, EN 61000-6-2	
Electrostatic Discharge	IEC 61000-4-2	Level 3 Criteria A ¹⁾ Air Discharge: 8kV Contact Discharge: 6kV	
Radiated Field	IEC 61000-4-3	Level 3 Criteria A ¹⁾ 80MHz-1GHz, 10V/M with 1kHz tone / 80% modulation 1.4GHz-2GHz, 3V/M with 1kHz tone / 80% modulation 2GHz-2.7GHz, 1V/M with 1kHz tone / 80% modulation	
Electrical Fast Transient / Burst	IEC 61000-4-4	Level 3 Criteria A ¹⁾ 2kV	
Surge	IEC 61000-4-5	Level 3 Criteria A ¹⁾ Common Mode ³⁾ : 2kV Differential Mode ⁴⁾ : 1kV	
Conducted	IEC 61000-4-6	Level 3 Criteria A ¹⁾ 150kHz-80MHz, 10Vrms	
Power Frequency Magnetic Fields	IEC 61000-4-8	Criteria A ¹⁾ 30A/Meter	
Voltage Dips and Interruptions	IEC 61000-4-11	0% of 100Vac, 20ms 0% of 100Vac, 5000ms 40% of 100Vac, 200ms 70% of 100Vac, 10ms 70% of 100Vac, 500ms 0% of 240Vac, 20ms 0% of 240Vac, 5000ms 40% of 240Vac, 200ms 70% of 240Vac, 500ms	Criteria A ¹⁾ Criteria B ²⁾ Criteria B ²⁾ Criteria A ¹⁾ Criteria B ²⁾ Criteria A ¹⁾ Criteria B ²⁾ Criteria A ¹⁾ Criteria A ¹⁾
Low Energy Pulse Test (Ring Wave)	IEC 61000-4-12	Level 3 Criteria A ¹⁾ Common Mode ³⁾ : 2kV Differential Mode ⁴⁾ : 1kV	
Harmonic Current Emission		IEC/EN 61000-3-2, Class A	
Voltage Fluctuation and Flicker		IEC/EN 61000-3-3	

1) Criteria A: Normal performance within the specification limits
 2) Criteria B: Temporary degradation or loss of function which is self-recoverable
 3) Asymmetrical: Common mode (Line to earth)
 4) Symmetrical: Differential mode (Line to line)



Sync DIN Rail Power Supply

24V 50W 1 Phase (NEC Class 2) / DRS-24V50W1N□

Block Diagram

DRS-24V50W1NZ

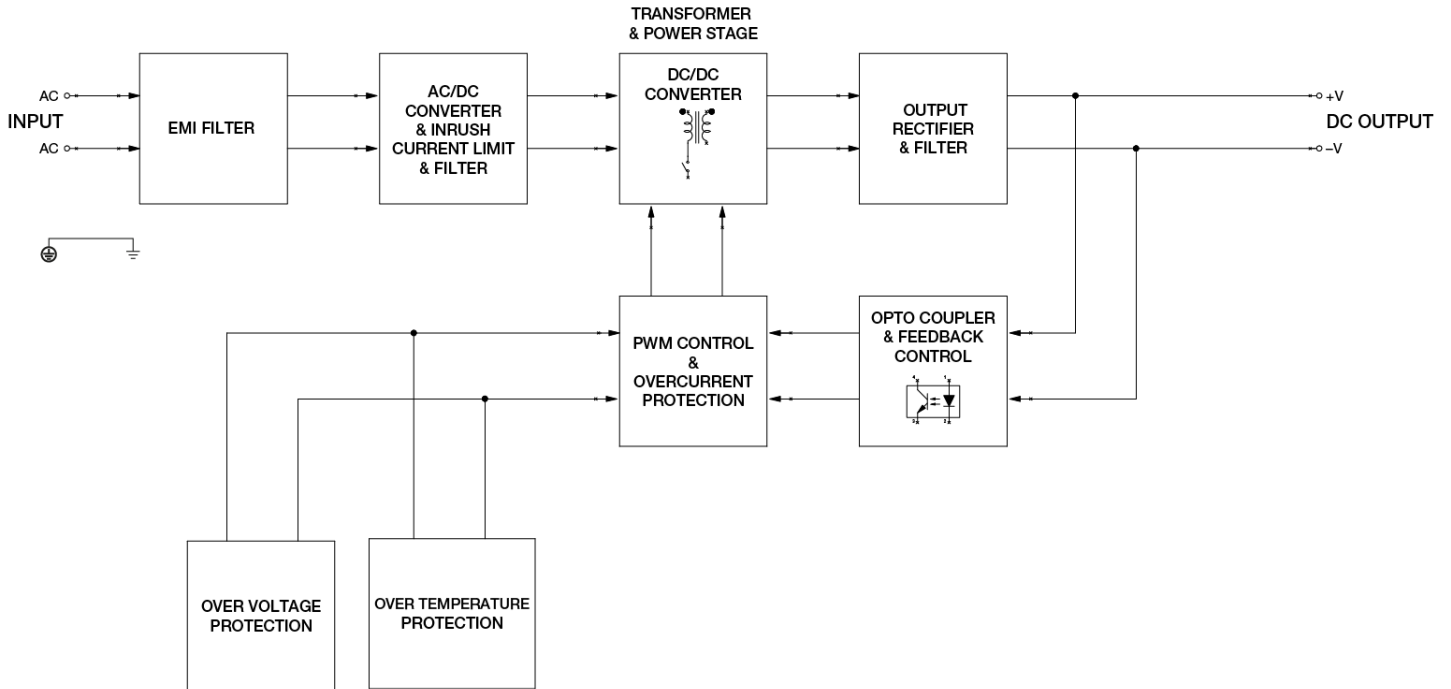

DRS-24V50W1NR

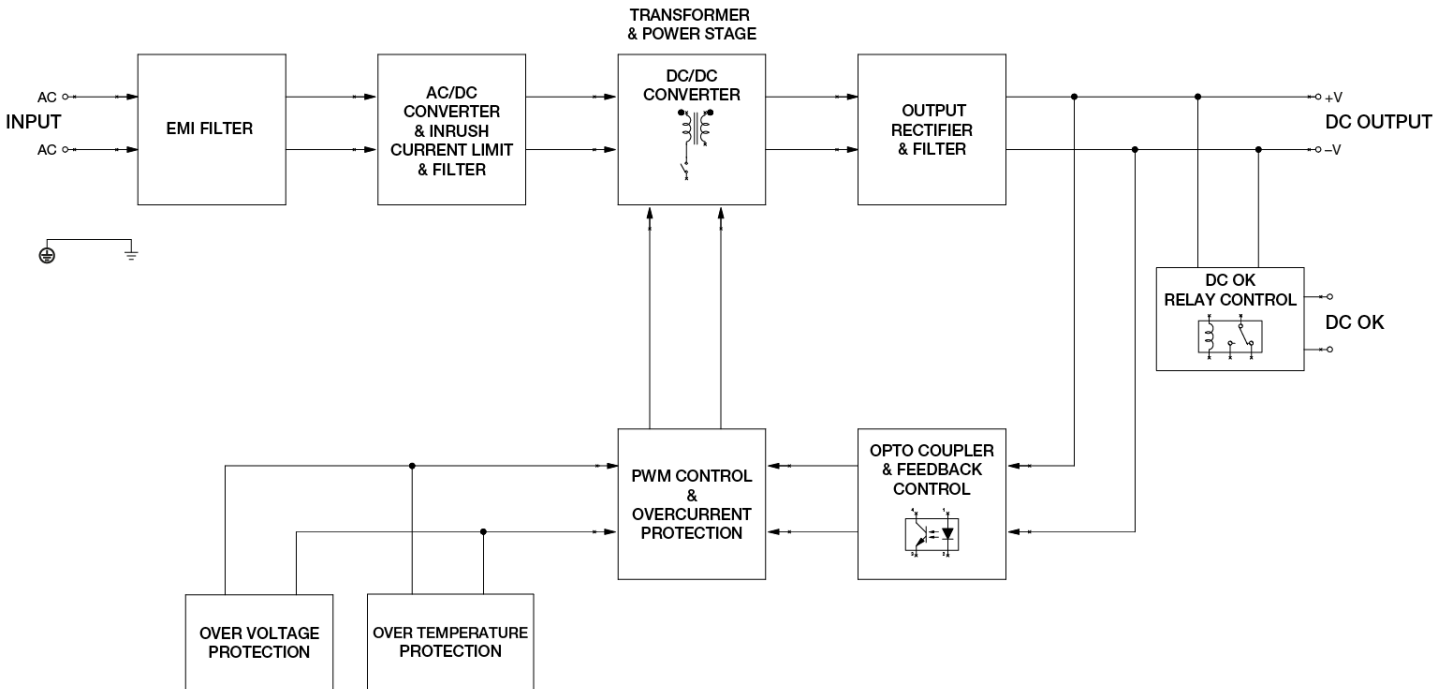

Sync DIN Rail Power Supply

24V 50W 1 Phase (NEC Class 2) / DRS-24V50W1N□

Device Description

DRS-24V50W1NZ

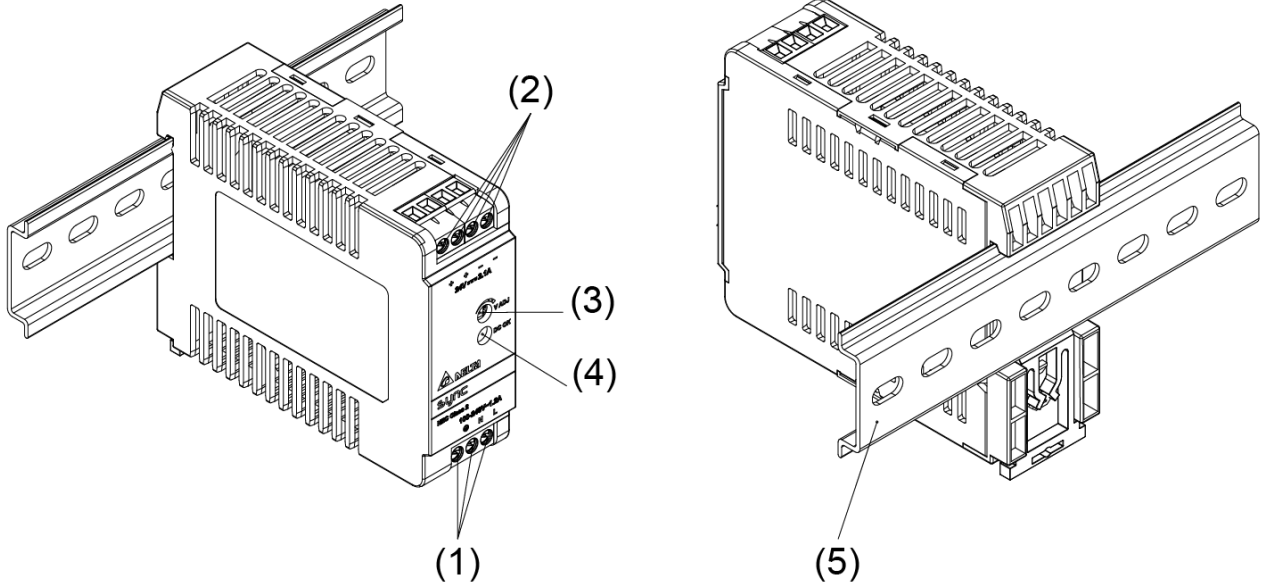

- 1) Input terminal block connector
- 2) Output terminal block connector
- 3) DC voltage adjustment potentiometer
- 4) DC OK LED (Green)
- 5) Universal mounting system

DRS-24V50W1NR

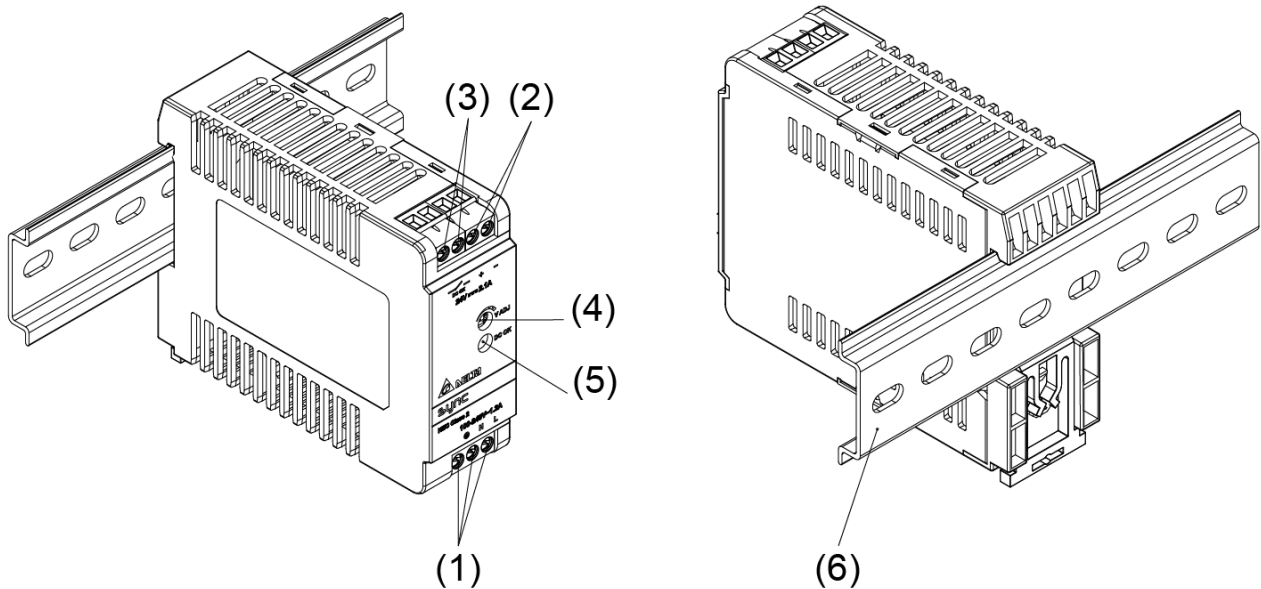

- 1) Input terminal block connector
- 2) Output terminal block connector
- 3) DC OK relay contact
- 4) DC voltage adjustment potentiometer
- 5) DC OK LED (Green)
- 6) Universal mounting system

Sync DIN Rail Power Supply

24V 50W 1 Phase (NEC Class 2) / DRS-24V50W1N□

Dimensions

■ **DRS-24V50W1NZ**

L x W x D: 75 x 30 x 89.5 mm [2.95 x 1.18 x 3.52 inch]

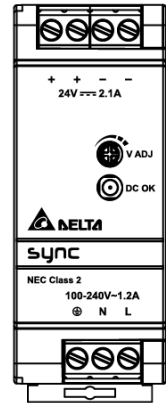
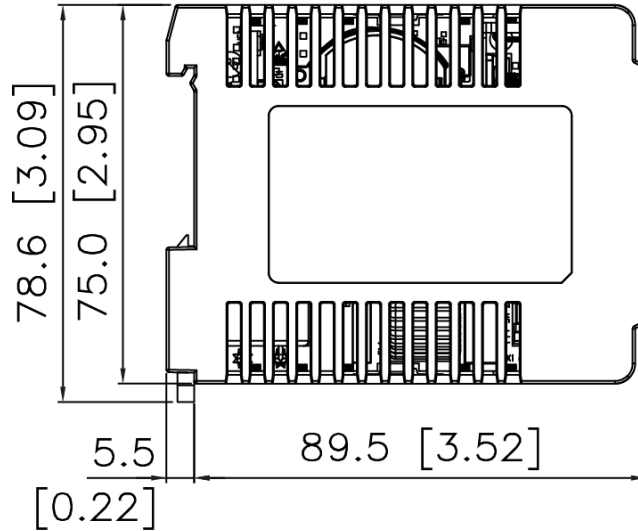
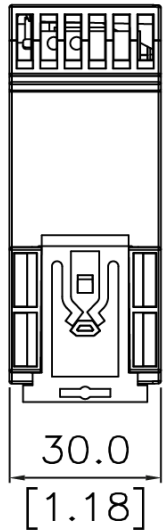

■ **DRS-24V50W1NR**

L x W x D: 75 x 30 x 89.5 mm [2.95 x 1.18 x 3.52 inch]

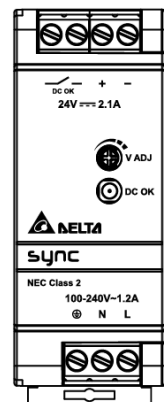
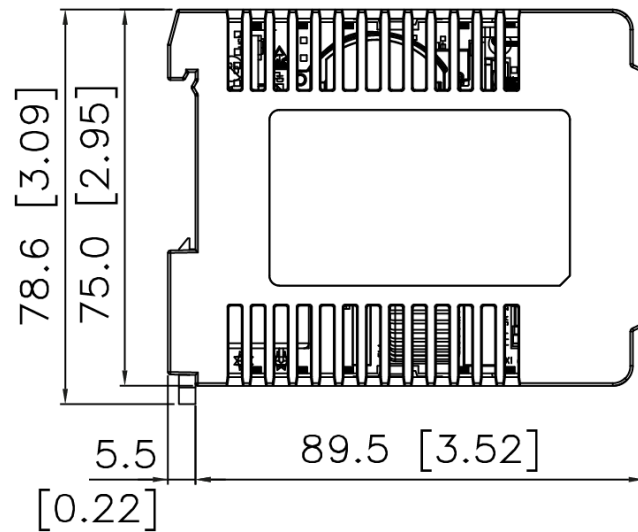
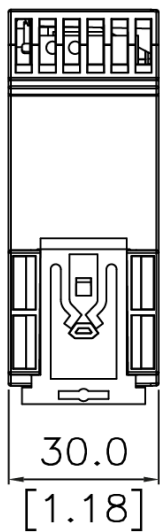

Sync DIN Rail Power Supply

24V 50W 1 Phase (NEC Class 2) / DRS-24V50W1N□

Engineering Data

Output Load De-rating VS Surrounding Air Temperature

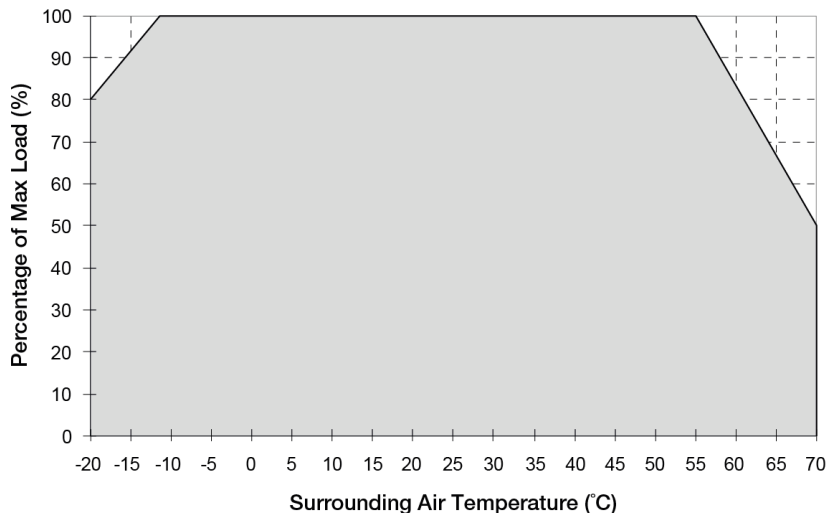

Fig. 1 De-rating for Vertical Mounting Orientation

-10°C to -20°C de-rate power by 2% / °C
 > 55°C de-rate power by 3.33% / °C

Note

1. Power supply components may degrade, or be damaged, when the power supply is continuously used outside the shaded region, refer to the graph shown in Fig. 1.
2. If the output capacity is not reduced when the surrounding air temperature >55°C, the device will run into Over Temperature Protection. When activated, power supply will latch off, until the surrounding air temperature is lowered or the load is reduced as far as necessary to keep the device in working condition, and require removal/re-application of input AC voltage in order to restart.
3. In order for the device to function in the manner intended, it is also necessary to keep a safety distance of 80mm (3.14 inch) above and below the device as well as a lateral distance of 25mm (0.98 inch) to other units while the device is in operation.
4. Depending on the surrounding air temperature and output load delivered by the power supply, the device can be very hot!
5. If the device has to be mounted in any other orientation, please contact info@deltapsu.com for more details.

Output Load De-rating VS Input Voltage

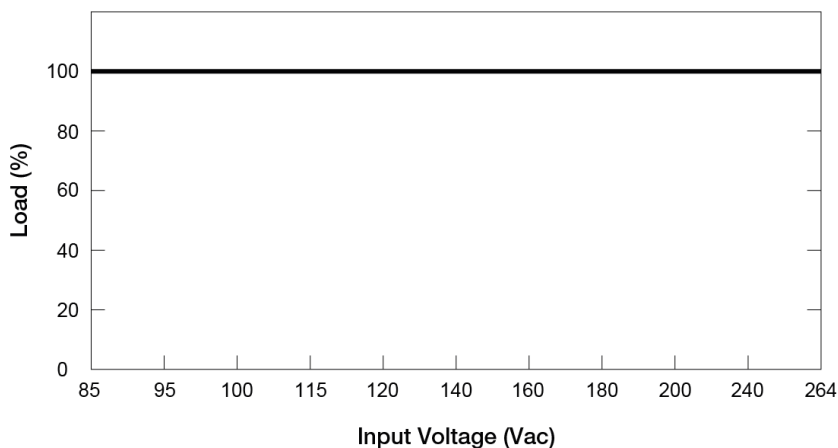

- No output power de-rating across the entire input voltage range

Sync DIN Rail Power Supply

24V 50W 1 Phase (NEC Class 2) / DRS-24V50W1N□

Assembly & Installation

The power supply unit (PSU) can be mounted on 35mm DIN rails in accordance with EN60715. The device should be installed with input terminal block at the bottom.

Each device is delivered ready to install.

Mounting

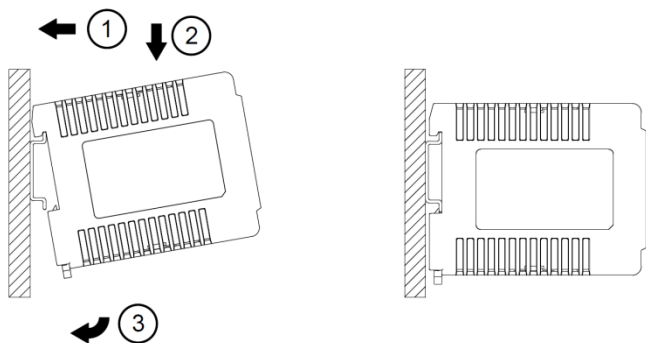

Fig. 2.1 Mounting

Snap on the DIN rail as shown in Fig. 2.1:

1. Tilt the unit slightly upwards and put it onto the DIN rail.
2. Push downwards until stopped.
3. Press against the bottom front side for locking.
4. Shake the unit slightly to ensure that it is secured.

Dismounting

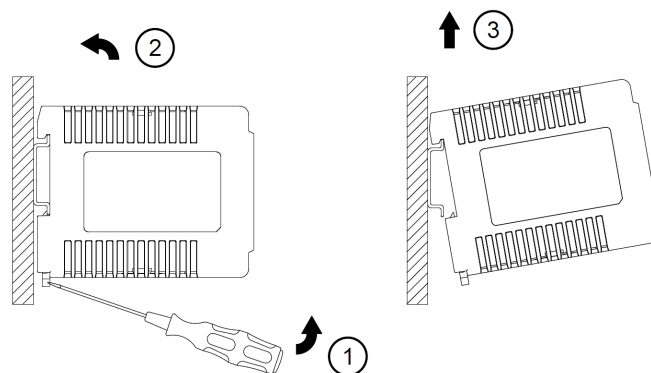
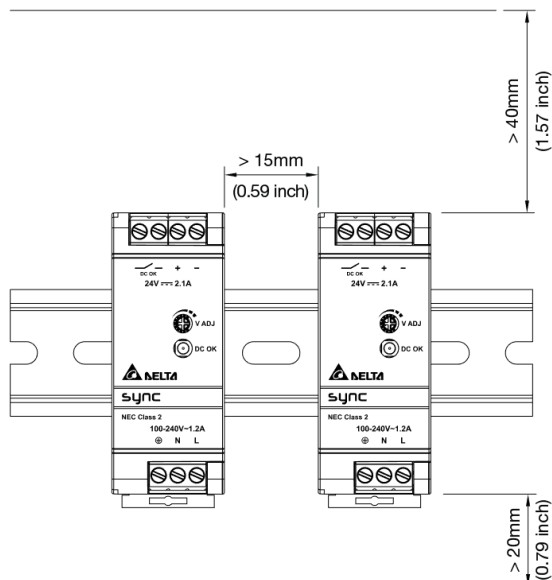

Fig. 2.2 Dismounting

To uninstall, pull or slide down the latch with screw driver as shown in Fig. 2.2. Then slide the power supply unit (PSU) in the opposite direction, release the latch and pull out the power supply unit (PSU) from the rail.

Safety Instructions



- ALWAYS switch mains of input power OFF before connecting and disconnecting the input voltage to the device. If mains are not turned OFF, there is risk of explosion / severe damage.
- To guarantee sufficient convection cooling, keep a distance of > 40mm (1.57 inch) above and > 20mm (0.79 inch) below the device as well as a lateral distance of > 15mm (0.59 inch) to other units. In case the adjacent device is a heat source, the lateral distance will be > 25mm (0.98 inch).
- Note that the enclosure of the device can become very hot depending on the surrounding air temperature and output load connected to the device. Risk of burns!
- The main power must be turned off before connecting or disconnecting the wires to the terminals!
- DO NOT insert any objects into the device.
- Dangerous voltages present for at least 5 minutes after disconnecting all sources of power.
- The power supplies unit should be installed in minimum IP54 rated enclosure.
- The power supplies are built in units and must be installed in a cabinet or room (condensation free environment and indoor location) that is relatively free of conductive contaminants.

Sync DIN Rail Power Supply

24V 50W 1 Phase (NEC Class 2) / DRS-24V50W1N□

Functions

- Graph illustrating the Start-up Time, Rise Time, and Hold-up Time

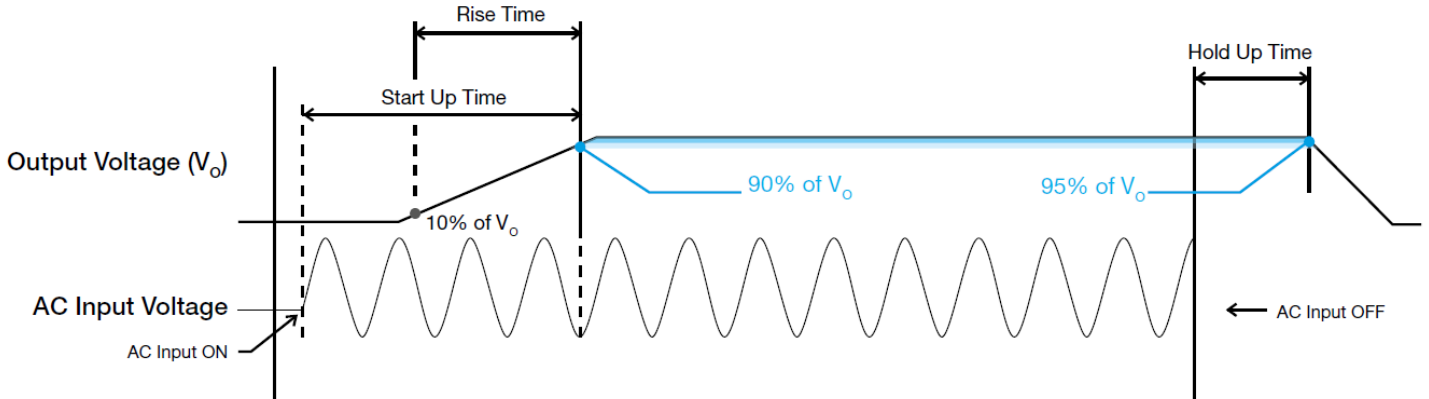

Start-up Time

The time required for the output voltage to reach 90% of its final steady state set value, after the input voltage is applied.

Rise Time

The time required for the output voltage to change from 10% to 90% of its final steady state set value.

Hold-up Time

Time between the collapse of the AC input voltage, and the output falling to 95% of its steady state set value.

Inrush Current

Inrush current is the peak, instantaneous, input current measured and, occurs when the input voltage is first applied. For AC input voltages, the maximum peak value of inrush current will occur during the first half cycle of the applied AC voltage. This peak value decreases exponentially during subsequent cycles of AC voltage.

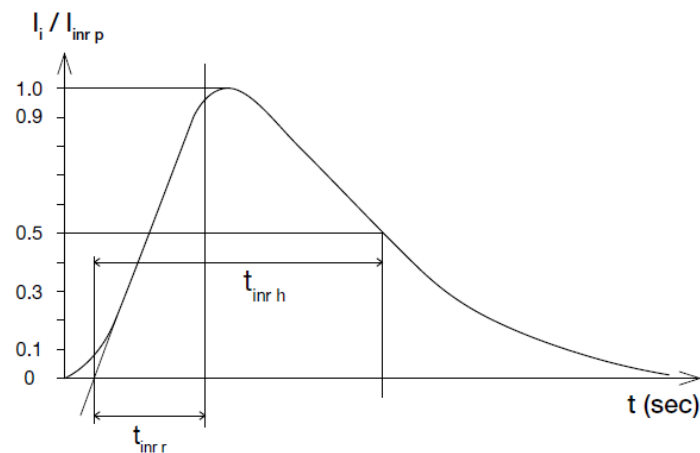

Dynamic Response

The power supply output voltage will remain within $\pm 5\%$ of its steady state value, when subjected to a dynamic load from 0% to 100% of its rated current.

- 50% duty cycle / 5Hz to 1KHz

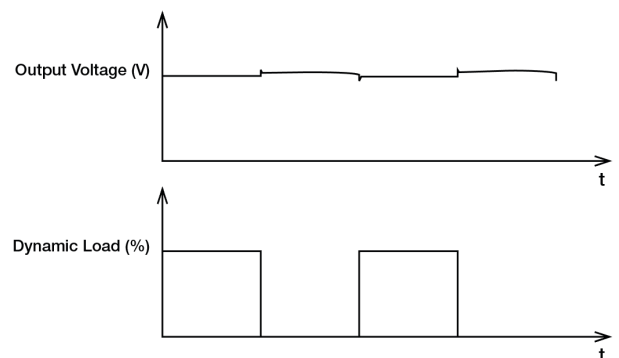

Sync DIN Rail Power Supply

24V 50W 1 Phase (NEC Class 2) / DRS-24V50W1N□

Overload & Overcurrent Protections (Auto-Recovery)

The power supply's Overload (OLP) and Overcurrent (OCP) Protections will be activated when output current is about 2.4A typ. When this occurs, the V_o will start to droop (refer to ① below). Once the output voltage is below about 14Vdc typ., the power supply will start to operate in "Hiccup mode" (Auto-Recovery mode). The power supply will recover once the fault condition of the OCP is removed and output current is back within the specifications.

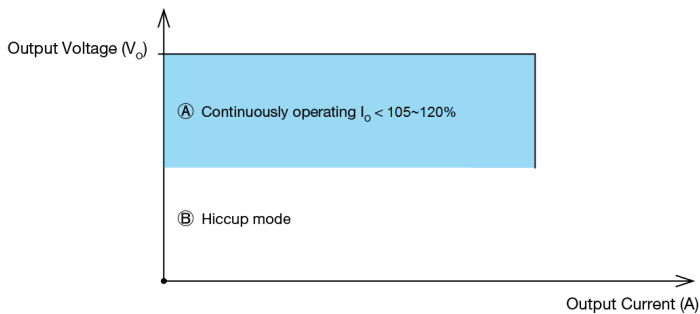

Short Circuit Protection (Auto-Recovery)

The power supply's output Short Circuit Protection function also provides protection against short circuits. When a short circuit is applied, the output current will operate in "Hiccup mode". The power supply will return to normal operation after the short circuit is removed.

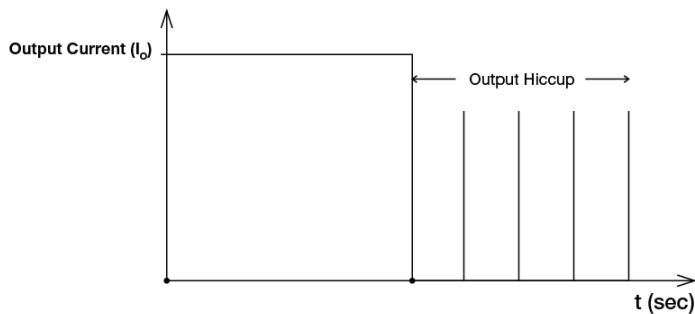

Overvoltage Protection (Latch Mode)

The power supply's overvoltage circuit will be activated when its internal feedback circuit fails. The output voltage shall not exceed its specifications defined on Page 3 under "Protections". Power supply will latch off, and require removal/re-application of input AC voltage in order to restart.

The power supply should be latch.

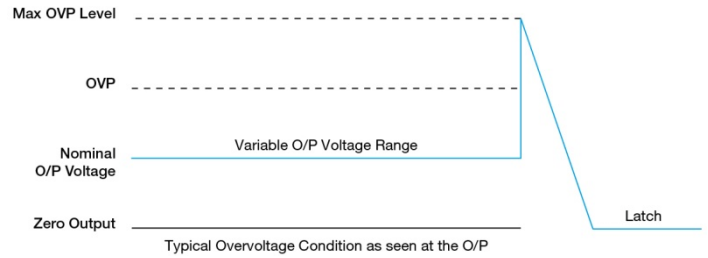

Over Temperature Protection (Latch Mode)

As described in load de-rating section, the power supply also has Over Temperature Protection (OTP). In the event of a higher operating temperature at 100% load; or, when the operating temperature is beyond what is recommended in the de-rating graph, the OTP circuit will be activated. When activated, power supply will latch off, until the surrounding air temperature drops to its normal operating temperature or the load is reduced as recommended in the de-rating graph. Removal/re-application of input AC voltage will then be required in order to restart.

External Input Protection Device

The unit is protected with internal fuse (not replaceable) at L pin and it has been tested and approved on 20A (UL) and 16A (IEC) branch circuits without additional protection device. An external protection device is only required if the supplying branch has an ampacity greater than above. Thus, if an external protective device is necessary, or, utilized, a minimum value of 20A B- or 13A C- characteristic breaker should be used.

Sync DIN Rail Power Supply

24V 50W 1 Phase (NEC Class 2) / DRS-24V50W1N□

Operating Mode

■ Redundant Operation

In order to ensure proper redundant operation for the power supply units (PSUs), the output voltage difference between the two units must be kept at 0.45~0.50V for these 24V supplies. Follow simple steps given below to set them up for the redundant operation:

Step 1.

Measure output voltage of PSU 1 and PSU 2. If PSU 1 is the master unit, then V_O of PSU 1 must be higher than PSU 2. In order to set the output voltage, individually connect each power supply to 50% of rated load at any line voltage from 85-264Vac, and set the PSU 1 and PSU 2 output voltage.

Step 2.

Connect the power supply units PSU 1 and PSU 2 to V_{in1} & V_{in2} , respectively, of the DRR-20N (or 20A) module shown on the right of above diagram.

Step 3.

Connect the system load to V_{out} . Please note that output voltage V_{out} from DRR module will be = V_O (output voltage of power supply) - V_{drop}^* (in DRR module).

* V_{drop} will vary from 0.60V to 0.90V (Typical 0.65V) depending on the load current and surrounding air temperature.

■ Parallel Operation

The power supply units (PSUs) can also be used for parallel operation in order to increase the output power. The difference in output voltage between the two units must be kept to within 25mV of each other. This difference must be verified with the same output load connected independently to each unit.

Parameters such as EMI, inrush current, leakage current, PARD, start up time will be different from those on the datasheet, when two units are connected in parallel. The user will need to verify that any differences will still allow the two power supplies connected in parallel will work properly in their product/application.

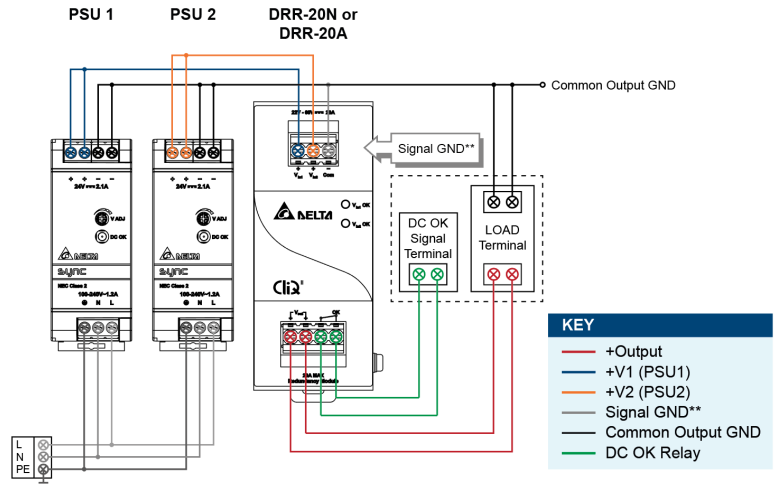

**The Signal GND in the DRR module is for the built-in LED and DC OK signals. The Output GND terminals from the two PSU's do not need to be connected to the Signal GND terminal.

Fig. 3 Redundant Operation Connection Diagram

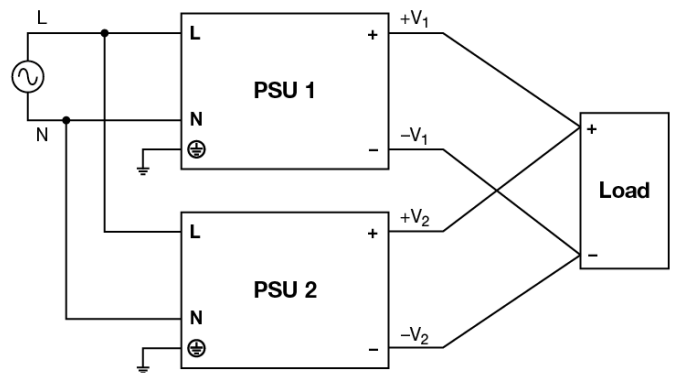

Fig. 4 Parallel Operation Connection Diagram

Sync DIN Rail Power Supply

24V 50W 1 Phase (NEC Class 2) / DRS-24V50W1N□

Others

Delta RoHS Compliant



Restriction of the usage of hazardous substances

The European directive 2011/65/EU limits the maximum impurity level of homogeneous materials such as lead, mercury, cadmium, chrome, polybrominated flame retardants PBB and PBDE for the use in electrical and electronic equipment. RoHS is the abbreviation for "Restriction of the use of certain hazardous substances in electrical and electronic equipment".

This product conforms to this standard.

Attention

Delta provides all information in the datasheets on an "AS IS" basis and does not offer any kind of warranty through the information for using the product. In the event of any discrepancy between the information in the catalog and datasheets, the datasheets shall prevail (please refer to www.DeltaPSU.com for the latest datasheets information). Delta shall have no liability of indemnification for any claim or action arising from any error for the provided information in the datasheets. Customer shall take its responsibility for evaluation of using the product before placing an order with Delta.

Delta reserves the right to make changes to the information described in the datasheets without notice.

X-ON Electronics

Largest Supplier of Electrical and Electronic Components

Click to view similar products for [DIN Rail Power Supplies](#) category:

Click to view products by [Delta](#) manufacturer:

Other Similar products are found below :

[PS-S6024](#) [DVP01PU-S](#) [DVP06AD-S](#) [DVP06XA-S](#) [DVDPNET-SL](#) [DVPDT01-S](#) [DVPPS01](#) [PS-6012](#) [PS9Z-5R1G](#) [PS-C24024](#)
[DVP08ST11N](#) [DVPACAB530](#) [DVPCOPM-SL](#) [DVPEN01-SL](#) [DVPPF01-S](#) [ADNB008-48-1PM-C](#) [ADNB017-24-1PM-C](#) [ADNB040-24-1PM-C](#) [ADNB034-12-1PM-C](#) [SS14011524](#) [PS-UPS40](#) [PSC-6024](#) [PSD-A60W12](#) [96PS-A120WDIN](#) [PSD-A60W48](#) [PSD-A40W12](#) [PSD-A40W24](#) [SMP21-L20-DC24V-5A](#) [PSD-A40W48](#) [S8T-DCBU-02](#) [PS-S4024](#) [NTPS-24-1.3](#) [ZI-20](#) [PST-96024](#) [S82YVSC4P](#) [PS-S4005](#) [PS-10024](#) [PS-S10024](#) [PS-C12024](#) [PSP-480S24](#) [PS-C48024](#) [PSC-2024](#) [PSC-4012](#) [PSC-4048](#) [PSC-9615](#) [PSC-15124](#) [PSC-15148](#) [PSC-24148](#) [PSC-48148](#) [TRIO-PS-2G/1AC/12DC/5/C2LP](#)