



FEATURES

Electrical

- Efficiency up to 92.5% @72Vin,15Vout
- 4242Vdc reinforced isolation
- Input transient voltage: 14.4V/1S, 200V/1S
- Operating Baseplate Temperature Range: -40°C to +100°C
- Fully protected: Input UVLO, Output OVP & OCP and OTP
- Monotonic startup and pre-biased startup
- No minimum load requirement
- Meet EN50155 with external components
- Working altitude up to 5000 m

Mechanical

- Size: 63.1mm*60.6mm*13mm

Safety & Reliability

- IEC/EN/UL/CSA 62368-1
- IEC/EN/UL/CSA 60950-1
- Fire & Smoke meet EN45545-2
- Shock & Vibration meet EN50155(EN61373)
- ISO 9001, TL 9000, ISO 14001, QS 9000,
- OHSAS18001 certified manufacturing facility

Input voltage: 16.8~137.5V continuous
14.4~200V transient
Single output: 12V, 15V, 24V, 48V, 54V
Output power: 100W

Recommended part number

Model Name	rated Input	Output		Eff. @ 100% Load	Others
H80SV12008PRFS	16.8~137.5 continuous 14.4~200V transient	12V	8.5A	89.0% @72V	Positive on/off Threaded mounting hole
H80SV15007PRFS		15V	7.0A	92.5% @72V	
H80SV24004PRFS		24V	4.2A	88% @72V	
H80SV48002PRFS		48V	2.1A	90% @72V	
H80SV54002PRFS		54V	1.9A	90% @72V	

Part numbering system

H	80	S	V	xxxxx	P	R	F	S
Form Factor	Input Voltage	Number Of Outputs	Product Series	Output Voltage & Current	ON/OFF Logic	Pin Length	Option Code	Option Code
H - 1/2 Brick	80 - 16.8~137.5V	S - Single	V - Series Number	12008 - 12V & 8.5A 15007 - 15V & 7.0A 24004 - 24V & 4.2A 48002 - 48V & 2.1A 54002 - 54V & 1.9A	P - Positive N - Negative	R - 0.170"	F - RoHS 6/6 (Lead Free)	A - unthreaded mounting hole S - with threaded mounting hole(M3*0.5)

TECHNICAL SPECIFICATION

All specifications valid at 72Vin, 100% Rated load and 25°C ambient, unless otherwise indicated.

Attribute		Model	H80SV12008	H80SV15007	H80SV24004	H80SV48002	H80SV54002
INPUT	Voltage	continuous	16.8~137.5Vdc				
		transient	14.4V/1S, 200V/1S				
	Current	@ 16.8Vin, full load	7.5A max				
		@ 72Vin, No load	60mA(30~90mA)				
		@ Enable off & 72V	30mA max				
Efficiency	72Vin, 100% load	89%	92.5%	88%	90%	90%	
	72Vin, 60% load	87%	91%	89%	88%	89%	
OUTPUT	Voltage Setting(72Vin, no load, 25°C)		12V±1%	15V±1%	24±1%	48±1%	54±1%
	Current Rating		0~8.5A	0~7.0A	0~4.2A	0~2.1A	0~1.9A
	Voltage trim range *1		-20%~+10%				
	Ripple & Noise(Vp-p) *2		30mV	35mV	35mV	80mV	200mV
	Output Sense Range		10%	10%	5%	4%	4%
	Output Regulation	Line (full load)	0.2% Max				
		Load (72Vin)	0.2% Max				
		Temperature(72Vin)	0.007%/°C				
	Start-up Time *3	Delay from input	200~460ms				
		Delay from on/off	200~460ms				
		Rise time	Max 100ms				
Transient response *4	Voltage deviation	280mV	280mV	400mV	400mV	750mV	
Output capacitance		Max 2200uF	Max 1000uF	Max 1000uF	Max 100uF	Max 100uF	
PROTECTION	Output Over Current (hiccup)		10~24A	8.5~19A	5.0~12.0A	2.5~7.0A	2.2~6.5A
	Output Over Voltage (hiccup)		13.2~15.6V	16.5~19V	26.4~31.2V	52.8~62.4V	59.4~70.2V
	Input UVLO	On threshold	16.0V(15.2~16.4V)				
		Off threshold	14.0V(13.2~14.6V)				
		Hysteresis	2V				
OTP shutdown	Shutdown NTC	125°C					
	Restart Hysteresis	6°C					
ISOLATION	Voltage, Input to Output						
	Voltage, Input to baseplate		4242Vdc				
	Voltage, Output to baseplate						
	Resistance (at 500Vdc)		100 MΩ min				
ENVIRONMENT	Operating ambient temperature		-40~85°C				
	Operating baseplate temperature		-40~100°C				
	Storage temperature		-40~125°C				
	Operating Humidity		Max 95%				
ENABLE CONTROL	Logic low		0~0.4V				
	Logic high		3~5V				
	Current (Von/off=0V)		1.5mA max				
Others	Fixed Switching Frequency		140kHz				
	MTBF(72Vin, 80% load, 25°C)		1.48 Mhours				
	Weight		125g				

Notes

*1 Maximum output power & current of the module should not over rated output power & current.

*2 Ripple & Noise measurement bandwidth is 0-20MHz, $V_{in}=72V$, full load, $C_{out}=10\mu F$ tan (24V/48V/54V output need use polymer)+1 μF ceramic

*3 **“Delay from input”**: from V_{in} reaching turn-on threshold to 10% V_{out} (pre-applied enable); **“Delay from on/off”**: From enable to 10% V_{out} (pre-applied V_{in}); **“Rise time”** From 10% to 90% V_{out} .

*4 Load transient test condition: 72V $_{in}$, 50% to 75% full load, 10 μF Tan (24V/48V/54V output need use polymer) & 1 μF ceramic load cap, 0.1A/us.

Mechanical Drawing

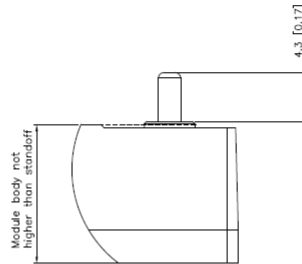
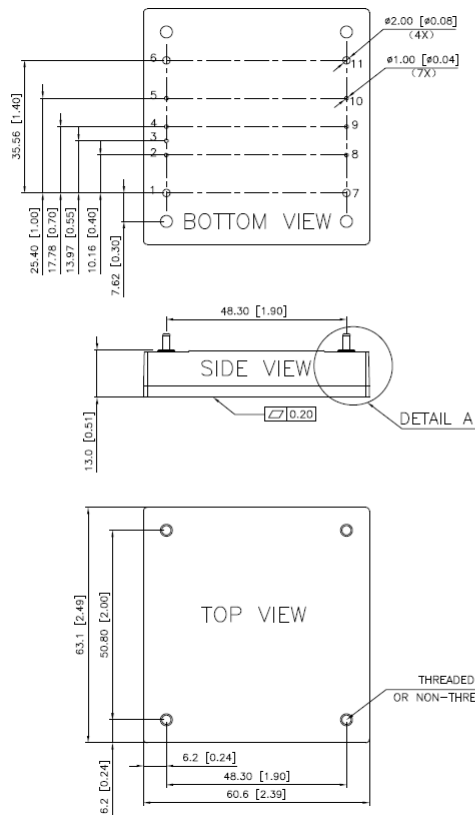

DETAIL A
SCALE 3:1

PIN #	FUNCTION
1	Vin+
2	UVLO
3	PULSE OUT
4	ON/OFF
5	BUS
6	Vin-
7	Vout+
8	Sense+
9	Trim
10	Sense-
11	Vout-

All dimensions in mm (inches)
Tolerance: X.X \pm 0.5 (X.XX \pm 0.02)
X.XX \pm 0.25 (X.XXX \pm 0.010)

Pin definition

PIN	NAME	DESCRIPTION
1	Vin+	the positive input pin
2	UVLO	by pulled up/down through resistor, this pin allows to tune the UVLO level
3	PULSE OUT	output 1kHz/50% pulse voltage, easy to realize inrush limited circuit
4	ON/OFF	Remote on/off pin
5	BUS	200uF cap and 3ohm Resistor connected between BUS and VIN- is necessary to keep operating stable, and also realize 0~30ms hold up time with a optional RCD circuit
6	VIN-	the negative input pin
7	VOUT+	the positive output
8	SENSE+	the positive sense pin
9	TRIM	by pulled up/down through resistor, this pin allow to tune output voltage up/down.
10	SENSE-	the negative sense pin
11	VOUT-	the negative output

Recommended layout

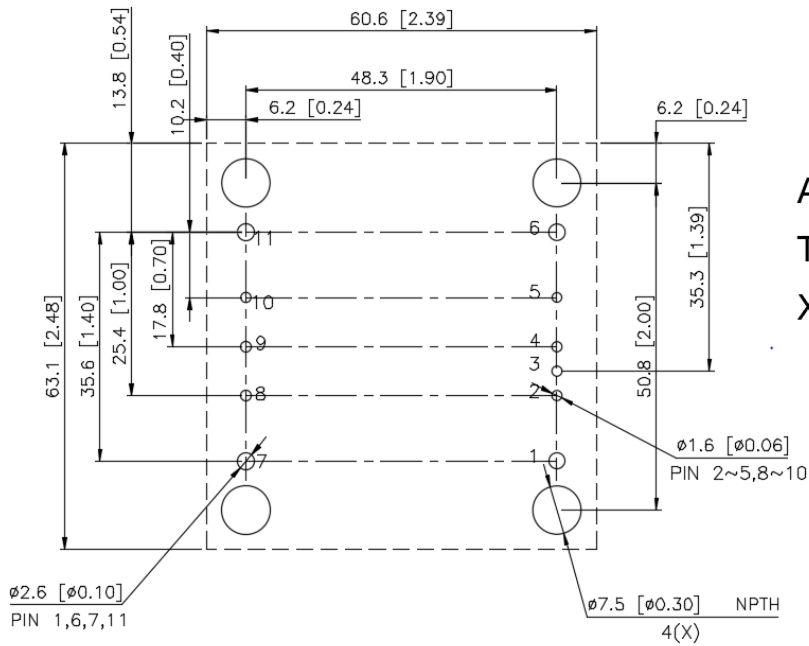

All dimensions in mm (inches)
 Tolerance: $X.X \pm 0.5$ ($X.XX \pm 0.02$)
 $X.XX \pm 0.25$ ($X.XXX \pm 0.010$)

PIN #	FUNCTION	D_pin	PIN #	FUNCTION	D_pin
1	Vin+	$\phi 2.00$	7	Vout+	$\phi 2.00$
2	UVLO	$\phi 1.00$	8	Sense+	$\phi 1.00$
3	PULSE OUT	$\phi 1.00$	9	Trim	$\phi 1.00$
4	ON/OFF	$\phi 1.00$	10	Sense-	$\phi 1.00$
5	BUS	$\phi 1.00$	11	Vout-	$\phi 2.00$
6	Vin-	$\phi 2.00$			

Input filter design to comply with EN50155

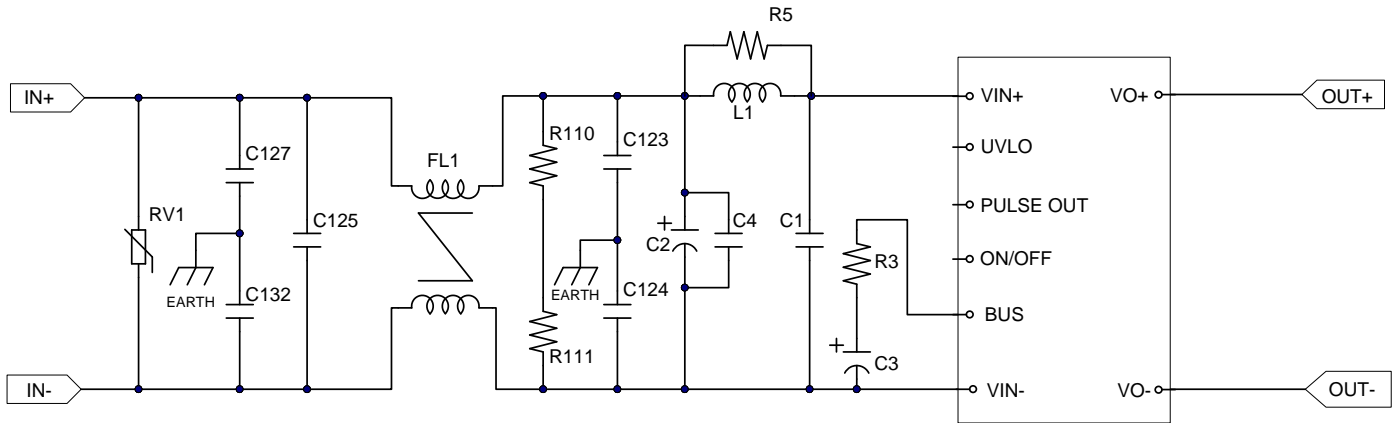

***Note:** Refer to page11 for the UVLO(pin2), PULSE OUT(pin3) and ON/OFF(pin4) implementation.

ID	PART NO.	TYPE	PARAMETERS	QTY	VENDOR	Purpose
RV1 (MOV)	B72207S0131K101	Varistor	170VDC,1.2KA	1	EPCOS	For surge
C123,C124,C127,C132	R413F1100JU00M	Capacitor,Y2/X1	1000p,300VAC	4	KEMET	For EMC
C125	R46KF310045M1M	Capacitor,X2	0.1uF,275VAC	1	KEMET	
FL1	PH9455.105NL	Common choke	1mH	1	Pulse	
R110,R111	RV1206FR-07100K	1206 1/4W	100k ohm	2	YAGEO	For stable operation
C1	C1210X474K251TX	MLCC	0.47uF/250V(2pcs parallel)	2	HOLY STONE	
C4	C1210X474K251TX	MLCC	0.47uF/250V(2pcs parallel)	2	HOLY STONE	
C2	EKXG201ELL101ML20S	Capacitor, Electrolytic	100uF,200V	1	NCC	
C3	EKXJ251EC3121ML25S		120uF,250V(2pcs parallel)	2	NCC	
R3,R5	WF25S3R0JTL	Resistor	3ohm/J/1W 2512/surge type	1	WASIN	
L1	CMLS104T-3R3MS	choke	3.3uH	1	Cyntec	

*The components for EMC, surge and hold up time purpose can be deleted if don't need the function.

1. H80SV12008(12V output)

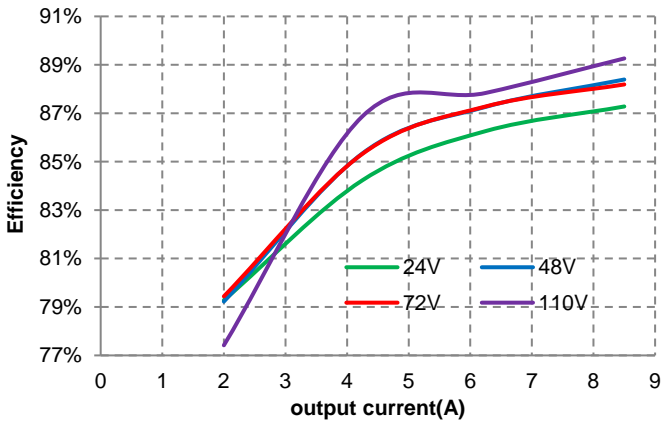

Figure 1: Efficiency vs. load current at 25°C.

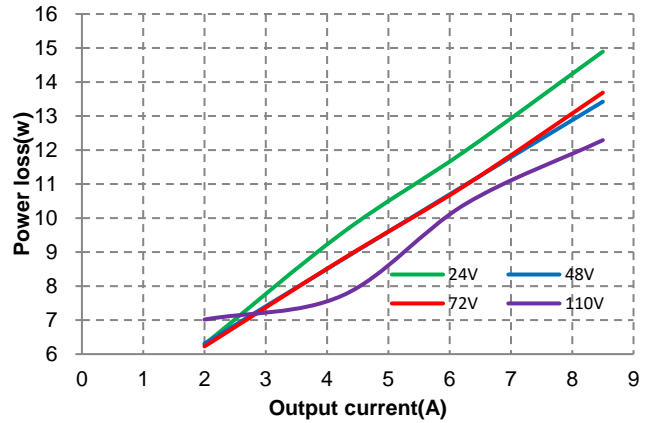

Figure 2: Power loss vs. load current at 25°C.

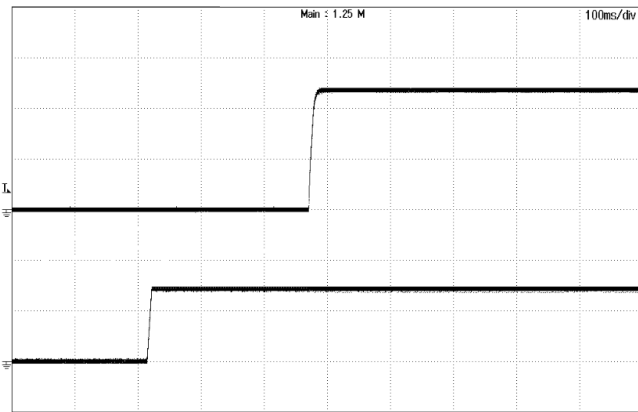

Figure 3: Turn-on transient at full load current (200ms/div). Top Trace: Vout, 5V/div; Bottom Trace: Vin, 50V/div

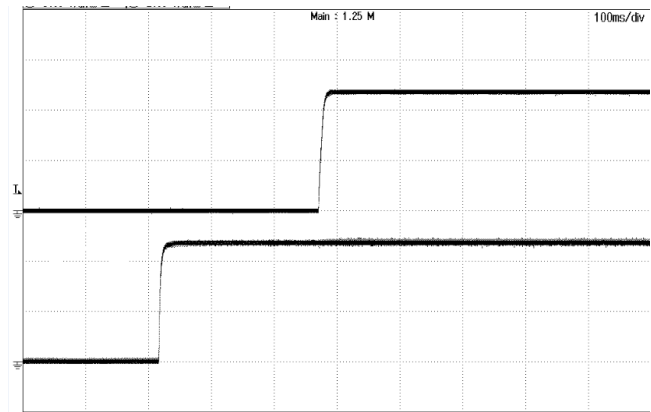

Figure 4: Turn-on transient at full load current (200ms/div). Top Trace: Vout, 5V/div; Bottom Trace: ON/OFF, 5V/div

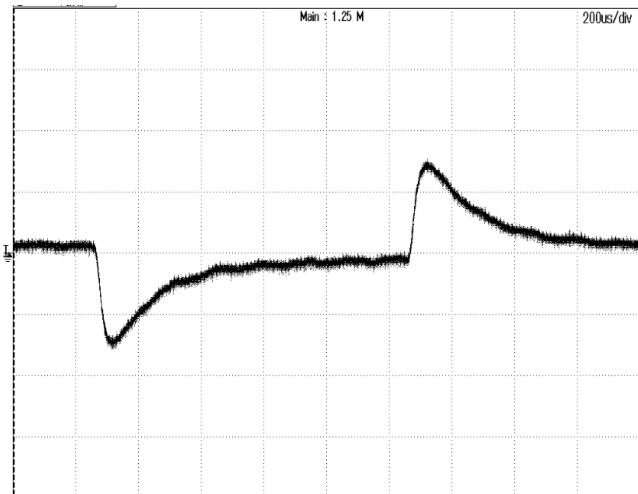

Figure 5: Output voltage response to step-change in load current (50%-75%-50% of full load; $di/dt = 0.1A/\mu s$). Trace: Vout: 200mV/div; Time: 200us/div

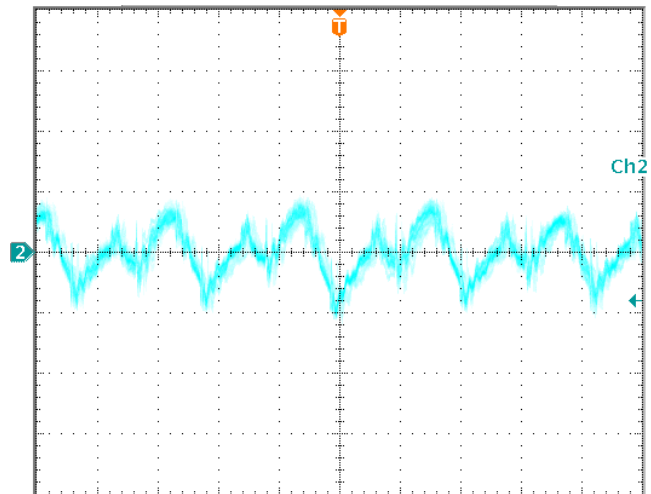

Figure 6: Output voltage ripple at $V_{in}=72V$ and full load Trace: Vout: 20 mV/div, 2us/div; Bandwidth: 20 MHz.

2. H80SV15007 (15V output)

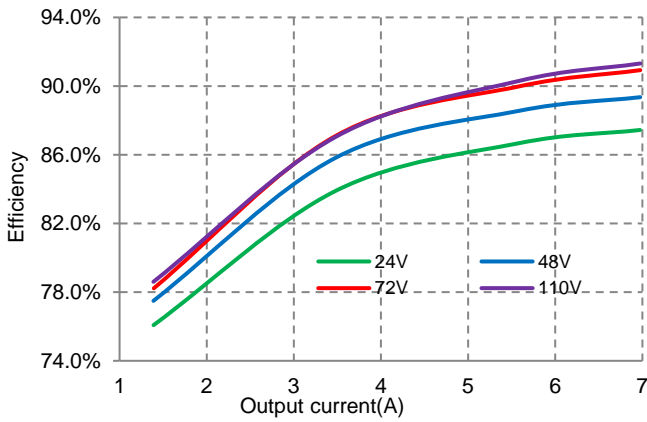

Figure 1: Efficiency vs. load current at 25°C.

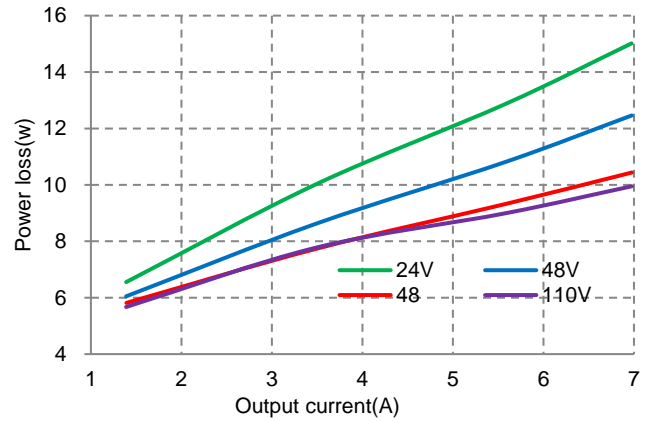

Figure 2: Power loss vs. load current at 25°C.

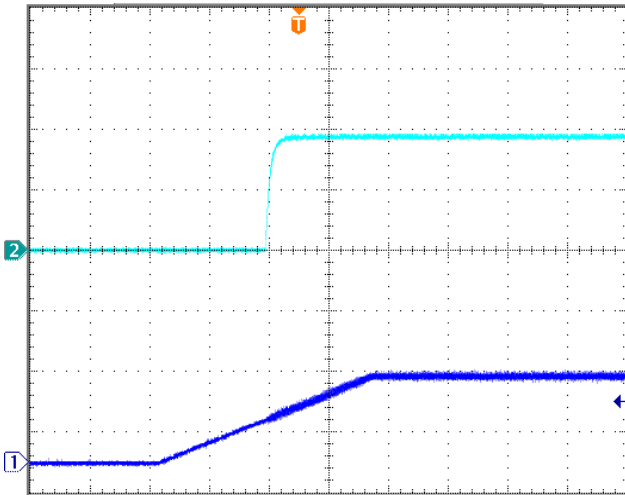

Figure 3: Turn-on transient at full load current (200ms/div). Top Trace: Vout, 8V/div; Bottom Trace: Vin, 50V/div

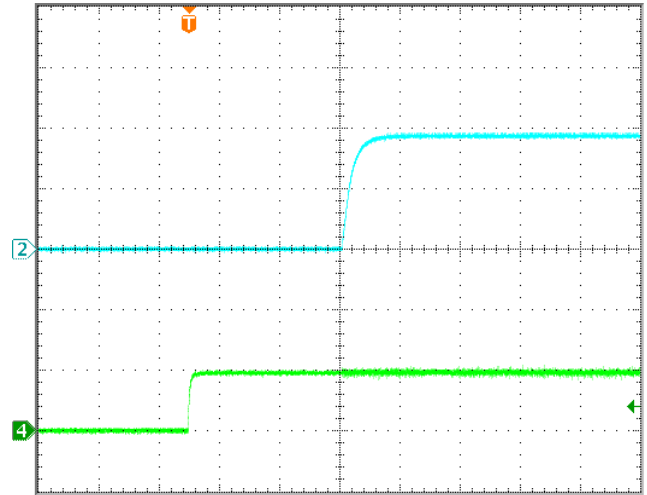

Figure 4: Turn-on transient at full load current (100ms/div). Top Trace: Vout, 8V/div; Bottom Trace: ON/OFF, 5V/div

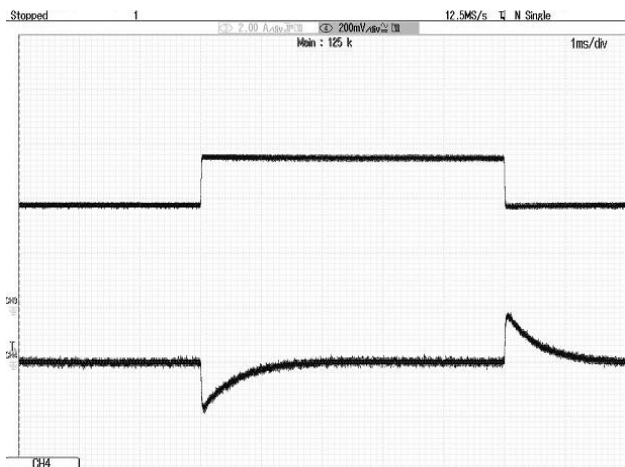

Figure 5: Output voltage response to step-change in load current (50%-75%-50% of full load; $di/dt = 0.1A/\mu s$). Top Trace: Iout, 5A/div; Bottom Trace: Vout, 200mV/div

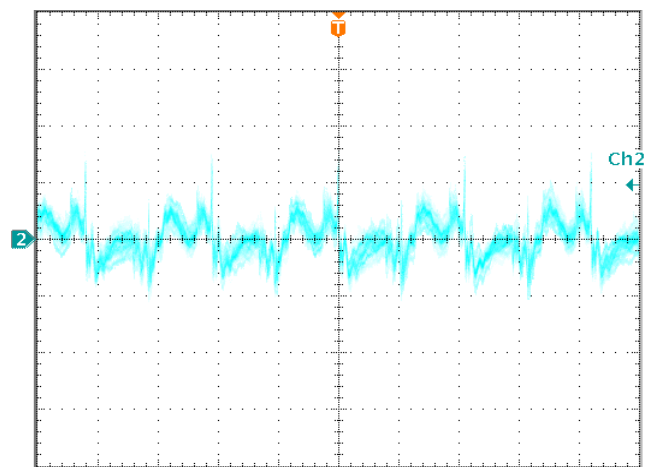

Figure 6: Output voltage ripple at $V_{in}=72V$ and full load. Trace: Vout: 10 mV/div, 2us/div; Bandwidth: 20 MHz.

3. H80SV24004 (24V output)

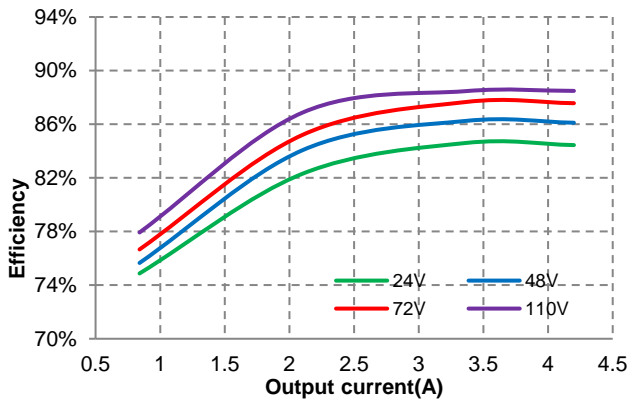

Figure 1: Efficiency vs. load current at 25°C.

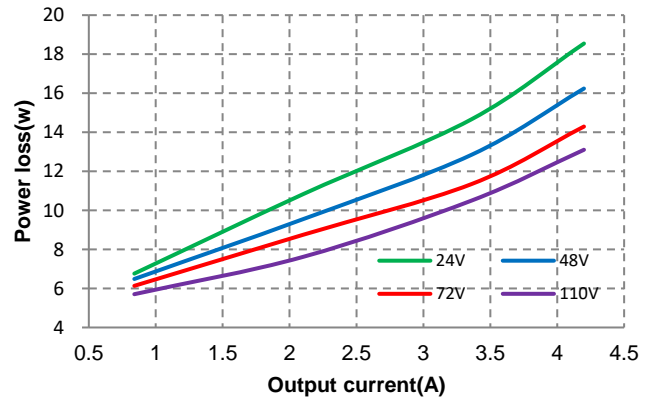

Figure 2: Power loss vs. load current at 25°C.

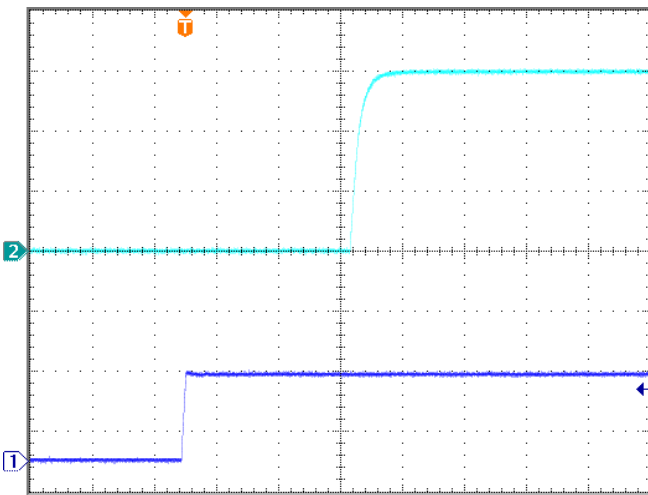

Figure 3: Turn-on transient at full load current (200ms/div). Top Trace: Vout, 8V/div; Bottom Trace: Vin, 50V/div

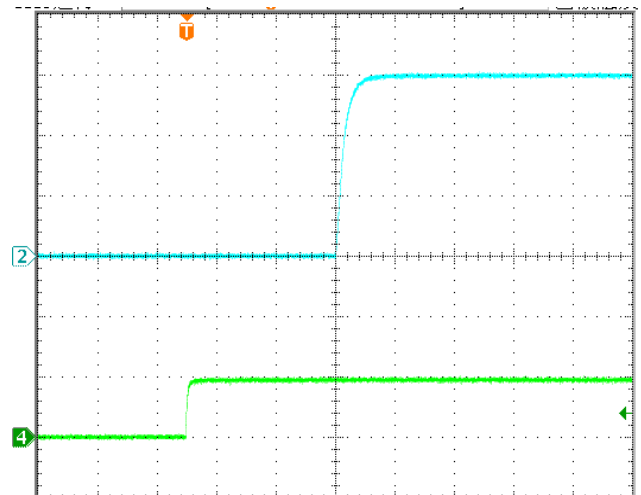

Figure 4: Turn-on transient at full load current (100ms/div). Top Trace: Vout, 8V/div; Bottom Trace: ON/OFF, 5V/div

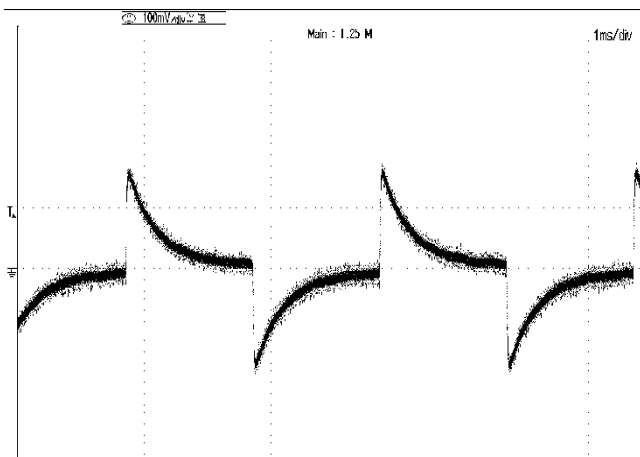

Figure 5: Output voltage response to step-change in load current (50%-75%-50% of full load; $di/dt = 0.1A/\mu s$). Trace: Vout; 100mV/div; Time: 1ms/div

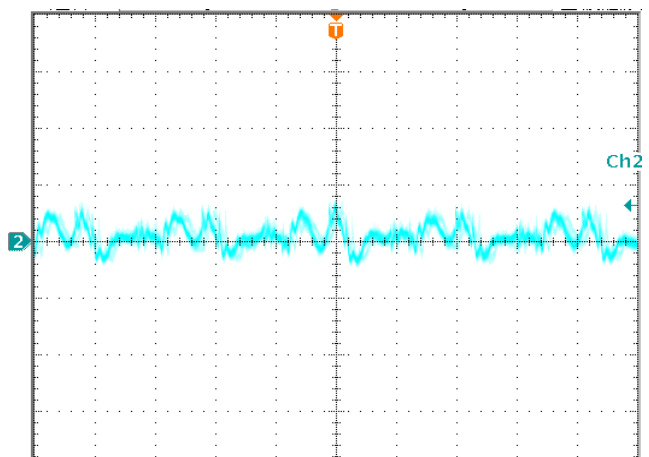

Figure 6: Output voltage ripple at $V_{in}=72V$ and full load. Trace: Vout; 10 mV/div, 2 μs /div; Bandwidth: 20 MHz.

4. H80SV48002 (48V output)

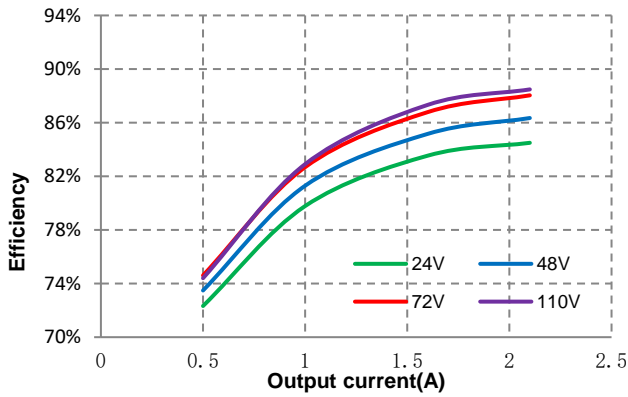

Figure 1: Efficiency vs. load current at 25°C.

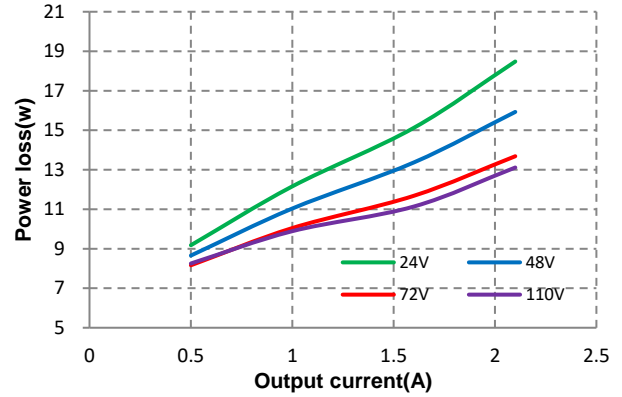

Figure 2: Power loss vs. load current at 25°C

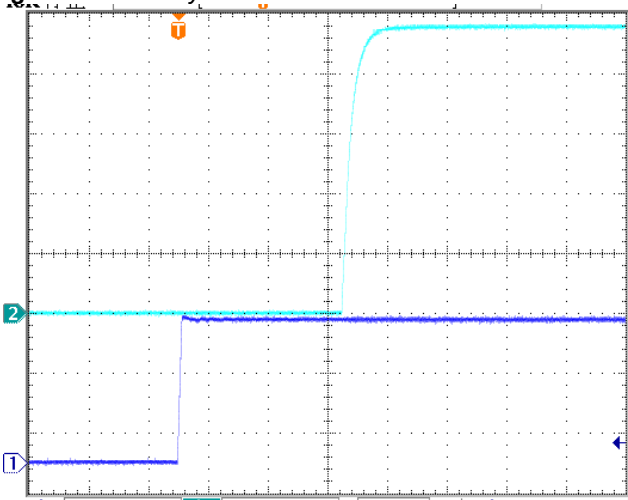

Figure 3: Turn-on transient at full load current (10ms/div).
Top Trace: Vout; 10V/div; Bottom Trace: Vin; 30V/div

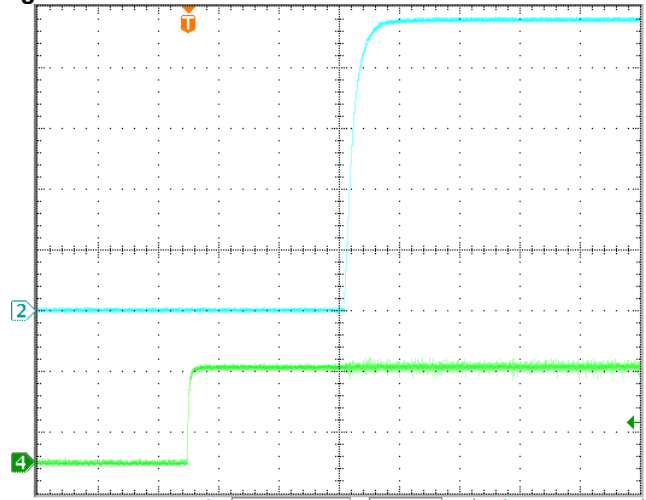

Figure 4: Turn-on transient at full load current (100ms/div).
Top Trace: Vout; 10V/div; Bottom Trace: ON/OFF; 3V/div



Figure 5: Output voltage response to step-change in load current (50%-75%-50% of full load; $di/dt = 0.1A/\mu s$).
Trace: Vout; 500mV/div; Time: 2ms/div

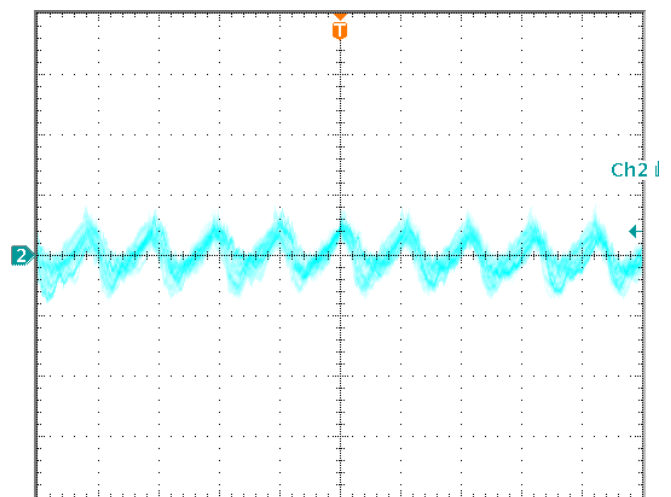

Figure 6: Output voltage ripple at $V_{in}=72V$ and full load
Trace: Vout; 25 mV/div, 2μs/div; Bandwidth: 20 MHz.

5. H80SV54002 (54V output)

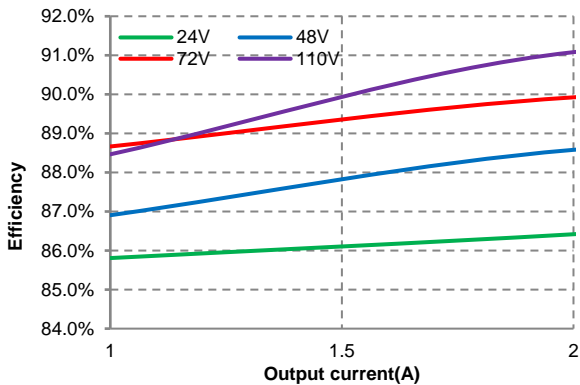

Figure 1: Efficiency vs. load current at 25°C.

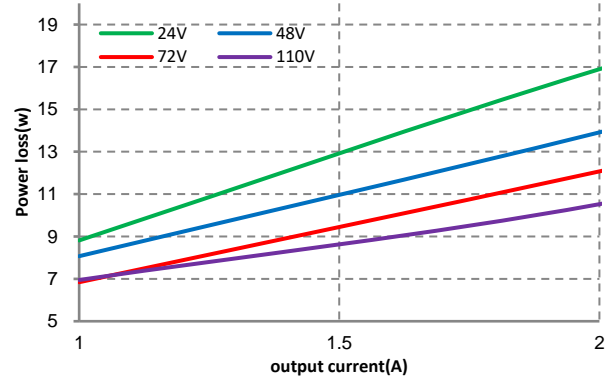

Figure 2: Power loss vs. load current at 25°C

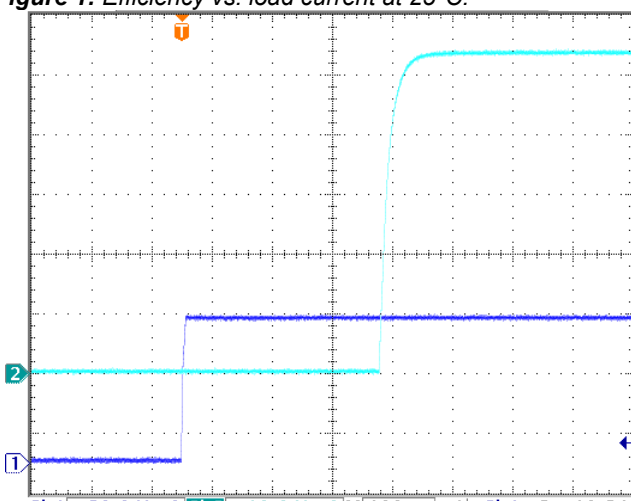

Figure 3: Turn-on transient at full load current (10ms/div).
Top Trace: Vout: 10V/div; Bottom Trace: Vin: 30V/div



Figure 5: Output voltage response to step-change in load current (50%-75%-50% of full load; $di/dt = 0.1A/\mu s$). Top Trace: Iout: 1A/div; Bottom Trace: Vout: 500mV/div

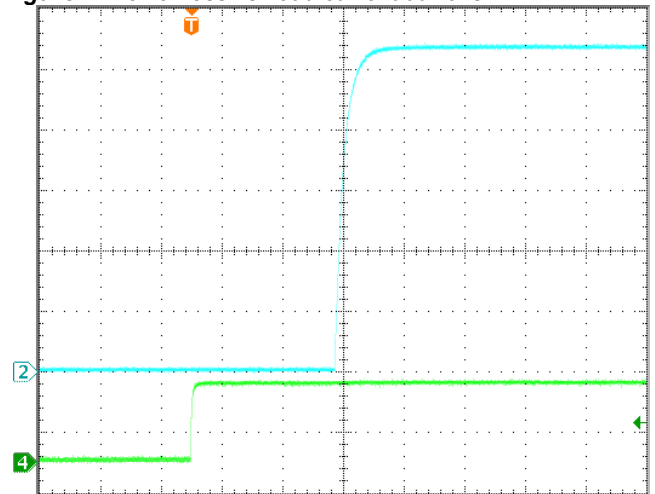

Figure 4: Turn-on transient at full load current (100ms/div).
Top Trace: Vout: 10V/div; Bottom Trace: ON/OFF: 3V/div

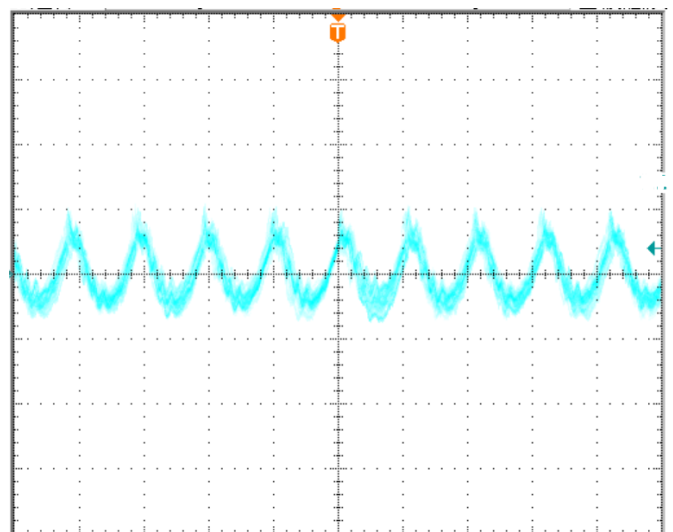

Figure 6: Output voltage ripple at $V_{in}=72V$ and full load
Trace: Vout: 25 mV/div, 2 μs /div; Bandwidth: 20 MHz.

Feature description

Over-Current Protection

The modules include both internal output over-current limit circuit, and over-current protection. The OCP level is higher than OCL level.

When load current exceed OCL level, the modules will decrease output voltage to limit load current. Once output voltage lower than 60% output set point, module will shut down and enter hiccup mode.

When load current rise fast and exceeds OCP level, the module will shut down quickly and enter hiccup mode, until the fault condition is removed. For H80SV48002 production, if output resistance is very low, the output current could be very high and cause damage. The module will be effectively protected only if load resistance higher than 2ohm.

Over-Voltage Protection

The modules include an internal output over-voltage protection circuit, which monitors the voltage on the output terminals. If this voltage exceeds the over-voltage set point, the module will shut down, and always try to restart until the over current condition is corrected

Over-Temperature Protection

The over-temperature protection consists of circuitry that provides protection from thermal damage. If the over-temperature is detected the module will shut down, and restart after the temperature is within specification.

UVLO (pin2)

Pin2 is for adjust turn on/off threshold voltage between Vin+ and Vin-, the default setting (leave the UVLO pin floating) is 16V on and 14V off. It also can be configured by a resistor connected between the UVLO and VIN (+/-) pin. The following table and figure show a typical configuration.

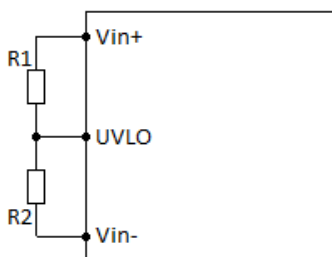

Figure7 UVLO pin Implementation

Nominal Vin	24V		36V	48V	72V	96V	110V
Turn-off Threshold	12 ±0.4V	14 ±0.4V	21.2 ±0.4V	28.4 ±0.4V	42.8 ±1V	57.2 ±1V	65.6 ±2V
Turn-on Threshold	14 ±0.4V	16 ±0.4V	24.5 ±0.4V	33.6 ±0.4V	50.4 ±1V	67.6 ±1V	76.8 ±2V
External Resistor (KΩ)*	2.2Meg	open	24.9	12.4	6.19	4.12	3.48
Location	R1 (leave R2=NC)		R2 (leave R1=NC)				

PULSE OUT(Pin3)

This pin outputs a 1KHz 50% duty cycle pulse voltage with 12V amplitude. It is designed to provide a bootstrap signal for the input inrush current limit circuit (as show in following figure), and also could indicate operating status with a LED connected. If this feature is not used, please left it open.

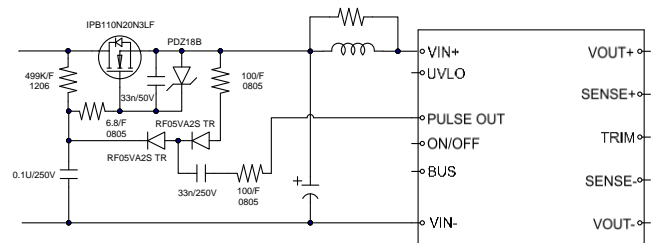

Figure8 An Active Circuit Design for Inrush Current Limit

When pulse out pin is high level, the source current of pulse out pin should be limited no more than 10mA. For resistive load, higher than 1.2kohm is necessary.

Remote On/off(Pin4)

The remote On/Off feature on the module can be either negative or positive logic depend on the part number options on the first page.

For Negative logic version, turns the module on during an external logic low and off during a logic high. If the remote on/off feature is not used, please short the On/Off pin to Vin(-).

For Positive logic version, turns the modules on during an external logic high and off during a logic low. If the remote On/Off feature is not used, please leave the On/Off pin to floating.

Remote On/Off can be controlled by an external switch between the On/Off terminal and the Vin(-) terminal. The switch can be an open collector or open drain, as showed in figure9

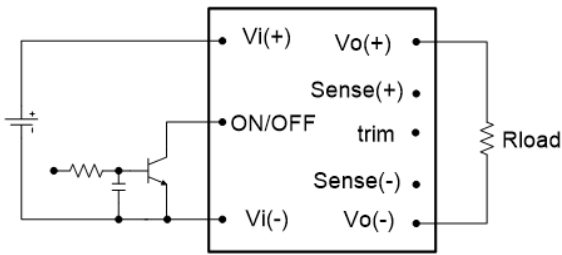

Figure9 Remote On/Off Implementation

Trim(PIN9)

To increase or decrease the output voltage set point, connect an external resistor between the TRIM pin and SENSE (+) pin or SENSE (-) pin. The TRIM pin should be left open if this feature is not used.

Take H80SV12017 as example, for trim down, the external resistor value required to obtain a percentage of output voltage change Δ is defined as:

$$R_{trim-down} = \left[\frac{5.11}{\Delta} - 10.22 \right] (K\Omega)$$

Ex. When Trim-down -10% ($12V \times 0.9 = 10.8V$)

$$R_{trim-down} = \left[\frac{5.11}{10\%} - 10.22 \right] (K\Omega) = 40.88(K\Omega)$$

For trim up, the external resistor value required to obtain a percentage output voltage change Δ is defined as:

$$R_{trim-up} = \left[\frac{45}{\Delta} + 40 \right] K\Omega$$

Ex. When Trim-up +10% ($12V \times 110\% = 13.2V$)

$$R_{trim-up} = \left[\frac{45}{10\%} + 40 \right] = 490(K\Omega)$$

	Rtrim-up /kohm	Rtrim-down /kohm
H80SV12017	$\frac{45}{\Delta} + 40$	$\frac{5.11}{\Delta} - 10.22$
H80SV15013	$\frac{57.46}{\Delta} + 52.35$	$\frac{5.11}{\Delta} - 10.22$
H80SV24008	$\frac{95}{\Delta} + 90$	$\frac{5.11}{\Delta} - 10.22$
H80SV48004	$\frac{195}{\Delta} + 190$	$\frac{5.11}{\Delta} - 10.22$
H80SV54002	$\frac{220}{\Delta} + 215$	$\frac{5.11}{\Delta} - 10.22$
	Rtrim-up /kohm	Rtrim-down /kohm
H80SV12017	$\frac{45}{\Delta} + 40$	$\frac{5.11}{\Delta} - 10.22$
H80SV15013	$\frac{57.46}{\Delta} + 52.35$	$\frac{5.11}{\Delta} - 10.22$
H80SV24008	$\frac{95}{\Delta} + 90$	$\frac{5.11}{\Delta} - 10.22$

H80SV48004	$\frac{195}{\Delta} + 190$	$\frac{5.11}{\Delta} - 10.22$
H80SV54002	$\frac{220}{\Delta} + 215$	$\frac{5.11}{\Delta} - 10.22$

Design considerations

Input Source Impedance

A C-L-C filter circuit (figure10) comprises C2, L1, C1 is recommended placed at the input of H80SV module. C2 is a 100uF CAP and keep the input voltage stable. L1, C1,C3 depress the high frequency ripple current flow into C2. R5 helps to avoid LC resonant in burst mode operating when output load is low.

Location	description
C1,C3	1uF MLCC or film cap
C3	100uF cap
L1	3.3uH inductor
R5	3.01ohm/1w

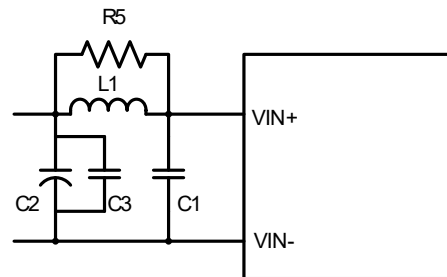

Figure 10 input filter design

Bus Cap and Resistor

An electrolytic cap (C3) about 200uF and a resistor (R3) 3ohm connected between bus and Vin- is necessary. The cap provides/absorb transient power and make the DCDC operating stable. The series resistor R3 is recommended to depress the high frequency ripple current flow into C3.

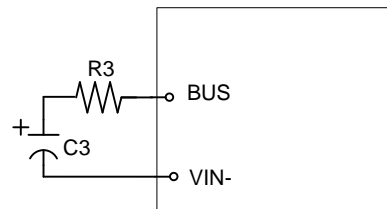

Figure 11 BUS pin circuit

The bus pin is a voltage source depends on input

voltage, the relationship is showed in below table and also the recommended rate voltage of C3

Vin/V	24	48	72	96	110
Vbus/V	90	90	90	96	110
Vrate of C3	>=100V			>=160V	

The power loss on R3 should be taken into account

1. In steady operating status, R3 consumes 0.3w in steady operating.
2. During start-up transient, C3 is charged through R3, which endures a pulse power loss about 20w/15ms. The test condition is as below:
VIN=137.5V, C3=240uF, R3=3ohm, the VIN rise slew rate=10V/ms.

Based on the 2 points above, we recommend below parts for R3.

WF25S3R0JTL(WASIN),3ohm/J 2512, or
SG73P2BTDD6R04F(KOA) 6.04ohm/F 1206 ,2pcs parallel connected

The hold-up time circuit

Hold-up time circuit comprises R4, D1, C4, showed in figure 12. The capacity of C4 decides the hold-up time during interruption of input power. The relationship is showed in below table. The maximum hold-up time is 30ms, and is not able to be enlarged by adding more cap. The rated voltage of C4 is same with C3.

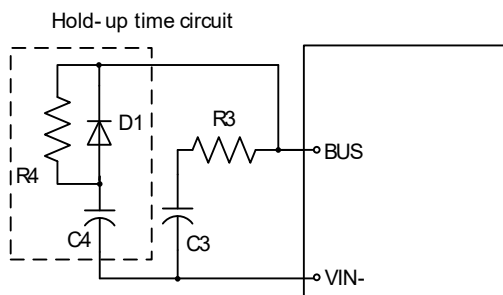

Figure 12 hold-up time circuit

Model	Vin	24V	36V	48V	72V	96V	110V
		Capacitance					
12007	For 10 mS	900u			450u	300uF	
	For 30 mS	2200u			1350u	900uF	
15013	For 10 mS	1200u			500u	350u	
	For 30 mS	2800u			1500u	1000u	
24004	For 10 mS	900u			450u	300u	
	For 30 mS	2200u			1350u	900u	
48002	For 10 mS	1500u			600u	400u	
	For 30 mS	3600u			1800u	1200u	
	For 10 mS	1500u			600u	400u	

54002	For 30 mS	3600u	1800u	1200u
-------	-----------	-------	-------	-------

During start up, R4 endures a high pulse power, and should be selected carefully. The power is related to Vin and C4. We recommend part number for R4 as below:

WHS7-100RJ07 (TT Electronics) 100ohm.

Safety Considerations

The power module must be installed in compliance with the spacing and separation requirements of the end-user's safety agency standard, i.e., IEC 62368-1: 2014 (2nd edition), EN 62368-1: 2014 (2nd edition), UL 62368-1, 2nd Edition, 2014-12-01 and CSA C22.2 No. 62368-1-14, 2nd Edition, 2014-12. IEC 60950-1: 2005, 2nd Edition + A1: 2009 + A2: 2013, EN 60950-1: 2006 + A11: 2009 + A1: 2010 + A12: 2011 + A2: 2013, UL 60950-1, 2nd Edition, 2011-10-14 and CSA C22.2 No. 60950-1-07, 2nd Edition, 2010-14, if the system in which the power module is to be used must meet safety agency requirements.

Reinforced insulation is provided between the input and output of the module. Input is considered as hazardous voltage secondary circuit which main transient is up to 1500Vpk and output is considered as SELV circuit at least basic insulation shall be provided between the hazardous voltage secondary circuit and AC mains/Primary circuit. The input terminals of the module are not considered as operator accessible.

A SELV reliability test may require when install on the system where the module is used, in combination with the module, to ensure that under a single fault, hazardous voltage does not appear at the module's output.

This power module is not internally fused. To achieve optimum safety and system protection, an input line fast-acting fuse with 20A is highly recommended. Further evaluation should be considered if other type and rated of fuse is used.

Soldering and Cleaning Considerations

Post solder cleaning is usually the final board assembly process before the board or system undergoes electrical testing. Inadequate cleaning and/or drying may lower the reliability of a power module and severely affect the finished circuit board assembly test. Adequate cleaning and/or drying is especially important for un-encapsulated and/or open frame type power modules. For assistance on appropriate soldering and cleaning procedures, please contact Delta's technical support team

Thermal considerations

The thermal curve is based on the test setup shown as figure13. The module is mounted on an Al plate and was cooled by cooling liquid.

Figure14 shows the location to monitor the temperature of the module's baseplate. The baseplate temperature in thermal curve is a reference for customer to make thermal evaluation and make sure the module is operated under allowable temperature.

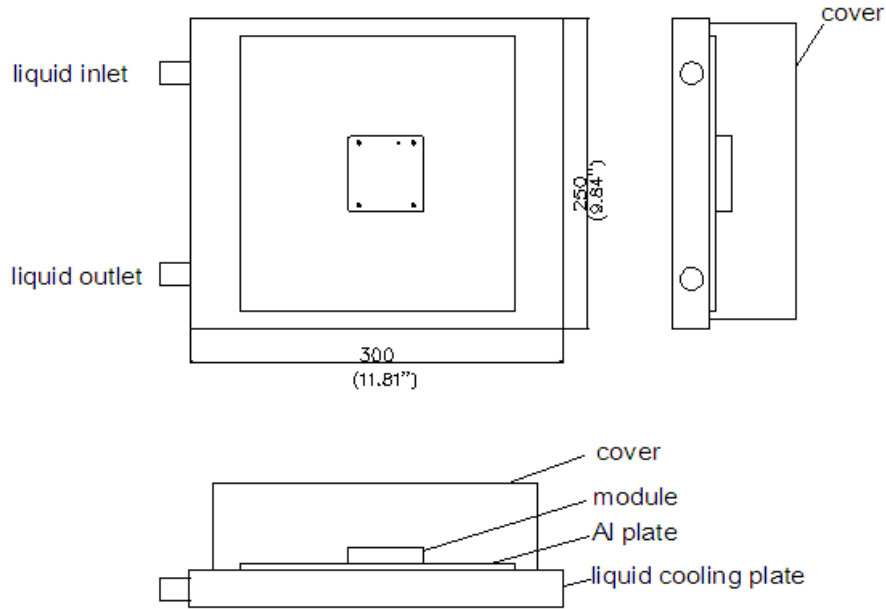

Figure 13: Test setup

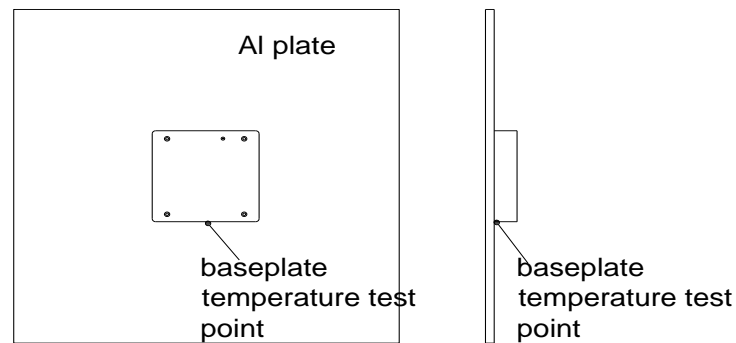
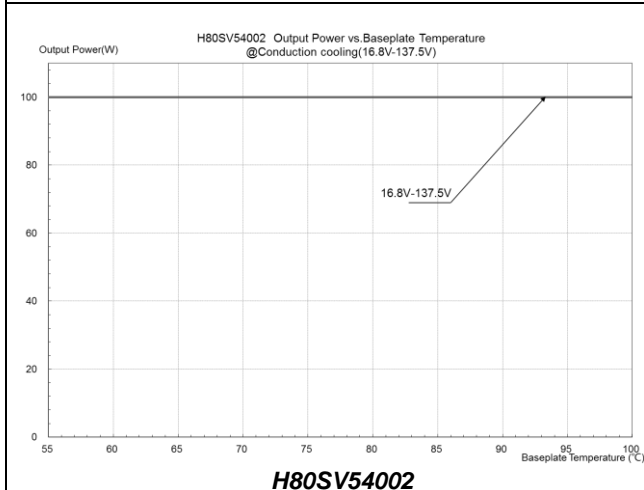
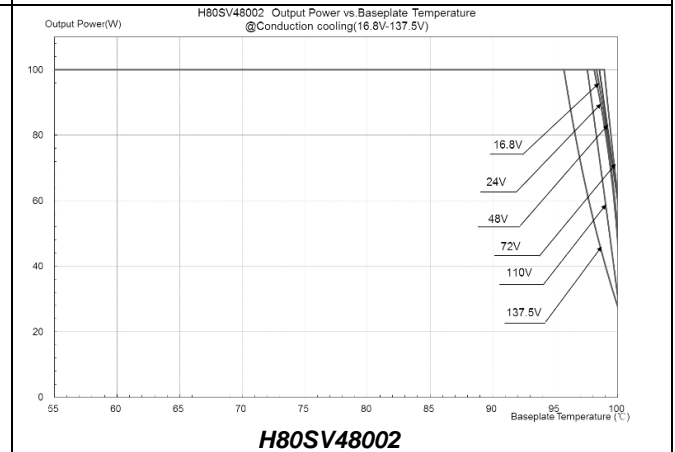
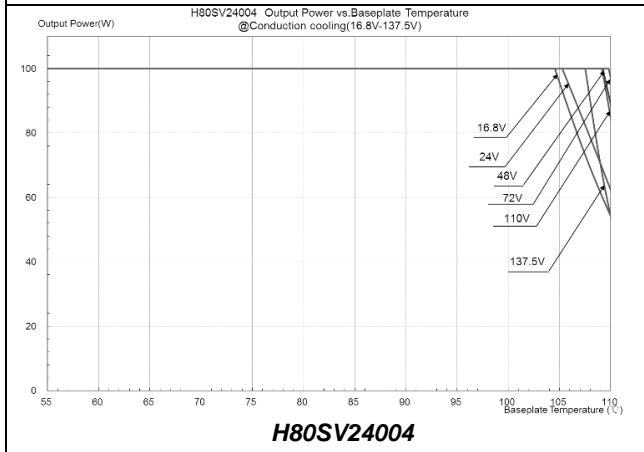
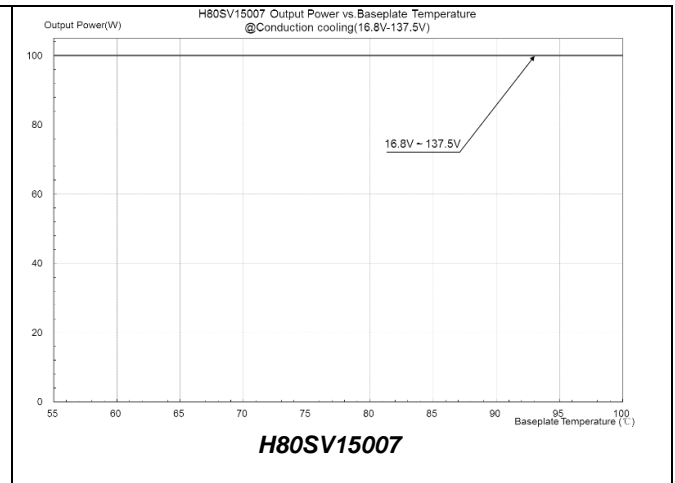
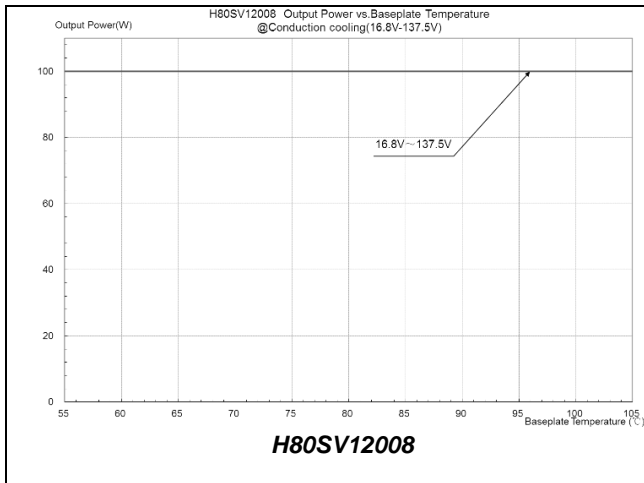

Figure 14: Temperature measured point

Thermal curves



CONTACT: www.deltaww.com/dcdc

USA:

Telephone:
East Coast: 978-656-3993
West Coast: 510-668-5100
Fax: (978) 656 3964

Email: dcdc@deltaww.com

Europe:

Phone: +31-20-655-0967
Fax: +31-20-655-0999

Asia & the rest of world:

Telephone: +886 3 4526107
ext 6220~6226
Fax: +886 3 4513485

WARRANTY

Delta offers a two (2) year limited warranty. Complete warranty information is listed on our web site or is available upon request from Delta.

Information furnished by Delta is believed to be accurate and reliable. However, no responsibility is assumed by Delta for its use, nor for any infringements of patents or other rights of third parties, which may result from its use. No license is granted by implication or otherwise under any patent or patent rights of Delta. Delta reserves the right to revise these specifications at any time, without notice.

X-ON Electronics

Largest Supplier of Electrical and Electronic Components

Click to view similar products for [Isolated DC/DC Converters](#) category:

Click to view products by [Delta](#) manufacturer:

Other Similar products are found below :

[ESM6D044440C05AAQ](#) [FMD15.24G](#) [PSL486-7LR](#) [Q48T30020-NBB0](#) [JAHW100Y1](#) [SPB05C-12](#) [SQ24S15033-PS0S](#) [18952](#) [19-130041](#)
[CE-1003](#) [CE-1004](#) [GQ2541-7R](#) [RDS180245](#) [MAU228](#) [J80-0041NL](#) [DFC15U48D15](#) [XGS-0512](#) [XGS-1205](#) [XGS-1212](#) [XGS-2412](#) [XGS-2415](#) [XKS-1215](#) [06322](#) [NCT1000N040R050B](#) [SPB05B-15](#) [SPB05C-15](#) [L-DA20](#) [DCG40-5G](#) [QME48T40033-PGB0](#) [XKS-2415](#) [XKS-2412](#)
[XKS-1212](#) [XKS-1205](#) [XKS-0515](#) [XKS-0505](#) [XGS-2405](#) [XGS-1215](#) [XGS-0515](#) [PS9Z-6RM4](#) [73-551-5038I](#) [AK1601-9RT](#) [VI-N61-CM](#) [VI-R5022-EXWW](#) [PSC128-7iR](#) [RPS8-350ATX-XE](#) [DAS1004812](#) [PQA30-D24-S24-DH](#) [VI-M5F-CQ](#) [VI-LN2-EW](#) [VI-PJW01-CZY](#)