

# DELPHI SERIES

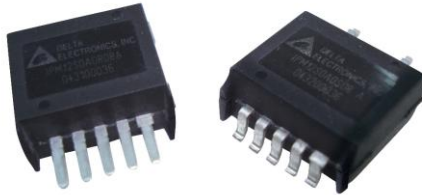

## FEATURES

- ◆ High efficiency: 91% @ 12Vin, 5V/4A out
- ◆ Small size and low profile:  
17.8 x 15.0 x 7.8mm (0.70" x 0.59" x 0.31")
- ◆ Output voltage adjustment: 0.9V~5V
- ◆ Monotonic startup into normal and pre-biased loads
- ◆ Input UVLO, output OCP
- ◆ Remote ON/OFF(Positive)
- ◆ Output short circuit protection
- ◆ Fixed frequency operation
- ◆ Copper pad to provide excellent thermal performance
- ◆ ISO 9001, TL 9000, ISO 14001, QS9000, OHSAS18001 certified manufacturing
- ◆ UL/cUL 60950 (US & Canada) Recognized, and TUV (EN60950) Certified
- ◆ CE mark meets 73/23/EEC and 93/68/EEC directives

## Delphi Series IPM, Non-Isolated, Integrated Point-of-Load Power Modules: 8V~14V input, 0.9~5V and 4A Output Current

The Delphi Series IPM12C non-isolated, fully integrated Point-of-Load (POL) power modules, are the latest offerings from a world leader in power systems technology and manufacturing -- Delta Electronics, Inc. This product family provides up to 4A of output current or 20W of output power in an industry standard, compact, IC-like, molded package. It is highly integrated and does not require external components to provide the point-of-load function. A copper pad on the back of the module, in close contact with the internal heat dissipation components, provides excellent thermal performance. The assembly process of the modules is fully automated with no manual assembly involved. These converters possess outstanding electrical and thermal performance, as well as extremely high reliability under highly stressful operating conditions. IPM12C operates from an 8V~14V source and provides a programmable output voltage of 0.9V to 5V. The IPM product family is available in both a SMD or SIP package.

## OPTION

- ◆ SMD or SIP package

## APPLICATIONS

- ◆ Telecom/ DataCom
- ◆ Wireless Networks
- ◆ Optical Network Equipment
- ◆ Server and Data Storage
- ◆ Industrial/Test Equipment

# TECHICAL SPECIFICATIONS

T<sub>A</sub> = 25°C, airflow rate = 300 LFM, V<sub>in</sub> = 12Vdc, nominal V<sub>out</sub> unless otherwise noted.

PARAMETER	NOTES and CONDITIONS	IPM12C0A0R/S04FA			
		Min.	Typ.	Max.	Units
<b>ABSOLUTE MAXIMUM RATINGS</b>					
Input Voltage (Continuous)		0		15	Vdc
Operating Temperature	Refer to figure 35 for measuring point	-40		113	°C
Storage Temperature		-55		+125	°C
<b>INPUT CHARACTERISTICS</b>					
Operating Input Voltage		8	12	14	V
Input Under-Voltage Lockout					
Turn-On Voltage Threshold			7.9		V
Turn-Off Voltage Threshold			7.6		V
Maximum Input Current	V <sub>in</sub> =V <sub>in,min</sub> to V <sub>in,max</sub> , I <sub>o</sub> =I <sub>o,max</sub>			4.5	A
No-Load Input Current				85	mA
Off Converter Input Current			3	10	mA
Input Reflected-Ripple Current	P-P 1μH inductor, 5Hz to 20MHz		20	40	mAp-p
Input Voltage Ripple Rejection	120 Hz		TBD		dB
<b>OUTPUT CHARACTERISTICS</b>					
Output Voltage Set Point	V <sub>in</sub> =12V, I <sub>o</sub> =I <sub>o,max</sub> , T <sub>a</sub> =25°C	0.889	0.900	0.911	Vdc
Output Voltage Adjustable Range		0.8		5	V
Output Voltage Regulation					
Over Line	V <sub>in</sub> =V <sub>in,min</sub> to V <sub>in,max</sub>		0.1		% V <sub>o,set</sub>
Over Load	I <sub>o</sub> =I <sub>o,min</sub> to I <sub>o,max</sub>		0.3		% V <sub>o,set</sub>
Over Temperature	T <sub>a</sub> =T <sub>a,min</sub> to T <sub>a,max</sub>		0.01	0.025	%V <sub>o,set</sub> /°C
Total Output Voltage Range	Over sample load, line and temperature	-3.0		+3.0	% V <sub>o,set</sub>
Output Voltage Ripple and Noise	5Hz to 20MHz bandwidth				
Peak-to-Peak	Full Load, 1μF ceramic, 10μF tantalum		40	60	mVp-p
RMS	Full Load, 1μF ceramic, 10μF tantalum		15	30	mV
Output Current Range		0		4	A
Output Voltage Over-shoot at Start-up	V <sub>in</sub> =10V to 14V, I <sub>o</sub> =0A to 4A, T <sub>a</sub> =25°C		0	1	% V <sub>o,set</sub>
Output DC Current-Limit Inception			200		% I <sub>o</sub>
<b>DYNAMIC CHARACTERISTICS</b>					
Dynamic Load Response	10μF Tan & 1μF Ceramic load cap, 2.5A/μs				
Positive Step Change in Output Current	50% I <sub>o,max</sub> to 100% I <sub>o,max</sub>		100	150	mVpk
Negative Step Change in Output Current	100% I <sub>o,max</sub> to 50% I <sub>o,max</sub>		100	150	mVpk
Setting Time to 10% of Peak Deviation			40		μs
Turn-On Transient	I <sub>o</sub> =I <sub>o,max</sub>				
Start-Up Time, From On/Off Control			35	45	ms
Start-Up Time, From Input			35	45	ms
Output Voltage Rise Time	Time for V <sub>o</sub> to rise from 10% to 90% of V <sub>o,set</sub> ,	5	17	25	ms
Maximum Output Startup Capacitive Load	Full load; ESR $\geq$ 1mΩ			1500	μF
	Full load; ESR $\geq$ 10mΩ			5000	μF
<b>EFFICIENCY</b>					
V <sub>o</sub> =0.9V	V <sub>in</sub> =12V, I <sub>o</sub> =I <sub>o,max</sub> , T <sub>a</sub> =25°C	73.0	75.0		%
V <sub>o</sub> =1.2V	V <sub>in</sub> =12V, I <sub>o</sub> =I <sub>o,max</sub> , T <sub>a</sub> =25°C	77.0	79.5		%
V <sub>o</sub> =1.5V	V <sub>in</sub> =12V, I <sub>o</sub> =I <sub>o,max</sub> , T <sub>a</sub> =25°C	80.0	82.0		%
V <sub>o</sub> =1.8V	V <sub>in</sub> =12V, I <sub>o</sub> =I <sub>o,max</sub> , T <sub>a</sub> =25°C	82.5	84.0		%
V <sub>o</sub> =2.5V	V <sub>in</sub> =12V, I <sub>o</sub> =I <sub>o,max</sub> , T <sub>a</sub> =25°C	85.5	86.5		%
V <sub>o</sub> =3.3V	V <sub>in</sub> =12V, I <sub>o</sub> =I <sub>o,max</sub> , T <sub>a</sub> =25°C	87.5	88.5		%
V <sub>o</sub> =5.0V	V <sub>in</sub> =12V, I <sub>o</sub> =I <sub>o,max</sub> , T <sub>a</sub> =25°C	90.0	91.0		%
<b>FEATURE CHARACTERISTICS</b>					
Switching Frequency			485		kHz
<b>ON/OFF Control, (Logic High-Module ON)</b>					
Logic High	Module On	2.4		V <sub>in,max</sub>	V
Logic Low	Module Off	-0.2		0.8	V
ON/OFF Current	I <sub>on/off</sub> at V <sub>on/off</sub> =0		0.25	1	mA
Leakage Current	Logic High, V <sub>on/off</sub> =5V			50	μA
<b>GENERAL SPECIFICATIONS</b>					
MTBF	I <sub>o</sub> =80% I <sub>o,max</sub> , T <sub>a</sub> =25°C		15.4		M hours
Weight			6		grams



# ELECTRICAL CHARACTERISTICS CURVES

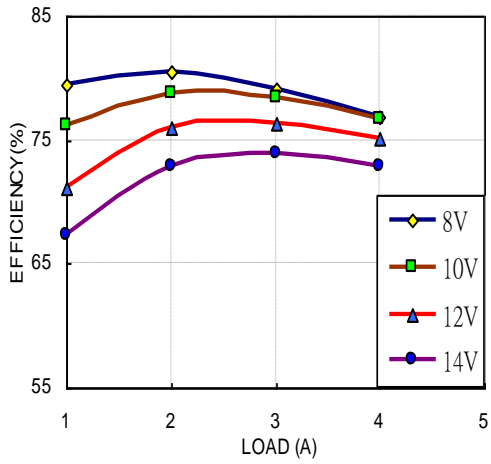

**Figure 1:** Converter efficiency vs. output current (0.90V output voltage)

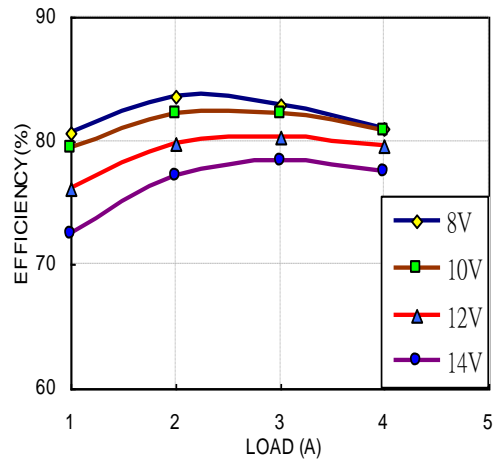

**Figure 2:** Converter efficiency vs. output current (1.2V output voltage)

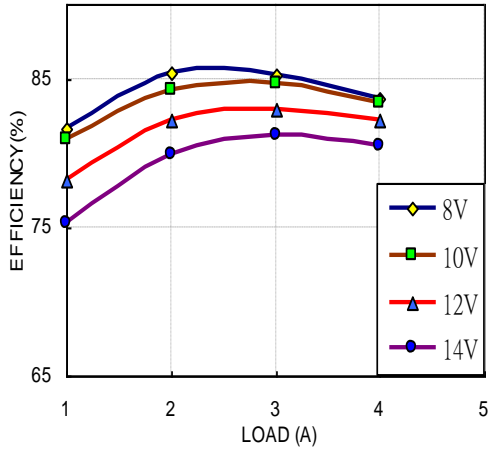

**Figure 3:** Converter efficiency vs. output current (1.5V output voltage)

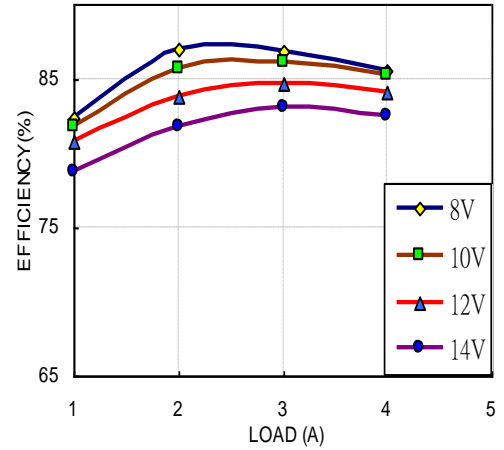

**Figure 4:** Converter efficiency vs. output current (1.8V output voltage)

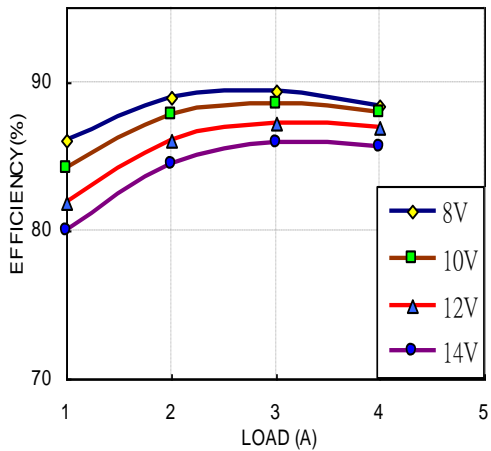

**Figure 5:** Converter efficiency vs. output current (2.5V output voltage)

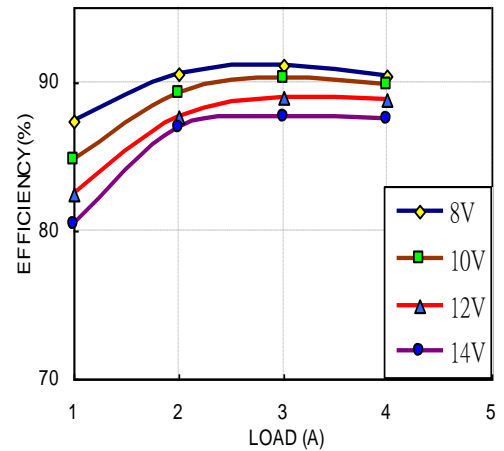

**Figure 6:** Converter efficiency vs. output current (3.3V output voltage)



# ELECTRICAL CHARACTERISTICS CURVES

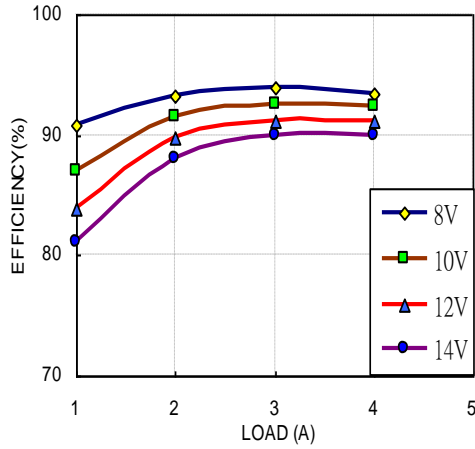

Figure 7: Converter efficiency vs. output current (5.0V output voltage)

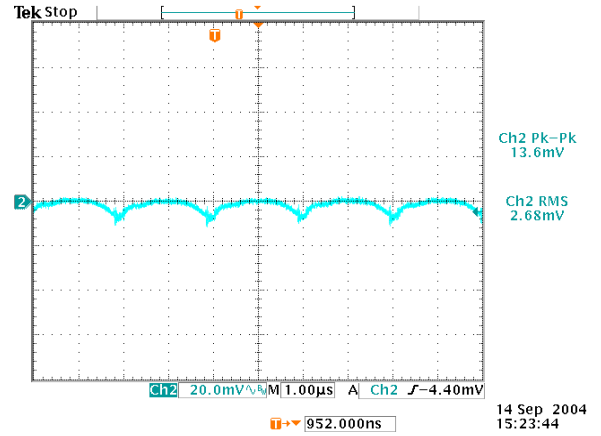

Figure 8: Output ripple & noise at 12Vin, 0.9V/4A out

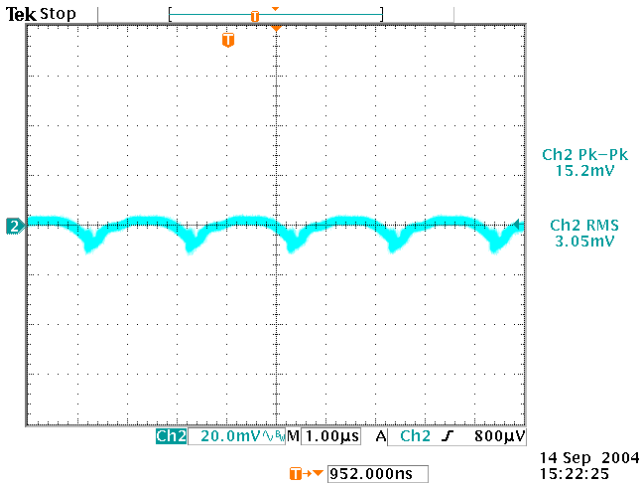

Figure 9: Output ripple & noise at 12Vin, 1.2V/4A out

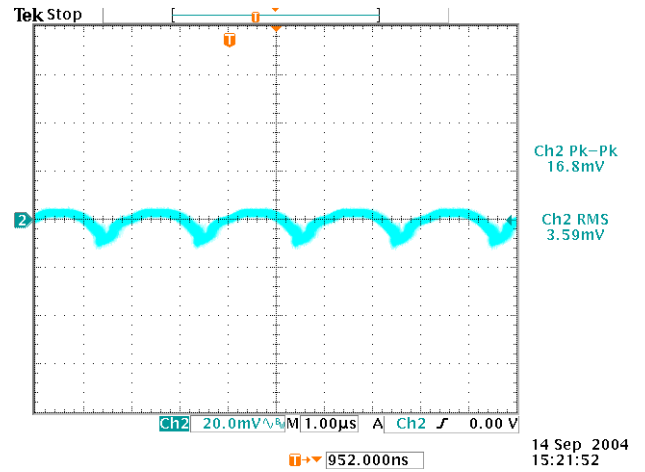

Figure 10: Output ripple & noise at 12Vin, 1.5V/4A out

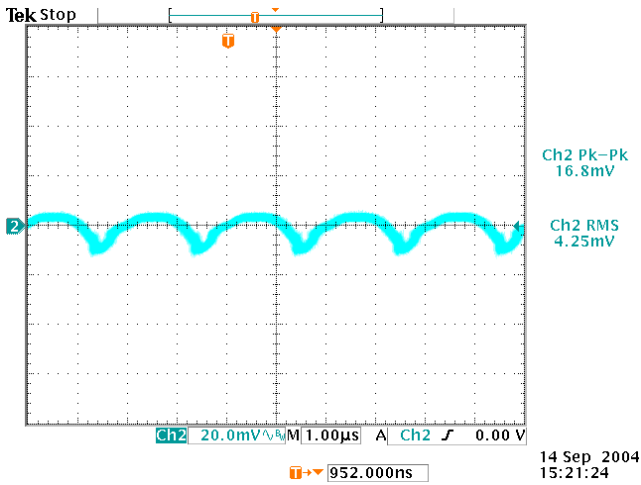

Figure 11: Output ripple & noise at 12Vin, 1.8V/4A out

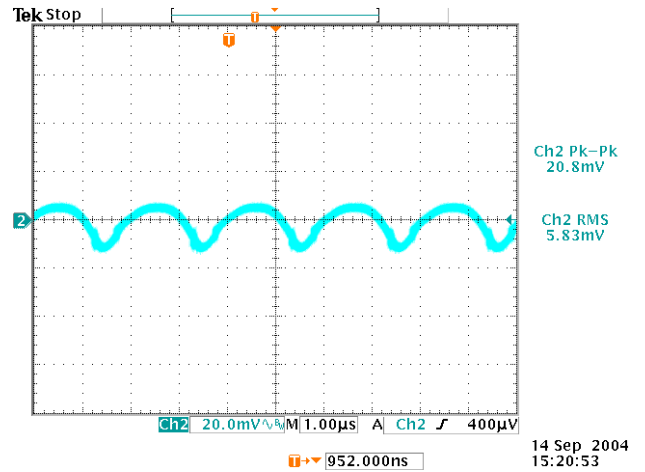

Figure 12: Output ripple & noise at 12Vin, 2.5V/4A out



# ELECTRICAL CHARACTERISTICS CURVES

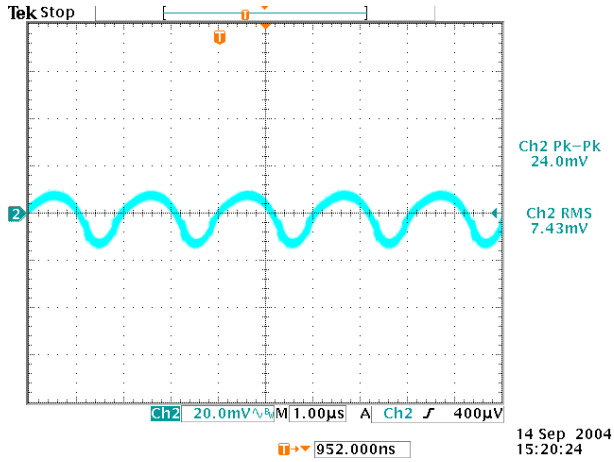

Figure 13: Output ripple & noise at 12Vin, 3.3V/4A out

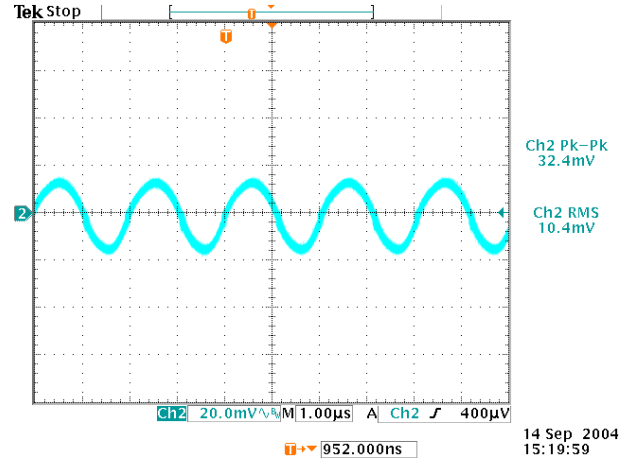

Figure 14: Output ripple & noise at 12Vin, 5.0V/4A out

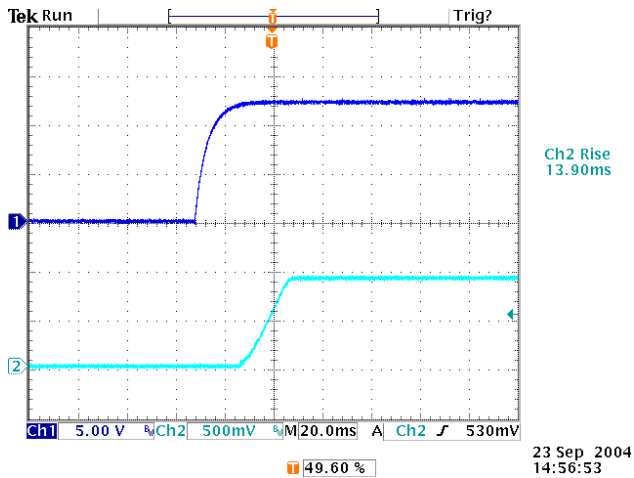

Figure 15: Power on waveform at 12vin, 0.9V/4A out with application of Vin

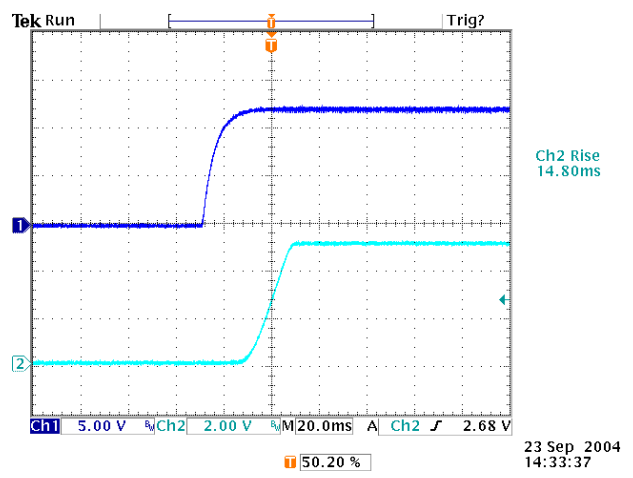

Figure 16: Power on waveform at 12vin, 5V/4A out with application of Vin

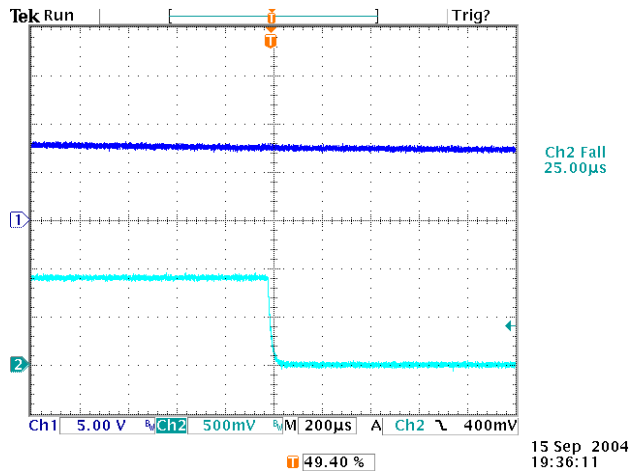

Figure 17: Power off waveform at 12vin, 0.9V/4A out with application of Vin

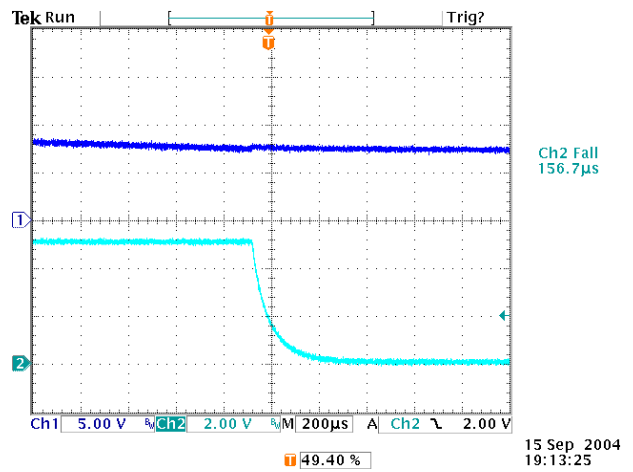

Figure 18: Power off waveform at 12vin, 5.0V/4A out with application of Vin



# ELECTRICAL CHARACTERISTICS CURVES

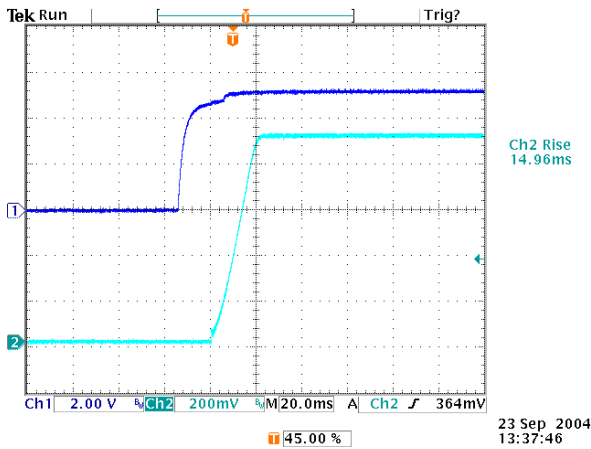

Figure 19: Remote turn on delay time at 12vin, 0.9V/4A out

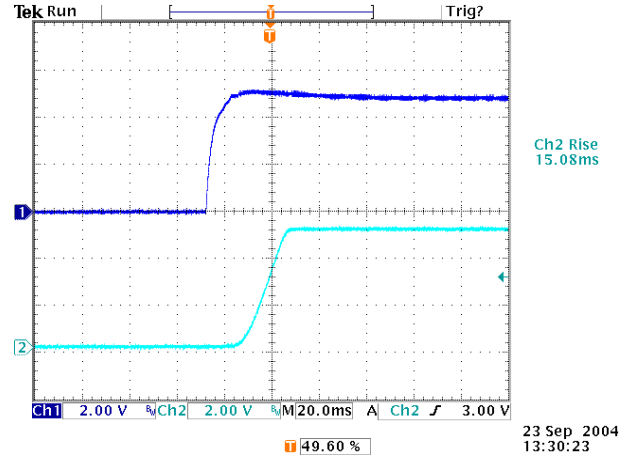

Figure 20: Remote turn on delay time at 12vin, 5.0V/4A out

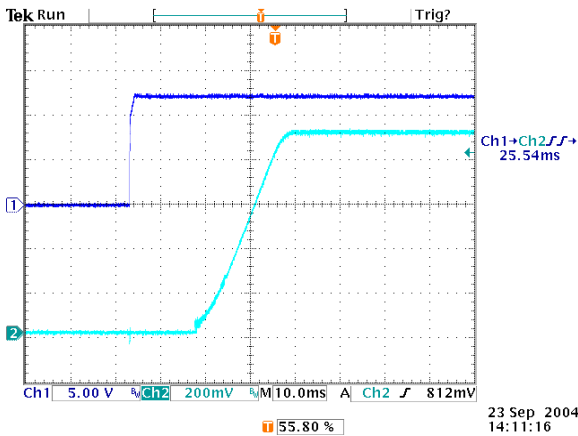

Figure 21: Turn on delay at 12vin, 0.9V/4A out with application of Vin

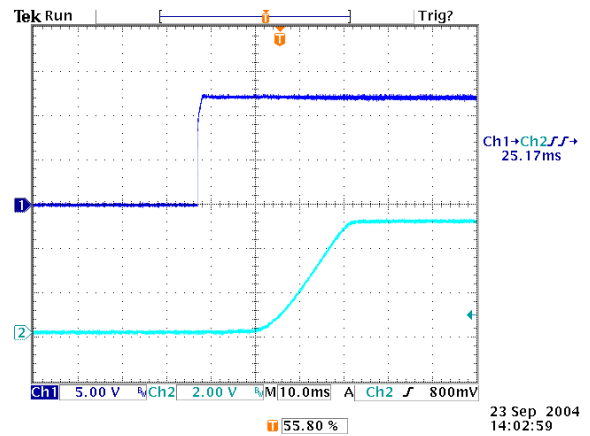

Figure 22: Turn on delay at 12vin, 5.0V/4A out with application of Vin

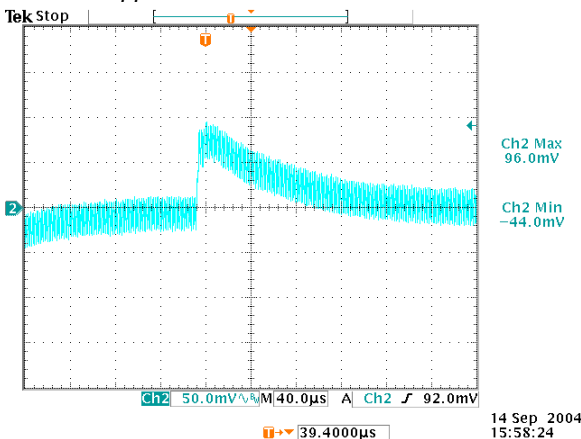

Figure 23: Typical transient response to step load change at 2.5A/μS from 100% to 50% of Io, max at 12Vin, 5.0V out (measurement with a 1uF ceramic and a 10μF tantalum)

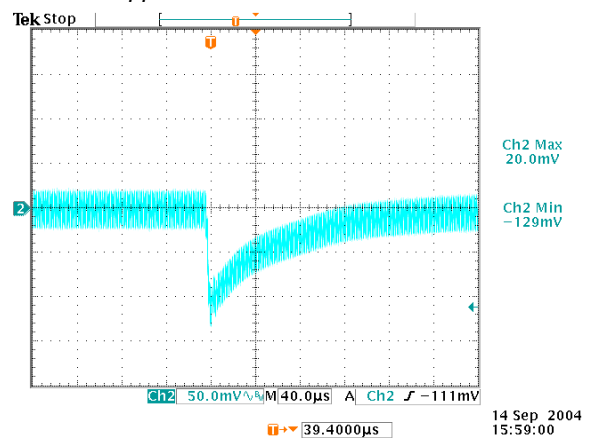
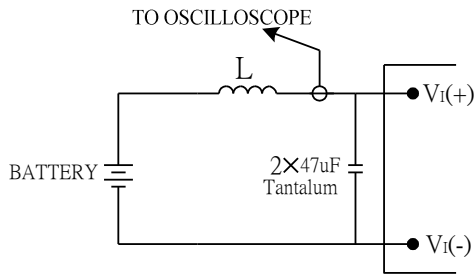

Figure 24: Typical transient response to step load change at 2.5A/μS from 50% to 100% of Io, max at 12Vin, 5.0V out (measurement with a 1uF ceramic and a 10μF tantalu)



## TEST CONFIGURATIONS



Note: Input reflected-ripple current is measured with a simulated source inductance. Current is measured at the input of the module.

**Figure 25:** Input reflected-ripple current test setup

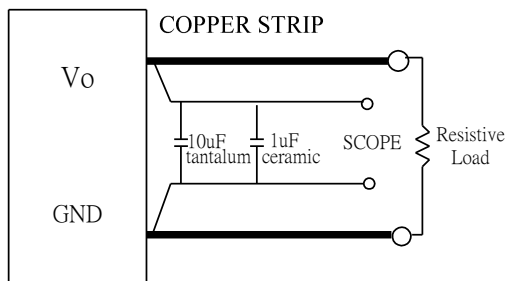

Note: Use a 10 $\mu$ F tantalum and 1 $\mu$ F capacitor. Scope measurement should be made using a BNC connector.

**Figure 26:** Peak-peak output noise and startup transient measurement test setup

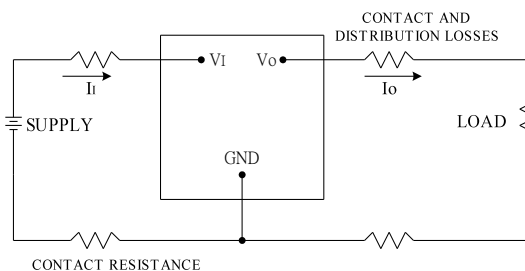

**Figure 27:** Output voltage and efficiency measurement test setup

Note: All measurements are taken at the module terminals. When the module is not soldered (via socket), place Kelvin connections at module terminals to avoid measurement errors due to contact resistance.

$$\eta = \left( \frac{V_o \times I_o}{V_i \times I_i} \right) \times 100 \%$$

DS\_IPM12C0A0R04\_03202007

## DESIGN CONSIDERATIONS

### Input Source Impedance

To maintain low-noise and ripple at the input voltage, it is critical to use low ESR capacitors at the input to the module. Figure 28 shows the input ripple voltage (mVp-p) for various output models using 2x47 uF low ESR tantalum capacitors (SANYO P/N:16TPB470M, 47uF/16V or equivalent) or 2x22 uF very low ESR ceramic capacitors (TDK P/N:C3225X7S1C226MT, 22uF/16V or equivalent).

The input capacitance should be able to handle an AC ripple current of at least:

$$I_{rms} = I_{out} \sqrt{\frac{V_{out}}{V_{in}} \left( 1 - \frac{V_{out}}{V_{in}} \right)} \quad A_{rms}$$

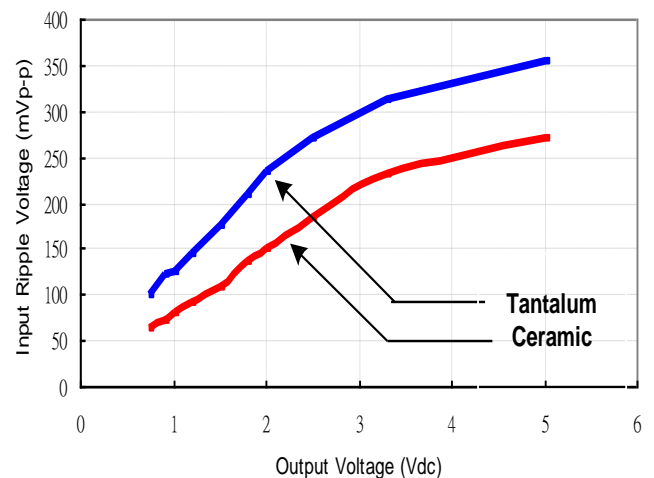

**Figure 28:** Input ripple voltage for various output models,  $I_o = 4A$  ( $C_{in} = 2 \times 47\mu F$  tantalum capacitors or  $2 \times 22\mu F$  ceramic capacitors at the input)

The power module should be connected to a low ac-impedance input source. Highly inductive source impedances can affect the stability of the module. An input capacitance must be placed close to the modules input pins to filter ripple current and ensure module stability in the presence of inductive traces that supply the input voltage to the module.

## DESIGN CONSIDERATIONS

### Safety Considerations

For safety-agency approval the power module must be installed in compliance with the spacing and separation requirements of the end-use safety agency standards.

For the converter output to be considered meeting the requirements of safety extra-low voltage (SELV), the input must meet SELV requirements. The power module has extra-low voltage (ELV) outputs when all inputs are ELV.

The input to these units is to be provided with a maximum 10A time-delay fuse in the ungrounded lead.

### Remote On/Off

The IPM series power modules have an On/Off control pin for output voltage remote On/Off operation. The On/Off pin is an open collector/drain logic input signal that is referenced to ground. When On/Off control pin is not used, leave the pin unconnected.

The remote on/off pin is internally connected to +Vin through an internal pull-up resistor. Figure 29 shows the circuit configuration for applying the remote on/off pin. The module will execute a soft start ON when the transistor Q1 is in the off state.

The typical rise for this remote on/off pin at the output voltage of 2.5V and 5.0V are shown in Figure 17 and 18.

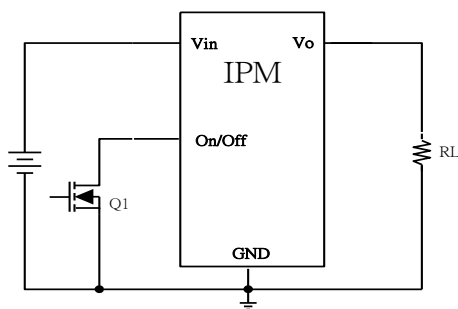

Figure 29: Remote on/off implementation

## FEATURES DESCRIPTIONS

### Over-Current Protection

To provide protection in an output over load fault condition, the unit is equipped with internal over-current protection. When the over-current protection is triggered, the unit enters hiccup mode. The units operate normally once the fault condition is removed.

### Pre-Bias Startup Capability

The IPM would perform the monotonic startup into the pre-bias loads; so as to avoid a system voltage drop occur upon application. In complex digital systems an external voltage can sometimes be presented at the output of the module during power on. This voltage may be feedback through a multi-supply logic component, such as FPGA or ASIC. Another way might be via a clamp diode as part of a power up sequencing implementation.

### Output Voltage Programming

The output voltage of IPM can be programmed to any voltage between 0.8Vdc and 5Vdc by connecting one resistor (shown as Rtrim in Figure 30, 31) between the TRIM and GND pins of the module to trim up (0.9V ~ 5V) and between the Trim and +Output to trim down (0.8V ~ 0.9V). Without this external resistor, the output voltage of the module is 0.9 Vdc. To calculate the value of the resistor Rtrim for a particular output voltage Vo, please use the following equation:

Trim up

$$R_{trim} = \frac{3.752}{V_{out} - 0.9} - 0.261 \text{ (K}\Omega\text{)}$$

Trim Down

$$R_{trim} = \frac{1.072}{0.9 - V_{out}} - 5.621 \text{ (K}\Omega\text{)}$$

Rtrim is the external resistor in K $\Omega$   
Vout is the desired output voltage



## FEATURES DESCRIPTIONS (CON.)

For example: to program the output voltage of the IPM module to 3.3Vdc, Rtrim is calculated as follows:

$$R_{trim} = \frac{3.752}{3.3 - 0.9} - 0.261 \text{ (K}\Omega\text{)}$$

$$R_{trim} = 1.302 \text{ K}\Omega$$

IPM can also be programmed by applying a voltage between the TRIM and GND pins (Figure 32). The following equation can be used to determine the value of Vtrim needed for a desired output voltage Vo:

$$V_{trim} = 0.7439 - 0.0488V_o$$

Vtrim is the external voltage in V  
Vo is the desired output voltage

For example, to program the output voltage of a IPM module to 3.3 Vdc, Vtrim is calculated as follows

$$V_{trim} = 0.7439 - 0.0488 \times 3.3$$

$$V_{trim} = 0.5829\text{V}$$

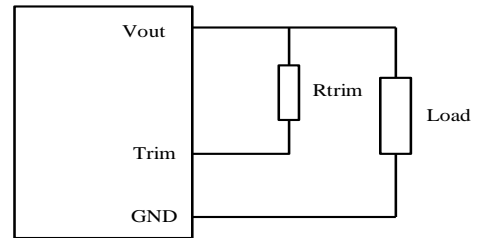

**Figure 31:** *Trim down Circuit* configuration for programming output voltage using an external resistor

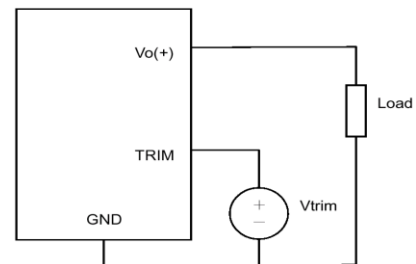

**Figure 32:** *Circuit configuration for programming output voltage using external voltage source*

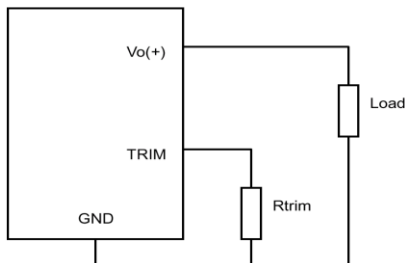

**Figure 30:** *Trim up Circuit* configuration for programming output voltage using an external resistor

## FEATURE DESCRIPTIONS (CON.)

Table 1 provides Rtrim values required for some common output voltages, while Table 2 provides value of external voltage source, Vtrim, for the same common output voltages. By using a 0.5% tolerance resistor, set point tolerance of  $\pm 2\%$  can be achieved as specified in the electrical specification.

**Table 1**

VO (V)	Rtrim ( $\Omega$ )
0.800	5.09K
0.900	Open
1.0	37.2K
1.2	12.2K
1.5	5.99K
1.8	3.90K
2.5	2.08K
3.3	1.30K
5.0	654

**Table 2**

VO (V)	Vtrim (V)
0.80	0.705
0.90	0.700
1.2	0.685
1.5	0.671
1.8	0.656
2.5	0.622
3.3	0.583
5.0	0.500

The amount of power delivered by the module is the voltage at the output terminals multiplied by the output current. When using the trim feature, the output voltage of the module can be increased, which at the same output current would increase the power output of the module. Care should be taken to ensure that the maximum output power of the module must not exceed the maximum rated power ( $V_{o.set} \times I_{o.max} \leq P_{max}$ ).

### Voltage Margining

Output voltage margining can be implemented in the IPM modules by connecting a resistor,  $R_{margin-up}$ , from the Trim pin to the ground pin for margining-up the output voltage and by connecting a resistor,  $R_{margin-down}$ , from the Trim pin to the output pin for margining-down. Figure 33 shows the circuit configuration for output voltage margining. If unused, leave the trim pin unconnected.

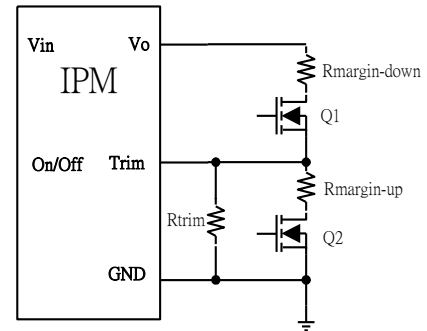

**Figure 33:** Circuit configuration for output voltage margining

## THERMAL CONSIDERATIONS

Thermal management is an important part of the system design. To ensure proper, reliable operation, sufficient cooling of the power module is needed over the entire temperature range of the module. Convection cooling is usually the dominant mode of heat transfer.

Hence, the choice of equipment to characterize the thermal performance of the power module is a wind tunnel.

### Thermal Testing Setup

Delta's DC/DC power modules are characterized in heated vertical wind tunnels that simulate the thermal environments encountered in most electronics equipment. This type of equipment commonly uses vertically mounted circuit cards in cabinet racks in which the power modules are mounted.

The following figure shows the wind tunnel characterization setup. The power module is mounted on a test PWB and is vertically positioned within the wind tunnel. The height of this fan duct is constantly kept at 25.4mm (1").

### Thermal Derating

Heat can be removed by increasing airflow over the module. To enhance system reliability, the power module should always be operated below the maximum operating temperature. If the temperature exceeds the maximum module temperature, reliability of the unit may be affected.

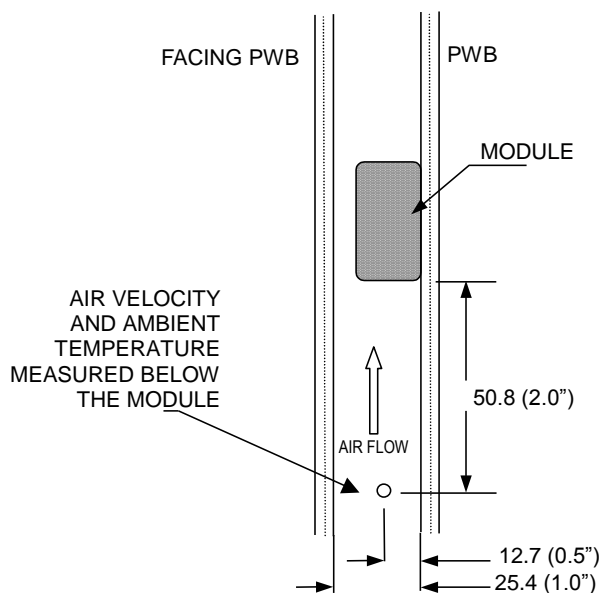

Figure 34: Wind tunnel test setup

DS\_IPM12C0A0R04\_03202007

## THERMAL CURVES

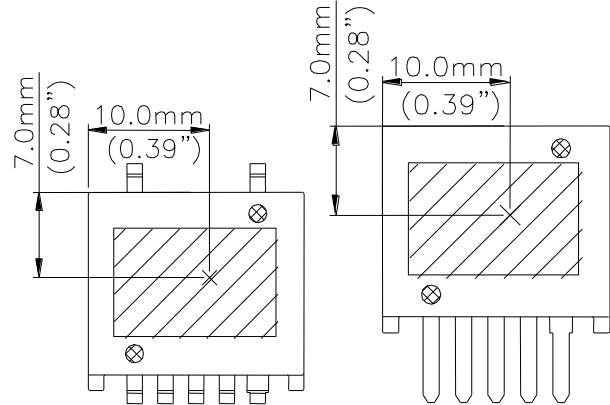

Figure 35: Temperature measurement location

\* The allowed maximum hot spot temperature is defined at 113°C.

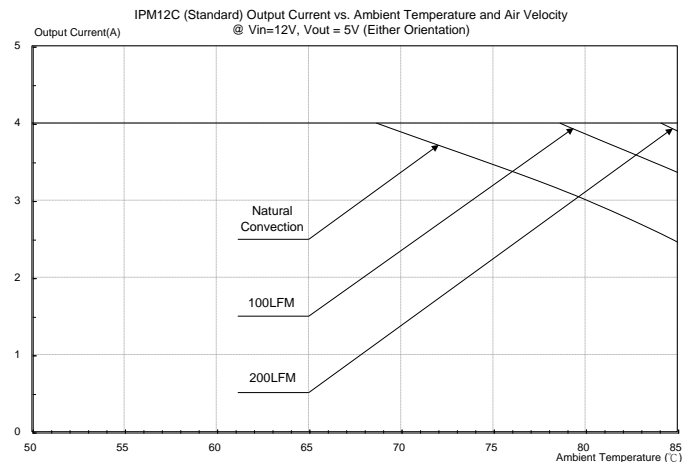

Figure 36: Output current vs. ambient temperature and air velocity @ Vin=12V, Vo=5V

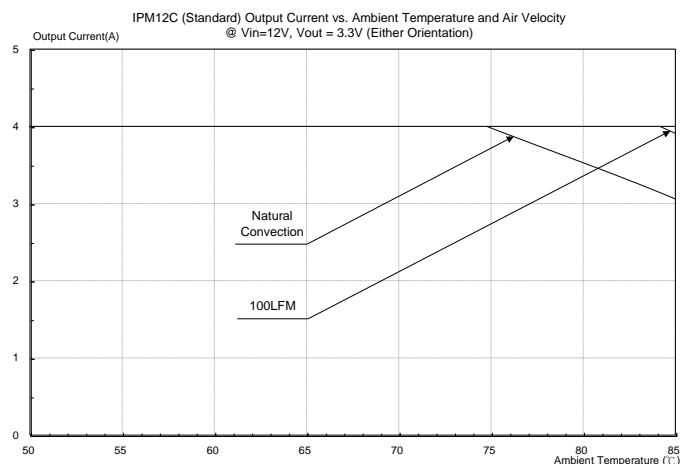
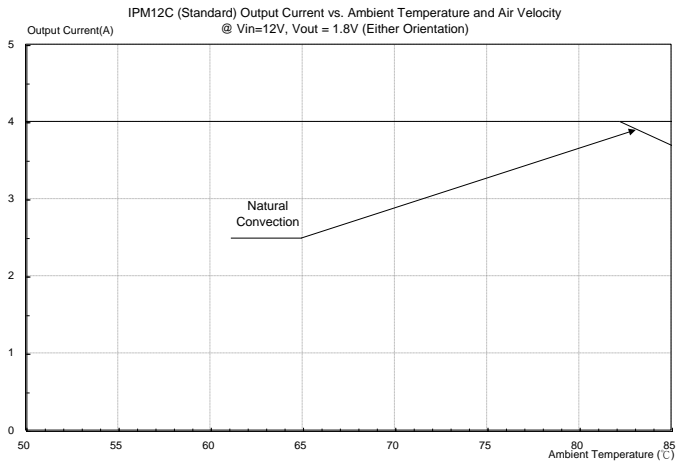
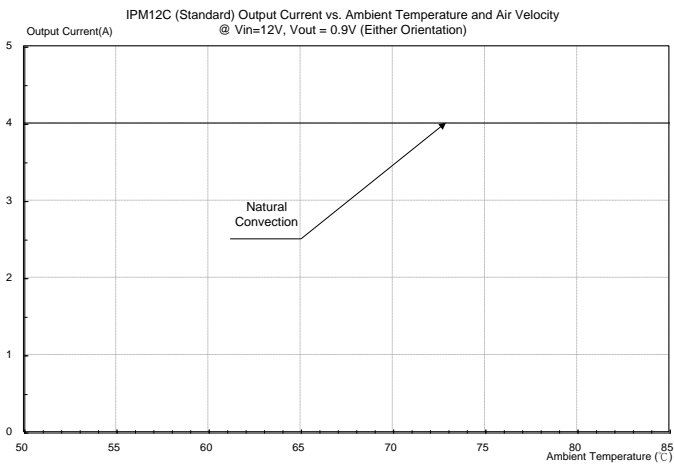

Figure 37: Output current vs. ambient temperature and air velocity @ Vin=12V, Vo=3.3V

# THERMAL CURVES (CON.)



**Figure 38:** Output current vs. ambient temperature and air velocity @ Vin=12V, Vo=1.8V(Either Orientation)



**Figure 39:** Output current vs. ambient temperature and air velocity @ Vin=12V, Vo=0.9V(Either Orientation)



## PICK AND PLACE LOCATION

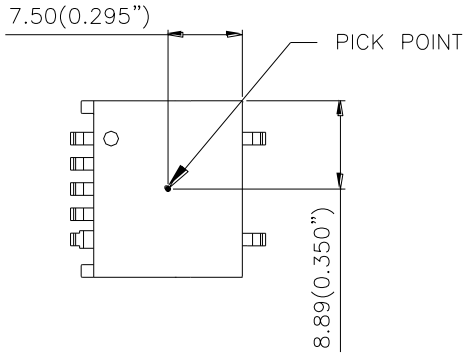

All dimensions are in millimeters (inches)

## SURFACE- MOUNT TAPE & REEL

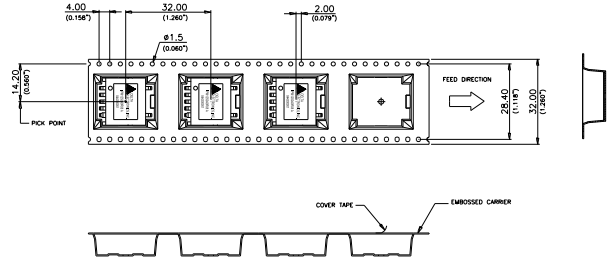

All dimensions are in millimeters (inches)

## LEAD FREE PROCESS RECOMMEND TEMP. PROFILE

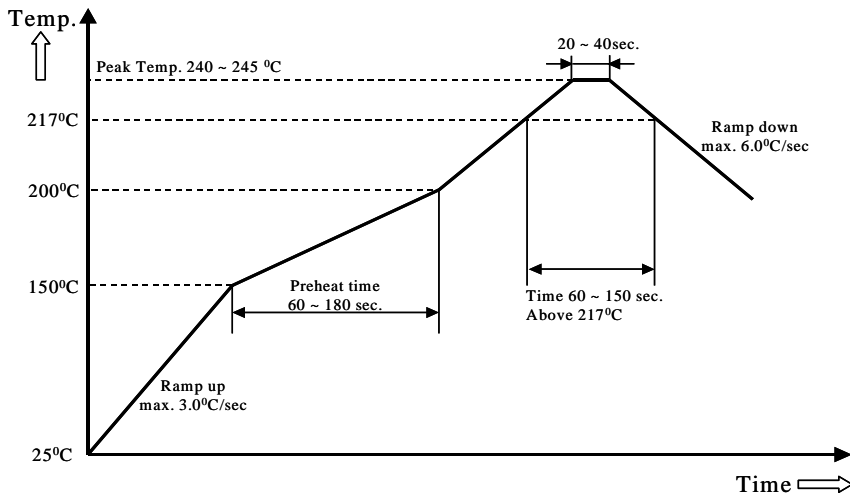

Note: All temperature refers to topside of the package, measured on the package body surface.

# MECHANICAL DRAWING

## SMD PACKAGE

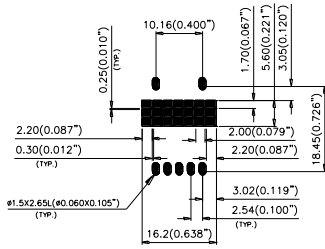
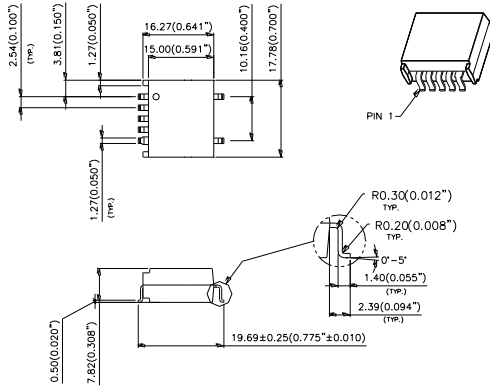

RECOMMEND PWB PAD LAYOUT

## SIP PACKAGE

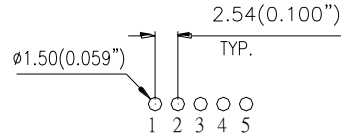
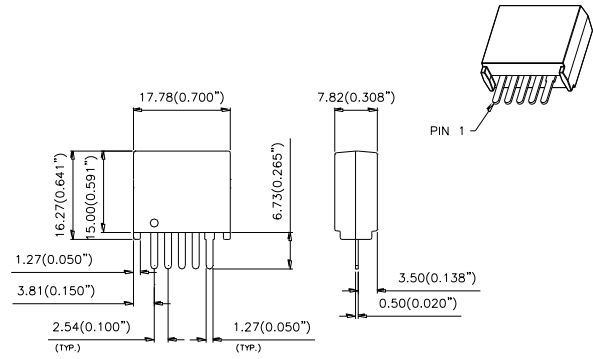

RECOMMEND PWB HOLE LAYOUT

**Note: The copper pad is recommended to connect to the ground.**

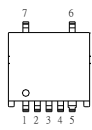

Pin#	Function
1	Remote on/off
2	+Vin
3	Ground
4	+Vo
5	Trim
6	No connection
7	No connection

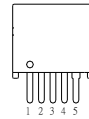

Pin#	Function
1	Remote on/off
2	+Vin
3	Ground
4	+Vo
5	Trim

**Note: All dimension are in millimeters(inches) standard dimension tolerance is  $\pm 0.10(0.004")$**



## PART NUMBERING SYSTEM

IPM	12	C	0A0	R	04	F	A
Product Family	Input Voltage	Number of Outputs	Output Voltage	Package	Output Current		Option Code
Integrated POL Module	12 - 8V ~ 14V	C – Low current	0A0 - programmable output	R - SIP S - SMD	04 - 4A	F- RoHS 6/6 (Lead Free)	A - Standard Function

## MODEL LIST

Model Name	Packaging	Input Voltage	Output Voltage	Output Current	Efficiency (Typical @ full load)
IPM12C0A0R04FA	SIP	8V ~14V	0.8V ~ 5V	4A	91%
IPM12C0A0S04FA	SMD	8V ~14V	0.8V ~ 5V	4A	91%
IPM04C0A0R06FA	SIP	3V ~ 5.5V	0.8V ~ 3.3V	6A	93%
IPM04C0A0S06FA	SMD	3V ~ 5.5V	0.8V ~ 3.3V	6A	93%

**CONTACT:** [www.deltaww.com/dcdc](http://www.deltaww.com/dcdc)

### USA:

Telephone:  
East Coast: 978-656-3993  
West Coast: 510-668-5100  
Fax: (978) 656 3964  
Email: [DCDC@delta-corp.com](mailto:DCDC@delta-corp.com)

### Europe:

Phone: +31-20-655-0967  
Fax: +31-20-655-0999  
Email: [DCDC@delta-es.com](mailto:DCDC@delta-es.com)

### Asia & the rest of world:

Telephone: +886 3 4526107  
ext 6220~6224  
Fax: +886 3 4513485  
Email: [DCDC@delta.com.tw](mailto:DCDC@delta.com.tw)

## WARRANTY

Delta offers a two (2) year limited warranty. Complete warranty information is listed on our web site or is available upon request from Delta.

Information furnished by Delta is believed to be accurate and reliable. However, no responsibility is assumed by Delta for its use, nor for any infringements of patents or other rights of third parties, which may result from its use. No license is granted by implication or otherwise under any patent or patent rights of Delta. Delta reserves the right to revise these specifications at any time, without notice.

## X-ON Electronics

Largest Supplier of Electrical and Electronic Components

*Click to view similar products for [Non-Isolated DC/DC Converters](#) category:*

*Click to view products by [Delta](#) manufacturer:*

Other Similar products are found below :

[BRFS50](#) [APTH003A0X-SRZ](#) [SPM1004-3V3C](#) [R-785.0-05](#) [BRFS30](#) [PJT020A0X43-SRZ](#) [10E24-P15-10PPM](#) [1E24-P4-25PPM-SHV-5KV](#)  
[CA-17205-L4](#) [4D15-N1](#) [MYGTM01210BZN](#) [APXW012A0X3-SRDZ](#) [10C24-N250-I10-AQ-DA](#) [4AA24-P20-M-H](#) [DX150N](#) [3V12-N0.8](#)  
[2HVA24-BP1-F-25PPM-SHV-5KV](#) [5HVA24-BP1-F-25PPM-SHV-5KV](#) [1/2AA24-P30-I10](#) [1C24-P20-M-C](#) [VI-920194B](#) [T31SN24005NMFA](#)  
[3V24-P1](#) [3V24-N1](#) [BMR4672010/001](#) [BMR4652010/001](#) [BMR4668004/001](#) [T31SN12008NMFA](#) [6AA24-P30-I5-M](#) [6AA24-N30-I5-M](#)  
[PTV03020WAH](#) [PTV05020WAH](#) [PTV12010LAH](#) [PTV12020WAD](#) [IBF05012A006V-007-R](#) [IBF12012A007V-007-R](#) [V7806-1500](#)  
[V7806W-500](#) [PTV12020LAH](#) [PTN04050CAZT](#) [PTH12020WAD](#) [I6A24008A033V-N00-R](#) [R-625.0D](#) [R-7212D](#) [R-7212P](#) [R-745.0D](#) [R-](#)  
[78AA15-0.5SMD](#) [R-78AA5.0-1.0SMD](#) [30A24-N15-E](#) [10A12-P4-M](#)