

# DELPHI SERIES

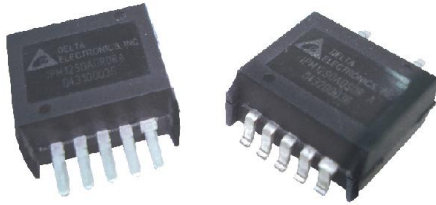

## FEATURES

- High efficiency: 85% @ 12Vin, 2.5V/3A
- 81.5% @ 24Vin, 2.5V/3A    Small size and low profile:  
17.8x15.0x7.8mm (0.70"x0.59"x0.31")
- Output voltage adjustment: 1.2V~2.5V
- Monotonic startup into normal and pre-biased loads
- Input UVLO, output OCP
- Remote ON/OFF
- Output short circuit protection
- Fixed frequency operation
- Copper pad to provide excellent thermal performance
- ISO 9001, TL 9000, ISO 14001, QS9000, OHSAS18001 certified manufacturing facility
- UL/cUL 60950 (US & Canada) Recognized, and TUV (EN60950) Certified
- CE mark meets 73/23/EEC and 93/68/EEC directives

## Delphi Series IPM24S0A0, Non-Isolated, Integrated Point-of-Load Power Modules: 8V~36V input, 1.2~2.5V and 3A Output

The Delphi Series IPM24S0A0 non-isolated, fully integrated Point-of-Load (POL) power modules, are the latest offerings from a world leader in power systems technology and manufacturing – Delta Electronics, Inc. This product family provides up to 3A of output current or 7.5W of output power in an industry standard, compact, IC-like, molded package. It is highly integrated and does not require external components to provide the point-of-load function. A copper pad on the back of the module; in close contact with the internal heat dissipation components; provides excellent thermal performance. The assembly process of the modules is fully automated with no manual assembly involved. These converters possess outstanding electrical and thermal performance, as well as extremely high reliability under highly stressful operating conditions. IPM24S0A0 operates from an 8V~36V source and provides a programmable output voltage from 1.2V to 2.5V. The IPM product family is available in both a SMD or SIP package. IPM24S family is also available for output 3.3~6.5V, please refer to IPM04S0B0 datasheet for details.

## OPTIONS

- SMD or SIP package

## APPLICATIONS

- Telecom/DataCom
- Wireless Networks
- Optical Network Equipment
- Server and Data Storage
- Industrial/Test Equipment

# TECHNICAL SPECIFICATIONS

T<sub>A</sub> = 25°C, airflow rate = 300 LFM, V<sub>in</sub> = 24 Vdc, nominal V<sub>out</sub> unless otherwise noted.

PARAMETER	NOTES and CONDITIONS	IPM24S0A0x03FA			
		Min.	Typ.	Max.	Units
<b>ABSOLUTE MAXIMUM RATINGS</b>					
Input Voltage (Continuous)		0		40	Vdc
Operating Temperature	Please refer to Fig.33 for measuring point	-40		+125	°C
Storage Temperature		-55		+125	°C
<b>INPUT CHARACTERISTICS</b>					
Operating Input Voltage		8		36	V
Input Under-Voltage Lockout					
Turn-On Voltage Threshold			7.3		V
Turn-Off Voltage Threshold			7.4		V
Maximum Input Current	V <sub>in</sub> =V <sub>in,max</sub> to V <sub>in,min</sub> , I <sub>o</sub> =I <sub>o,max</sub>			1.5	A
No-Load Input Current			50		mA
Off Converter Input Current			3	10	mA
Input Reflected-Ripple Current	P-P 0.5μH inductor, 5Hz to 20MHz		60	150	mAp-p
Input Voltage Ripple Rejection	120 Hz		TBD		dB
<b>OUTPUT CHARACTERISTICS</b>					
Output Voltage Set Point	V <sub>in</sub> =24V, I <sub>o</sub> =I <sub>o,max</sub> , T <sub>a</sub> =25°C	1.182	1.2	1.218	Vdc
Output Voltage Adjustable Range		1.2		2.5	V
Output Voltage Regulation					
Over Line	V <sub>in</sub> =V <sub>in,min</sub> to V <sub>in,max</sub>		0.3		% V <sub>o,set</sub>
Over Load	I <sub>o</sub> =I <sub>o,min</sub> to I <sub>o,max</sub>		0.3		% V <sub>o,set</sub>
Over Temperature	T <sub>a</sub> =T <sub>a,min</sub> to T <sub>a,max</sub>		0.01	0.025	%V <sub>o,set</sub> /°C
Total Output Voltage Range	Over sample load, line and temperature	-3.0		+3.0	% V <sub>o,set</sub>
Output Voltage Ripple and Noise	5Hz to 20MHz bandwidth				
Peak-to-Peak	Full Load, 1μF ceramic, 10μF tantalum		30	100	mVp-p
RMS	Full Load, 1μF ceramic, 10μF tantalum		15	30	mV
Output Current Range	V <sub>o</sub> ≤ 2.5Vdc	0		3	A
Output Voltage Over-shoot at Start-up	V <sub>in</sub> =12V to 24V, I <sub>o</sub> =0A to 1.5A, T <sub>a</sub> =25°C		0	1	% V <sub>o,set</sub>
Output DC Current-Limit Inception			200		% I <sub>o</sub>
<b>DYNAMIC CHARACTERISTICS</b>					
Dynamic Load Response	220μF Poscap & 1μF Ceramic load cap, 0.5A/μs				
Positive Step Change in Output Current	50% I <sub>o,max</sub> to 100% I <sub>o,max</sub>		75	200	mVpk
Negative Step Change in Output Current	100% I <sub>o,max</sub> to 50% I <sub>o,max</sub>		75	200	mVpk
Setting Time to 10% of Peak Deviation			200	300	μs
Turn-On Transient	I <sub>o</sub> =I <sub>o,max</sub>				
Start-Up Time, From On/Off Control			17	50	ms
Start-Up Time, From Input			17	50	ms
Output Voltage Rise Time	Time for V <sub>o</sub> to rise from 10% to 90% of V <sub>o,set</sub> ,	5	9	15	ms
Maximum Output Startup Capacitive Load	Full load; ESR <sub>o</sub> ≥ 25mΩ			220	μF
	Full load; ESR <sub>o</sub> ≥ 18mΩ			1220	μF
<b>EFFICIENCY</b>					
V <sub>o</sub> =1.2V	V <sub>in</sub> =12V, I <sub>o</sub> =I <sub>o,max</sub> , T <sub>a</sub> =25°C	75.0	78.0		%
V <sub>o</sub> =1.5V	V <sub>in</sub> =12V, I <sub>o</sub> =I <sub>o,max</sub> , T <sub>a</sub> =25°C	78.0	80.5		%
V <sub>o</sub> =1.8V	V <sub>in</sub> =12V, I <sub>o</sub> =I <sub>o,max</sub> , T <sub>a</sub> =25°C	80.0	82.0		%
V <sub>o</sub> =2.5V	V <sub>in</sub> =12V, I <sub>o</sub> =I <sub>o,max</sub> , T <sub>a</sub> =25°C	83.3	85.0		%
V <sub>o</sub> =1.2V	V <sub>in</sub> =24V, I <sub>o</sub> =I <sub>o,max</sub> , T <sub>a</sub> =25°C	70.0	72.5		%
V <sub>o</sub> =1.5V	V <sub>in</sub> =24V, I <sub>o</sub> =I <sub>o,max</sub> , T <sub>a</sub> =25°C	73.5	75.5		%
V <sub>o</sub> =1.8V	V <sub>in</sub> =24V, I <sub>o</sub> =I <sub>o,max</sub> , T <sub>a</sub> =25°C	76.0	78.0		%
V <sub>o</sub> =2.5V	V <sub>in</sub> =24V, I <sub>o</sub> =I <sub>o,max</sub> , T <sub>a</sub> =25°C	80.0	81.5		%
<b>FEATURE CHARACTERISTICS</b>					
Switching Frequency			150		kHz
ON/OFF Control, (Logic High-Module ON)					
Logic High	Module On	2.4		V <sub>in,max</sub>	V
Logic Low	Module Off	-0.2		0.8	V
ON/OFF Current	I <sub>on/off</sub> at V <sub>on/off</sub> =0		0.25	1	mA
Leakage Current	Logic High, V <sub>on/off</sub> =5V			50	μA
<b>GENERAL SPECIFICATIONS</b>					
Calculated MTBF	I <sub>o</sub> =80% I <sub>o,max</sub> , T <sub>a</sub> =25°C		18.93		M hours
Weight			6		grams



# ELECTRICAL CHARACTERISTICS CURVES

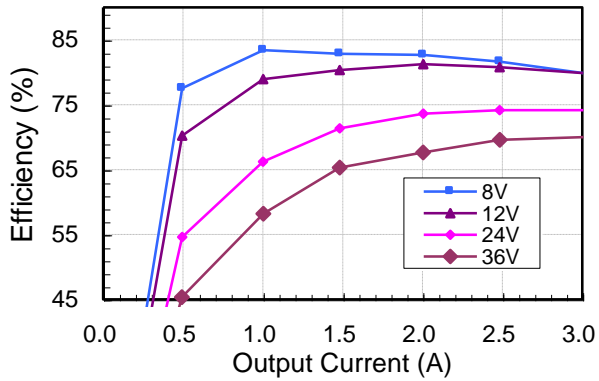

Figure 1: Converter efficiency vs. output current (1.2V output voltage)

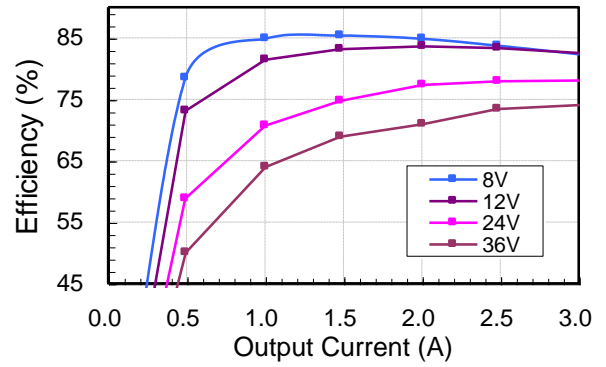

Figure 2: Converter efficiency vs. output current (1.5V output voltage)

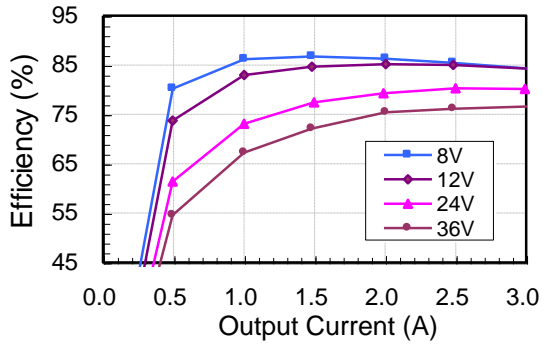

Figure 3: Converter efficiency vs. output current (1.8V output voltage)

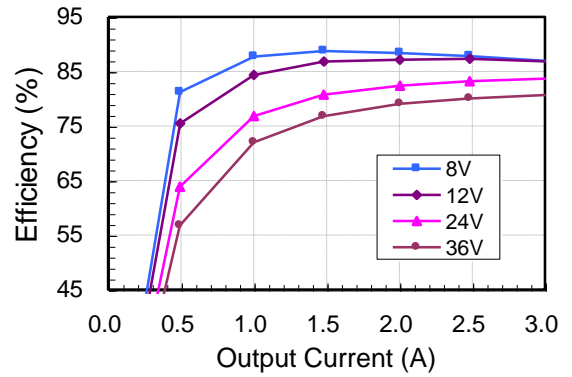

Figure 4: Converter efficiency vs. output current (2.5V output voltage)

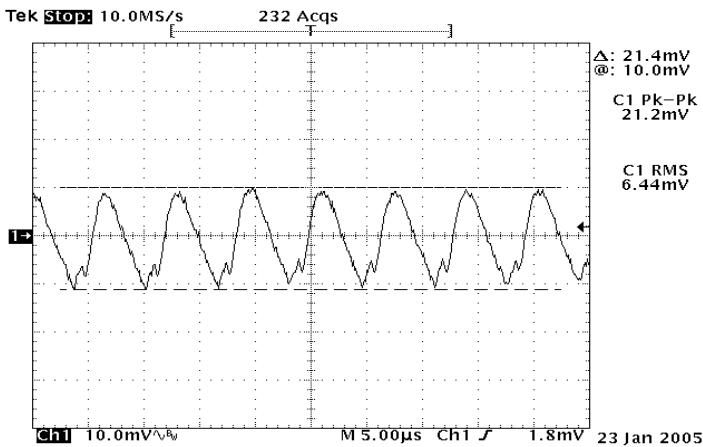

Figure 5: Output ripple & noise at 12Vin, 1.2V/3A out

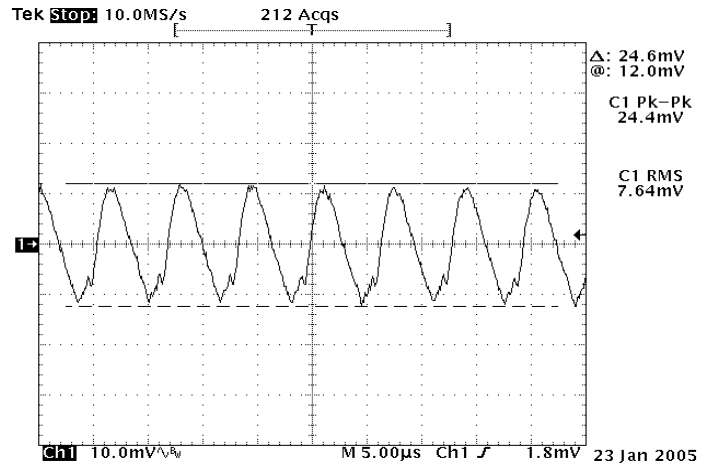

Figure 6: Output ripple & noise at 12Vin, 1.5V/3A out



# ELECTRICAL CHARACTERISTICS CURVES

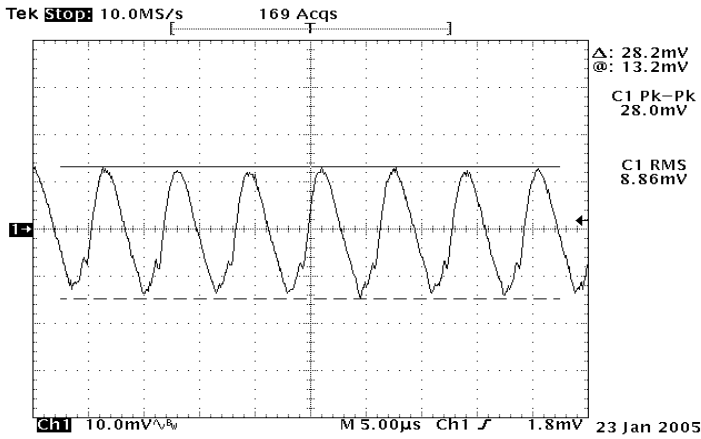

Figure 7: Output ripple & noise at 12Vin, 1.8V/3A out

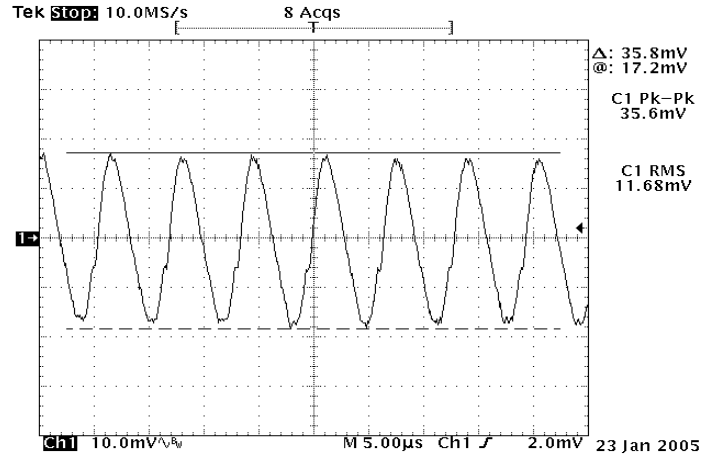

Figure 8: Output ripple & noise at 12Vin, 2.5V/3A out

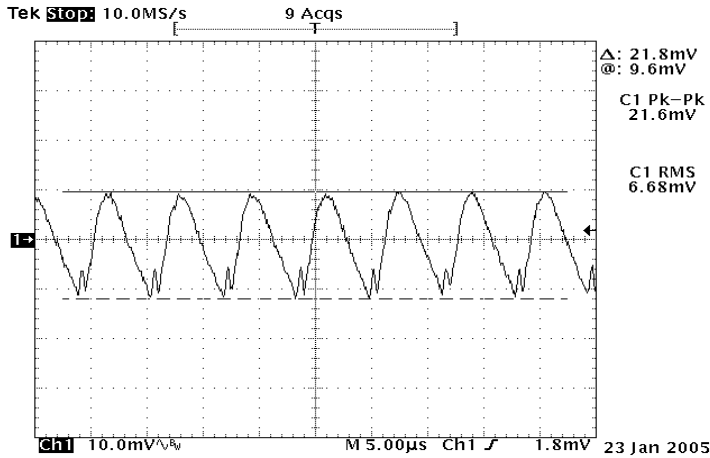

Figure 9: Output ripple & noise at 24Vin, 1.2V/3A out

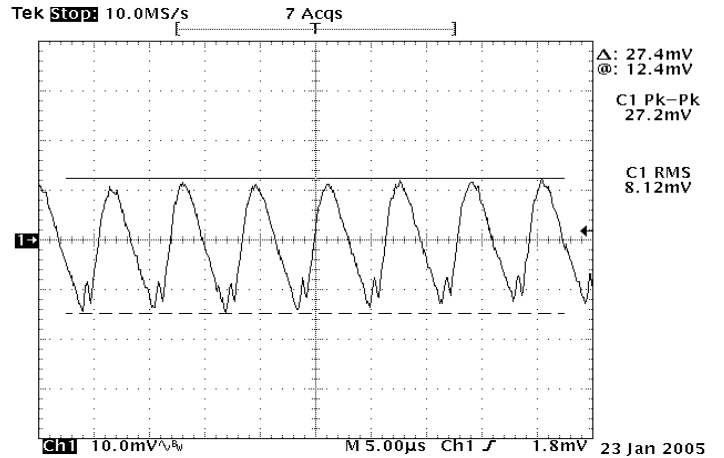

Figure 10: Output ripple & noise at 24Vin, 1.5V/3A out

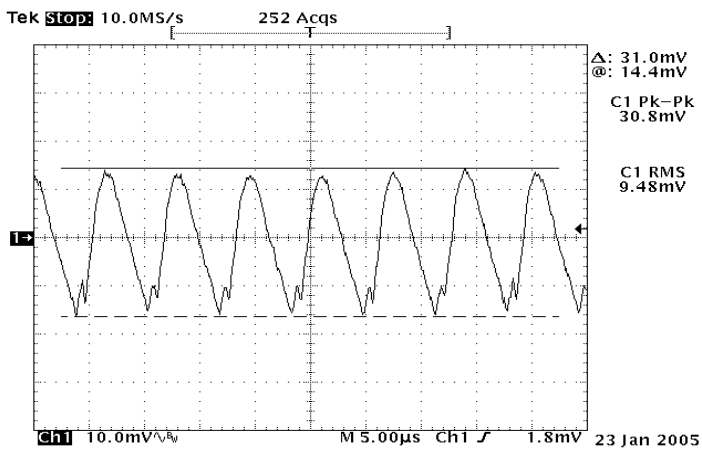

Figure 11: Output ripple & noise at 24Vin, 1.8V/3A out

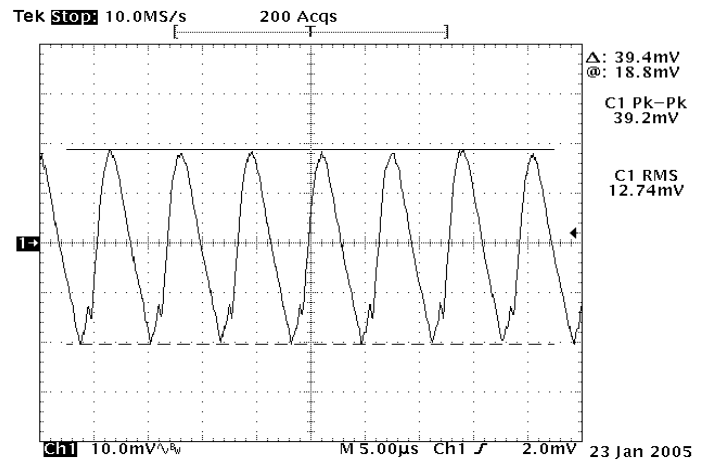

Figure 12: Output ripple & noise at 24Vin, 2.5V/3A out



# ELECTRICAL CHARACTERISTICS CURVES

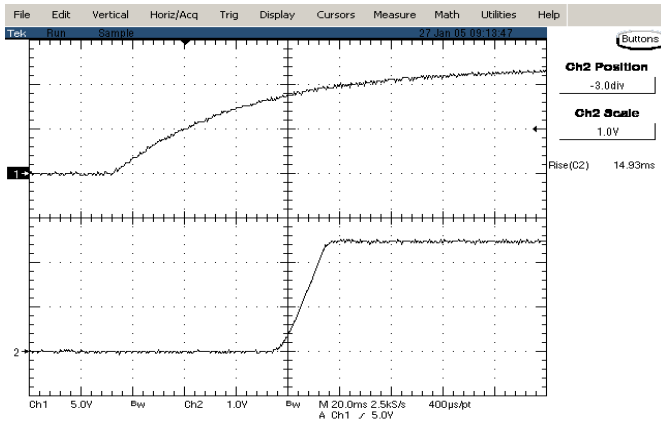

Figure 13: Power on waveform at 12vin, 2.5V/3A out with application of Vin

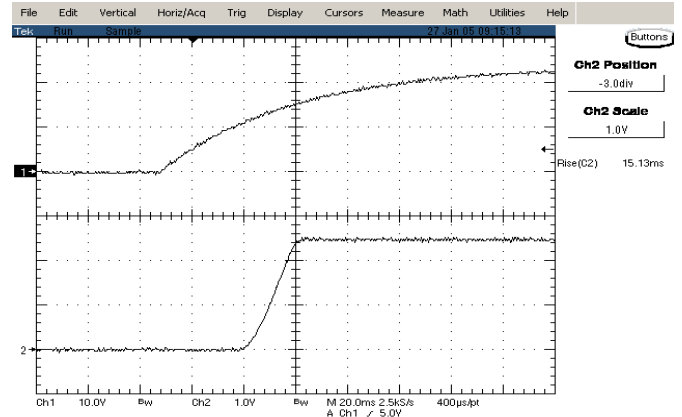

Figure 14: Power on waveform at 24vin, 2.5V/3A out with application of Vin

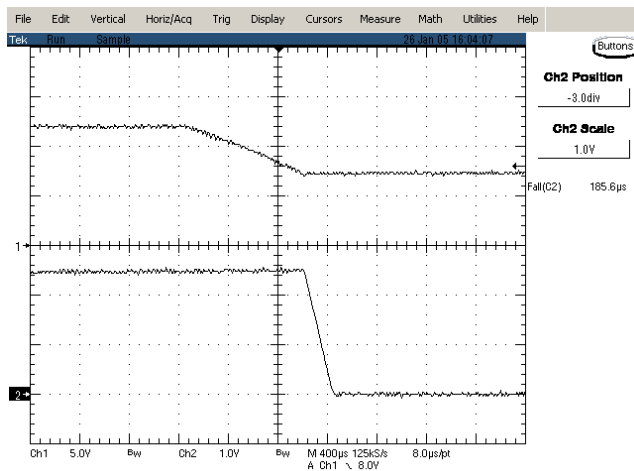

Figure 15: Power off waveform at 12vin, 2.5V/3A out with application of Vin

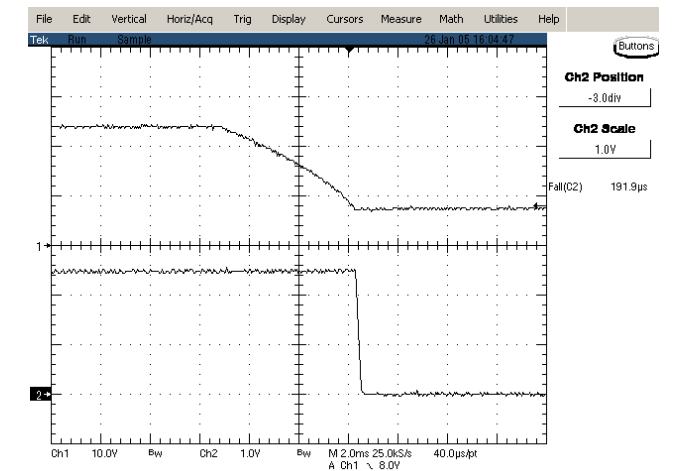

Figure 16: Power off waveform 24vin, 2.5V/3A out with application of Vin

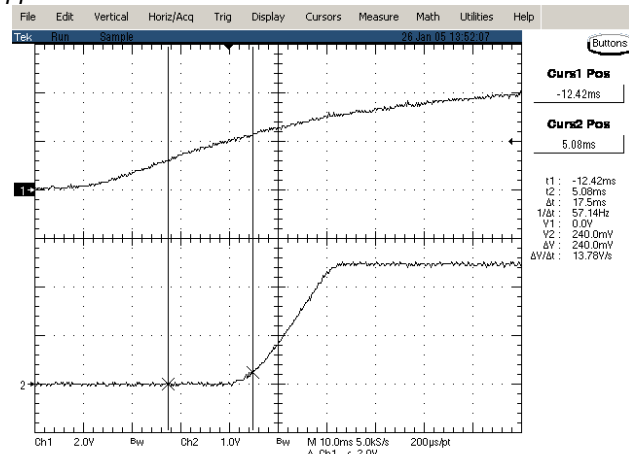

Figure 17: Remote turn on delay time at 24vin, 2.5V/3A out

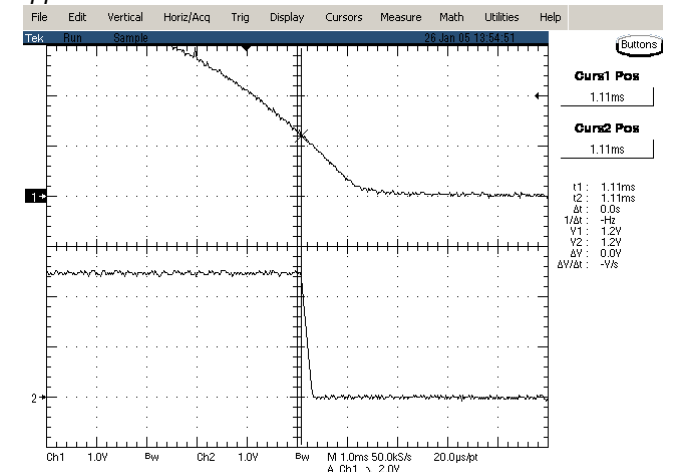

Figure 18: Remote turn off delay time at 24vin, 2.5V/3A out



# ELECTRICAL CHARACTERISTICS CURVES

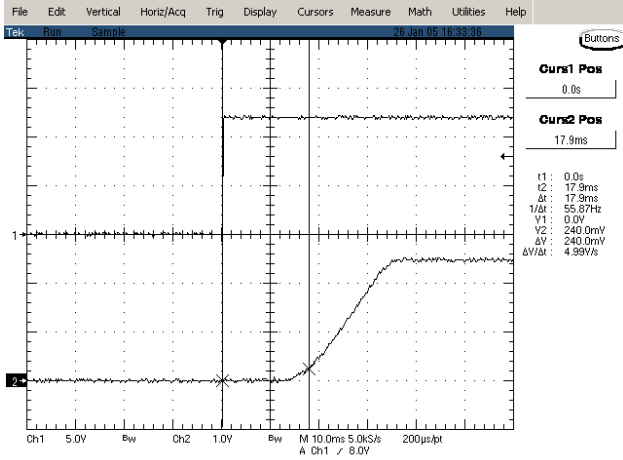

Figure 19: Turn on delay at 12vin, 2.5V/3A out with application of Vin

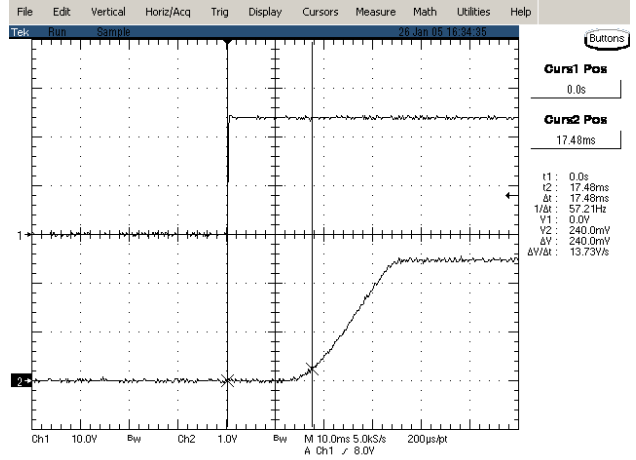

Figure 20: Turn on delay at 24vin, 2.5V/3A out with application of Vin

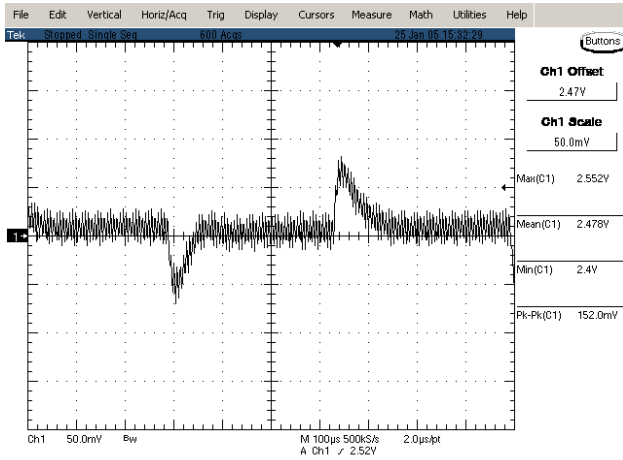

Figure 21: Typical transient response to step load change at 0.5A/μs from 100% to 50% of Io, max at 24Vin, 1.5V out (measurement with a 1uF ceramic and a 220μF Poscap)

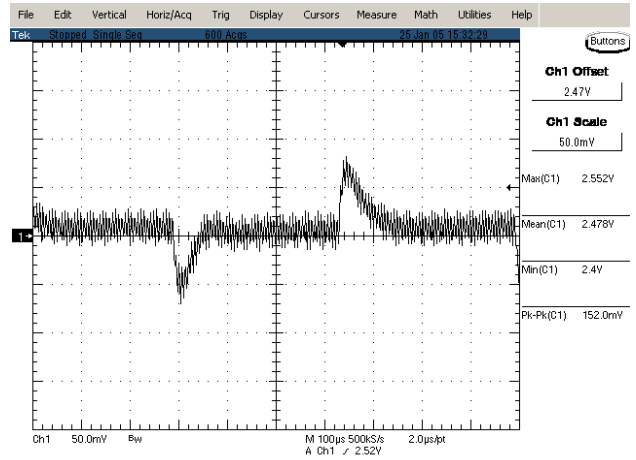
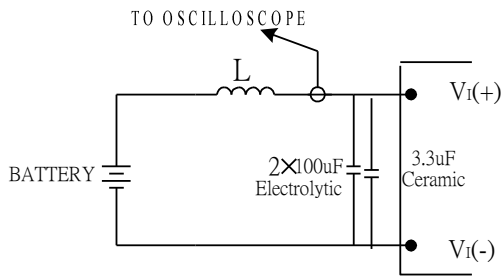

Figure 22: Typical transient response to step load change at 0.5A/μs from 50% to 100% of Io, max at 24Vin, 1.5V out (measurement with a 1uF ceramic and a 220μF Poscap)

## TEST CONFIGURATIONS



Note: Input reflected-ripple current is measured with a simulated source inductance. Current is measured at the input of the module.

**Figure 23:** Input reflected-ripple current test setup

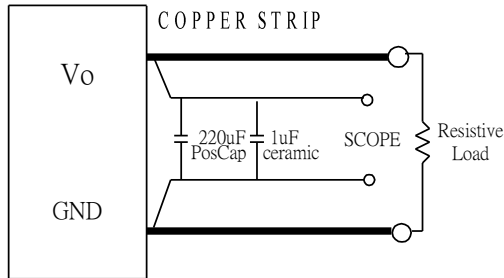

Note: Use a 220µF PosCap and 1µF capacitor. Scope measurement should be made using a BNC connector.

**Figure 24:** Peak-peak output noise and startup transient measurement test setup

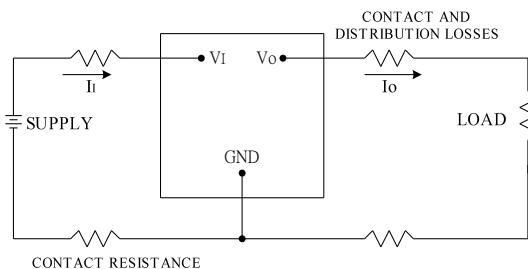

**Figure 25:** Output voltage and efficiency measurement test setup

Note: All measurements are taken at the module terminals. When the module is not soldered (via socket), place Kelvin connections at module terminals to avoid measurement errors due to contact resistance.

$$\eta = \left( \frac{V_o \times I_o}{V_i \times I_i} \right) \times 100 \%$$

DS\_IPM24S0A0\_02262013

## DESIGN CONSIDERATIONS

### Input Source Impedance

To maintain low-noise and ripple at the input voltage, it is critical to use low ESR capacitors at the input to the module. Figure 26 shows the input ripple voltage (mVp-p) for various output models using 2x100µF low ESR electrolytic capacitors (Rubycon P/N:50YXG100, 100µF/50V or equivalent) and 1x3.3.0 µF very low ESR ceramic capacitors (TDK P/N:C4532JB1H335M, 3.3µF/50V or equivalent).

The input capacitance should be able to handle an AC ripple current of at least:

$$I_{rms} = I_{out} \sqrt{\frac{V_{out}}{V_{in}} \left( 1 - \frac{V_{out}}{V_{in}} \right)} \quad A_{rms}$$

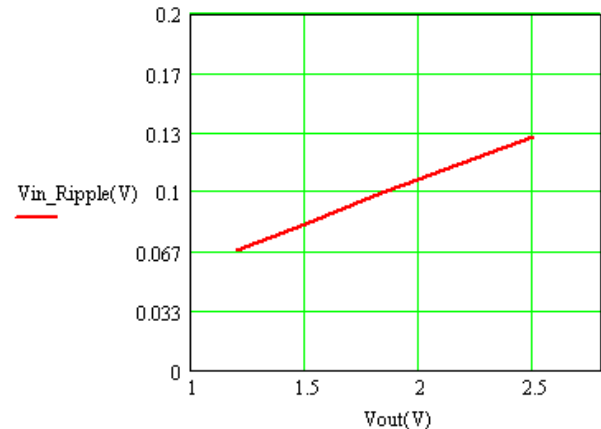

**Figure 26:** Input ripple voltage for various output models,  $I_o = 3A$  ( $C_{in} = 2 \times 100\mu F$  electrolytic capacitors 1x3.3µF ceramic capacitors at the input)

The power module should be connected to a low ac-impedance input source. Highly inductive source impedances can affect the stability of the module. An input capacitance must be placed close to the modules input pins to filter ripple current and ensure module stability in the presence of inductive traces that supply the input voltage to the module.

## DESIGN CONSIDERATIONS

### Remote On/Off

The IPM series power modules have an On/Off control pin for output voltage remote On/Off operation. The On/Off pin is an open collector/drain logic input signal that is referenced to ground. When On/Off control pin is not used, leave the pin unconnected.

The remote on/off pin is internally connected to +5Vdc through an internal pull-up resistor. Figure 27 shows the circuit configuration for applying the remote on/off pin. The module will execute a soft start ON when the transistor Q1 is in the off state.

The typical rise for this remote on/off pin at the output voltage of 2.5V and 5.0V are shown in Figure 17 and 18.

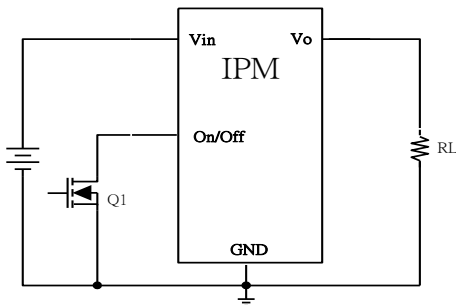

Figure 27: Remote on/off implementation

## FEATURES DESCRIPTIONS

### Over-Current Protection

To provide protection in an output over load fault condition, the unit is equipped with internal over-current protection. When the over-current protection is triggered, the unit enters hiccup mode. The units operate normally once the fault condition is removed.

### Output Voltage Programming

The output voltage shall be externally adjustable by use of a Trim pin. The module output shall be adjusted by either a voltage source referenced to ground or an external resistor be connected between trim pin and Vo or ground. To trim-down using an external resistor, connect a resistor between the Trim and Vo pin of the module. To trim-up using an external resistor, connect a resistor between the Trim and ground pin of the module. The value of resistor is defined as is defined below. The module outputs shall not be adversely affected (regulation and operation) when the Trim pin is left open.

Trim up

$$R_{trim} = \frac{(V_{out}-0.7)*7.5}{V_{adj}-V_{out}} \quad (K\Omega)$$

Trim Down

$$R_{trim} = \frac{(V_{adj}-0.7)*5.36}{V_{out}-V_{adj}} \quad - (K\Omega)$$

Rtrim is the external resistor in KΩ

Vadj is the desired output voltage

Vout is the output voltage without trim resistor

IPM can also be programmed by applying a voltage between the TRIM and GND pins (Figure 31). The following equation can be used to determine the value of Vtrim needed for a desired output voltage Vo:



## FEATURES DESCRIPTIONS (CON.)

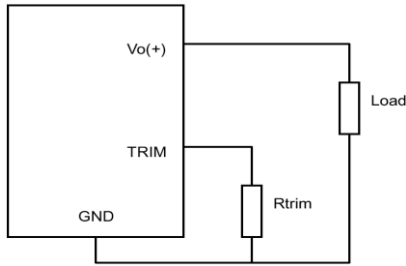

**Figure 29:** Trim up Circuit configuration for programming output voltage using an external resistor

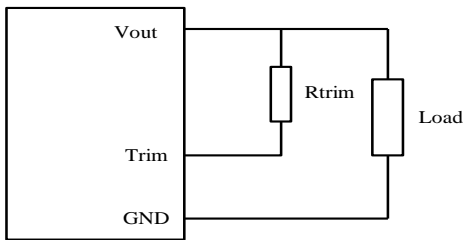

**Figure 30:** Trim down Circuit configuration for programming output voltage using an external resistor

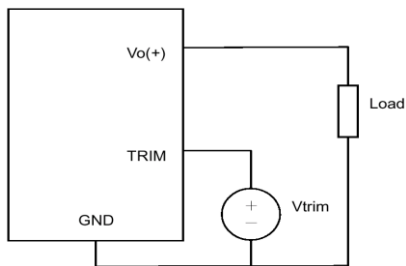

**Figure 31:** Circuit configuration for programming output voltage using external voltage source

Table 1 provides Rtrim values required for some common output voltages. By using a 0.5% tolerance resistor, set point tolerance of  $\pm 2\%$  can be achieved as specified in the electrical specification.

Rtrim is the external resistor in K $\Omega$ ; Vadj is the desired output voltage

		Rtrim setting ( $\Omega$ )		Output Measurement
		R.trim_Up	R.trim_Down	0A
Vo	1.2	NC	NC	1.193
Vadj	1.5	12.4K	NC	1.494
Vadj	1.8	6.19K	NC	1.793
Vadj	2.5	2.87K	NC	2.490

The amount of power delivered by the module is the voltage at the output terminals multiplied by the output current. When using the trim feature, the output voltage of the module can be increased, which at the same output current would increase the power output of the module. Care should be taken to ensure that the maximum output power of the module must not exceed the maximum rated power ( $V_{o.set} \times I_{o.max} \leq P_{max}$ ).

## Voltage Margining

Output voltage margining can be implemented in the IPM modules by connecting a resistor,  $R_{margin-up}$ , from the Trim pin to the ground pin for margining-up the output voltage and by connecting a resistor,  $R_{margin-down}$ , from the Trim pin to the output pin for margining-down. Figure 32 shows the circuit configuration for output voltage margining. If unused, leave the trim pin unconnected.

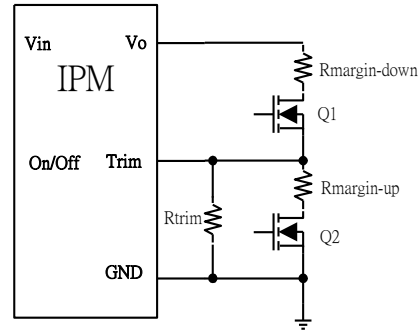

**Figure 32:** Circuit configuration for output voltage margining

## THERMAL CONSIDERATIONS

Thermal management is an important part of the system design. To ensure proper, reliable operation, sufficient cooling of the power module is needed over the entire temperature range of the module. Convection cooling is usually the dominant mode of heat transfer.

Hence, the choice of equipment to characterize the thermal performance of the power module is a wind tunnel.

### Thermal Testing Setup

Delta's DC/DC power modules are characterized in heated vertical wind tunnels that simulate the thermal environments encountered in most electronics equipment. This type of equipment commonly uses vertically mounted circuit cards in cabinet racks in which the power modules are mounted.

The following figure shows the wind tunnel characterization setup. The power module is mounted on a test PWB and is vertically positioned within the wind tunnel. The height of this fan duct is constantly kept at 25.4mm (1").

### Thermal Derating

Heat can be removed by increasing airflow over the module. To enhance system reliability, the power module should always be operated below the maximum operating temperature. If the temperature exceeds the maximum module temperature, reliability of the unit may be affected.

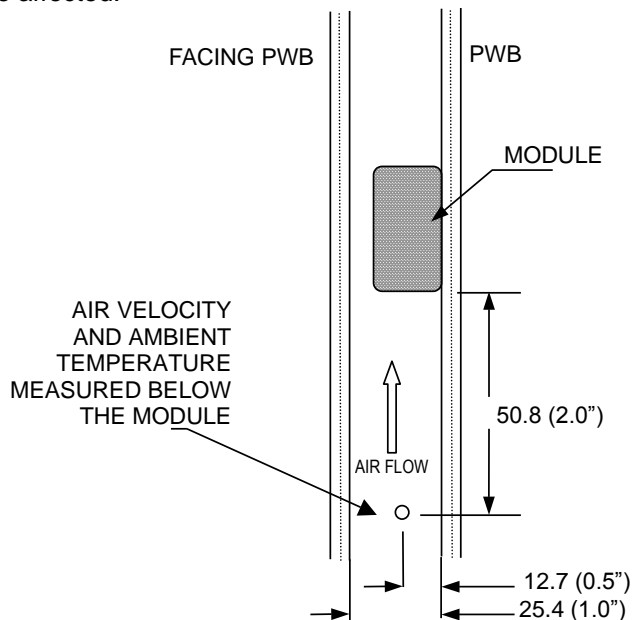

**Figure 32:** Wind tunnel test setup figure dimensions are in millimeters and (inches)



# THERMAL CURVES

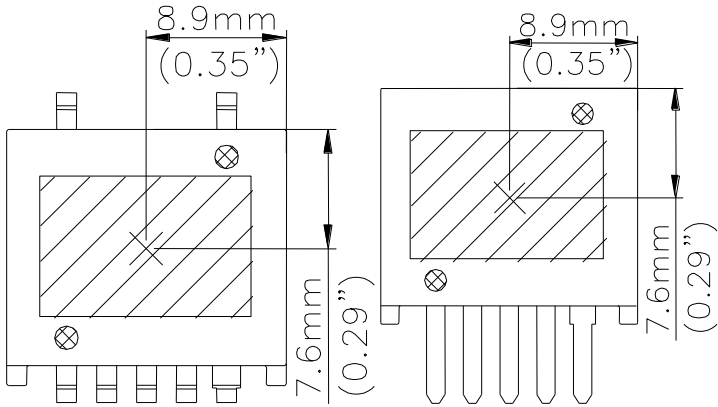

**Figure 33: Temperature measurement location**  
 \* The allowed maximum hot spot temperature is defined at 125 °C.

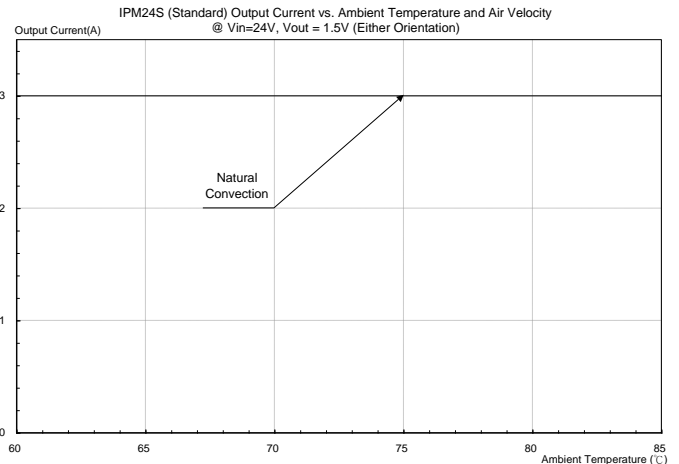

**Figure 36: Output current vs. ambient temperature and air velocity**  
 @Vin=24V, Vout=1.5V(Either Orientation)

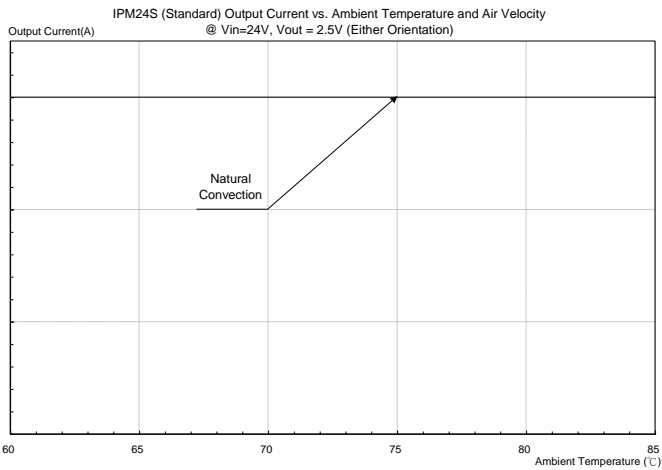

**Figure 34: Output current vs. ambient temperature and air velocity**  
 @Vin=24V, Vout=2.5V(Either Orientation)

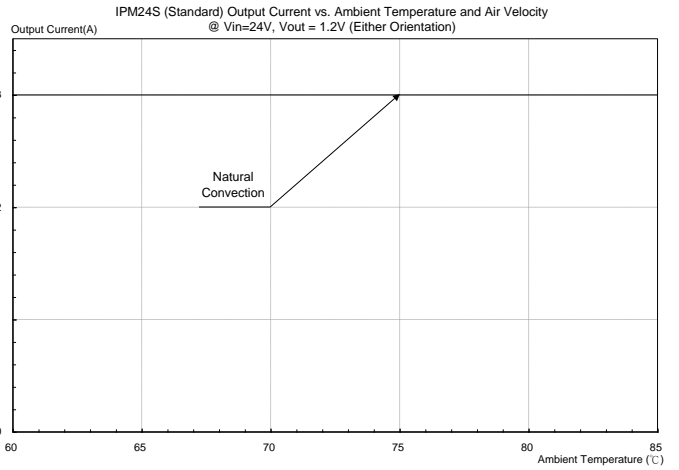

**Figure 37: Output current vs. ambient temperature and air velocity**  
 @Vin=24V, Vout=1.2V(Either Orientation)

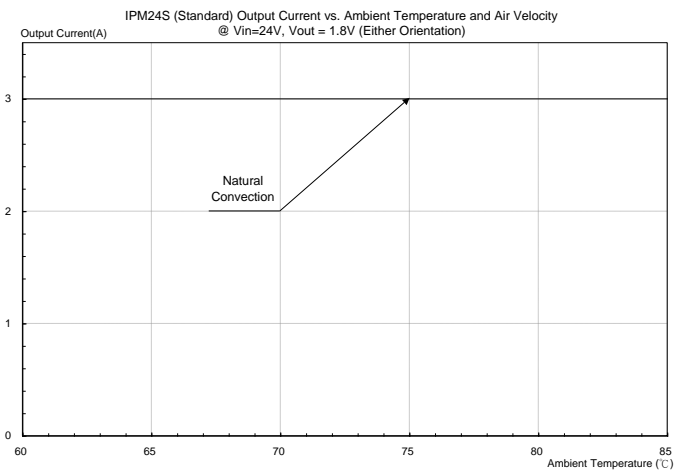

**Figure 35: Output current vs. ambient temperature and air velocity**  
 @Vin=24V, Vout=1.8V(Either Orientation)



## PICK AND PLACE LOCATION

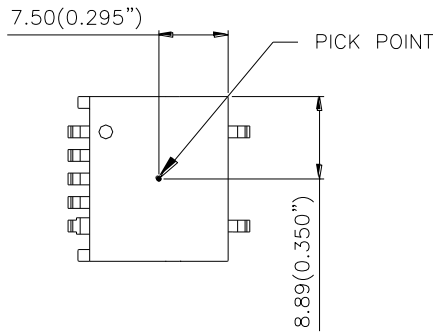

All dimensions are in millimeters (inches)

## SURFACE-MOUNT TAPE & REEL

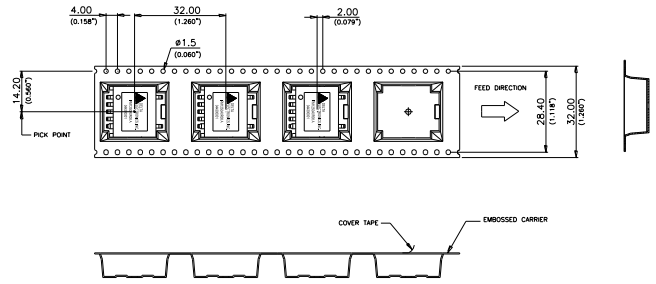

All dimensions are in millimeters (inches)

## LEAD FREE PROCESS RECOMMEND TEMP. PROFILE

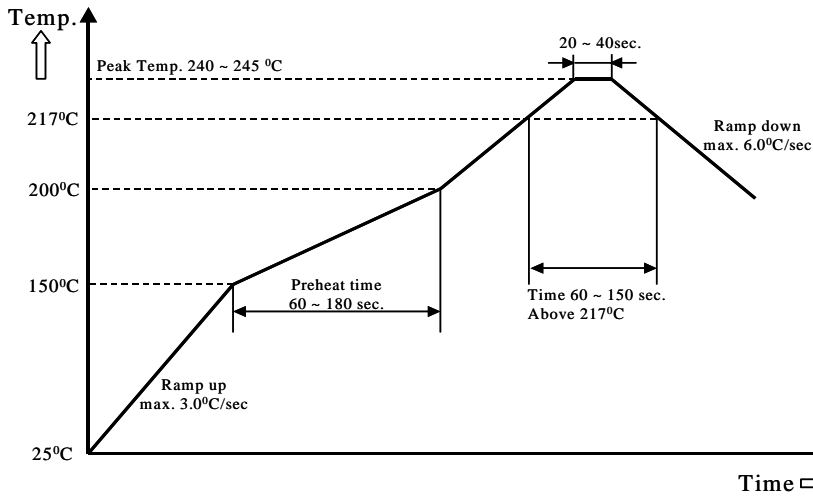

Note: All temperature refers to topside of the package, measured on the package body surface.

# MECHANICAL DRAWING

## SMD PACKAGE

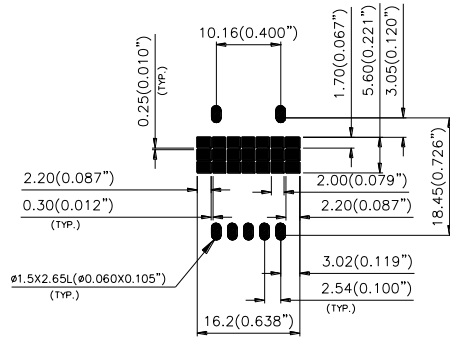
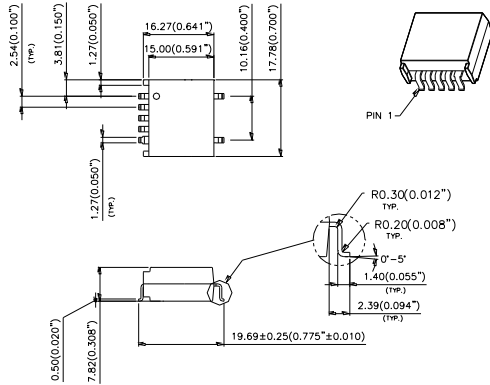

RECOMMEND PWB PAD LAYOUT

## SIP PACKAGE

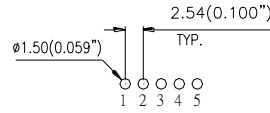
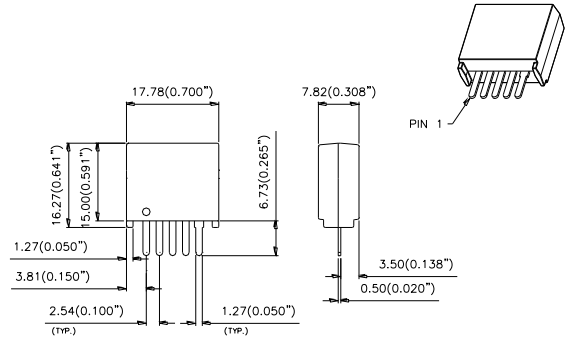

RECOMMEND PWB HOLE LAYOUT

**Note: The copper pad is recommended to connect to the ground.**

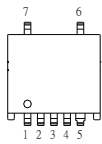

Pin#	Function
1	Remote on/off
2	+Vin
3	Ground
4	+Vo
5	Trim
6	No connection
7	No connection

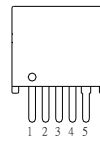

Pin#	Function
1	Remote on/off
2	+Vin
3	Ground
4	+Vo
5	Trim

**Note: All dimension are in millimeters (inches) standard dimension tolerance is  $\pm 0.10(0.004")$**

## PART NUMBERING SYSTEM

IPM	24	S	0A0	S	03	F	A
Product Family	Input Voltage	Number of Outputs	Output Voltage	Package	Output Current		Option Code
Integrated POL Module	8V~36V	S - Single	0A0 - programmable output 1.2~2.5V	R - SIP S - SMD	03 - 3A	F- RoHS 6/6 (Lead Free)	A - Standard Function

## MODEL LIST

Model Name	Input Voltage	Output Voltage	Output Current	Efficiency (Full load@12Vin)
IPM24S0A0S/R03FA	8V ~ 36V	1.2V ~ 2.5V	3A	85%
IPM24S0B0S/R03FA	11V ~ 36V	3.3V ~ 6.5V	3A	91%
Model Name	Input Voltage	Output Voltage	Output Current	Efficiency (Full load@20Vin)
IPM24S0C0S/R03FA	20V ~ 36V	8.0V~15.0V	3A	95%

### CONTACT: [www.deltaww.com/dcdc](http://www.deltaww.com/dcdc)

#### USA:

Telephone:  
East Coast: 978-656-3993  
West Coast: 510-668-5100  
Fax: (978) 656 3964  
Email: [DCDC@delta-corp.com](mailto:DCDC@delta-corp.com)

#### Europe:

Telephone: +31-20-655-0967  
Fax: +31-20-655-0999  
Email: [DCDC@delta-es.com](mailto:DCDC@delta-es.com)

#### Asia & the rest of world:

Telephone: +886 3 4526107 x6220~6224  
Fax: +886 3 4513485  
Email: [DCDC@delta.com.tw](mailto:DCDC@delta.com.tw)

## WARRANTY

Delta offers a two (2) year limited warranty. Complete warranty information is listed on our web site or is available upon request from Delta.

Information furnished by Delta is believed to be accurate and reliable. However, no responsibility is assumed by Delta for its use, nor for any infringements of patents or other rights of third parties, which may result from its use. No license is granted by implication or otherwise under any patent or patent rights of Delta. Delta reserves the right to revise these specifications at any time, without notice.

## X-ON Electronics

Largest Supplier of Electrical and Electronic Components

*Click to view similar products for [Non-Isolated DC/DC Converters](#) category:*

*Click to view products by [Delta](#) manufacturer:*

Other Similar products are found below :

[BRFS50](#) [APTH003A0X-SRZ](#) [SPM1004-3V3C](#) [R-785.0-05](#) [BRFS30](#) [PJT020A0X43-SRZ](#) [10E24-P15-10PPM](#) [1E24-P4-25PPM-SHV-5KV](#)  
[CA-17205-L4](#) [4D15-N1](#) [MYGTM01210BZN](#) [APXW012A0X3-SRDZ](#) [10C24-N250-I10-AQ-DA](#) [4AA24-P20-M-H](#) [DX150N](#) [3V12-N0.8](#)  
[2HVA24-BP1-F-25PPM-SHV-5KV](#) [5HVA24-BP1-F-25PPM-SHV-5KV](#) [1/2AA24-P30-I10](#) [1C24-P20-M-C](#) [VI-920194B](#) [T31SN24005NMFA](#)  
[3V24-P1](#) [3V24-N1](#) [BMR4672010/001](#) [BMR4652010/001](#) [BMR4668004/001](#) [T31SN12008NMFA](#) [6AA24-P30-I5-M](#) [6AA24-N30-I5-M](#)  
[PTV03020WAH](#) [PTV05020WAH](#) [PTV12010LAH](#) [PTV12020WAD](#) [IBF05012A006V-007-R](#) [IBF12012A007V-007-R](#) [V7806-1500](#)  
[V7806W-500](#) [PTV12020LAH](#) [PTN04050CAZT](#) [PTH12020WAD](#) [I6A24008A033V-N00-R](#) [R-625.0D](#) [R-7212D](#) [R-7212P](#) [R-745.0D](#) [R-](#)  
[78AA15-0.5SMD](#) [R-78AA5.0-1.0SMD](#) [30A24-N15-E](#) [10A12-P4-M](#)