

LED Driver

LNE-150W Series / LNE-□V150W□□□



LNE

Highlights & Features

- North American and International AC voltage options
- Up to 94.0% efficiency
- 6kV common mode & 4kV differential mode surge immunity
- Active PFC. Meets IEC/EN 61000-3-2, Class C
- Adjustable voltage & current; dimming option available
- IP65 or IP67 assembly for indoor and outdoor applications

Safety Standards



CB Certified for worldwide use

Model Number: LNE-□V150W□□□
Unit Weight: 1.04 kg (2.29 lb)
Dimensions (L x W x D): 228 x 68 x 38.8 mm
 (8.98 x 2.68 x 1.53 inch)

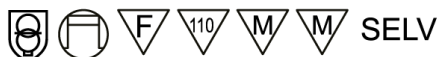

Package Type

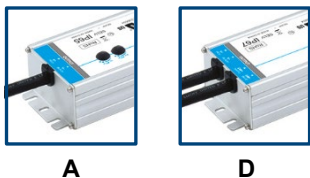

A

D

General Description

Delta LNE series of LED drivers comes with different combinations of features to suit different application requirements and energy optimization needs. Options include externally adjustable output voltage and current levels, and adjustment of LED brightness via 3-way built-in dimming function. All models in the LNE series come with a full corrosion resistant aluminum casing, major international safety certifications and are compliant with EN55015 immunity/Emissions/Harmonic requirements. The products are designed and rigorously tested to work in various indoor and outdoor LED lighting conditions. High surge immunity (common mode: 6kV, differential mode: 4kV), MTBF > 700,000hrs and compliance to IP65/IP67, all make the Delta LNE series an essential part of an energy efficient LED lighting power solution for both indoor and outdoor applications.

Model Information

LNE LED Driver

| Model Number | Input Voltage Range | Rated Output Voltage | Rated Output Current |
|----------------|--|----------------------|----------------------|
| LNE-12V150W□□□ | 90-305Vac (LNE-□V150W□A□) 90-264Vac (LNE-□V150W□C□) | 12Vdc | 12.50A |
| LNE-24V150W□□□ | | 24Vdc | 6.30A |
| LNE-36V150W□□□ | | 36Vdc | 4.20A |
| LNE-48V150W□□□ | | 48Vdc | 3.20A |
| LNE-54V150W□□□ | | 54Vdc | 2.80A |

Model Numbering

| LN | E - | □V | 150W | □ | □ | □ |
|------------|---|---|-------------------------------------|--|--|--------------------------------|
| LED Driver | Product Series E – High efficiency and PFC | Output Voltage 12V 24V 36V 48V 54V | Output Power (150W series model) | Package Type A – IP65 with potentiometers to adjust output voltage & constant current level D – IP67 with dimming cable to adjust constant current level | Safety Approval A – UL approval C – ENEC, CE, PSE and CCC approval | Variable A – Delta standard |

LED Driver

LNE-150W Series / LNE-□V150W□□□

Specifications

| Model Number | LNE-12V150W□ | LNE-24V150W□ | LNE-36V150W□ | LNE-48V150W□ | LNE-54V150W□ |
|--------------|--------------|--------------|--------------|--------------|--------------|
|--------------|--------------|--------------|--------------|--------------|--------------|

Input Ratings / Characteristics

| | | | | | | |
|---------------------------------|---|------------|------------|------------|------------|------------|
| Nominal Input Voltage | 100-277Vac (LNE-□V150W□A□) 100-240Vac (LNE-□V150W□C□) | | | | | |
| Input Voltage Range* | 90-305Vac (LNE-□V150W□A□) 90-264Vac (LNE-□V150W□C□) | | | | | |
| Nominal Input Frequency | 50-60Hz | | | | | |
| Input Frequency Range | 47-63Hz | | | | | |
| Input Current | 1.80A max. @ 115Vac, 0.85A max. @ 230Vac, 0.80A max. @ 277Vac | | | | | |
| Efficiency at 100% Load | 115Vac | 89.0% typ. | 91.5% typ. | 91.0% typ. | 91.5% typ. | 91.5% typ. |
| | 230Vac | 91.5% typ. | 93.0% typ. | 93.5% typ. | 94.0% typ. | 94.0% typ. |
| | 277Vac | 91.0% typ. | 93.0% typ. | 93.0% typ. | 94.0% typ. | 94.0% typ. |
| Max Inrush Current (Cold Start) | 65A typ. @ 230Vac | | | | | |
| Power Factor at 100% Load | 0.98 typ. @ 115Vac 0.95 typ. @ 230Vac 0.92 typ. @ 277Vac | | | | | |
| Total Harmonic Distortion | < 20% @ 115Vac/60 Hz & 230Vac/50 Hz (≥ 60% load) < 20% @ 277Vac/50 Hz (≥ 75% load) | | | | | |
| Leakage Current | < 0.75mA @ 305Vac (LNE-□V150W□A□) < 0.75mA @ 264Vac (LNE-□V150W□C□) | | | | | |

* Output power is de-rated at low input voltage. Please refer to Fig. 2 on page 10.

LED Driver

LNE-150W Series / LNE-□V150W□□□

Power Factor VS Output Load

LNE-12V150W□

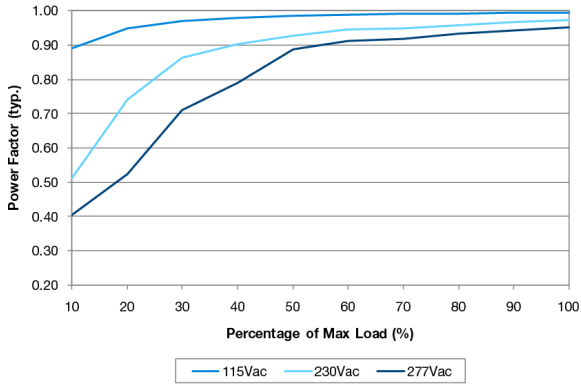

LNE-24V150W□

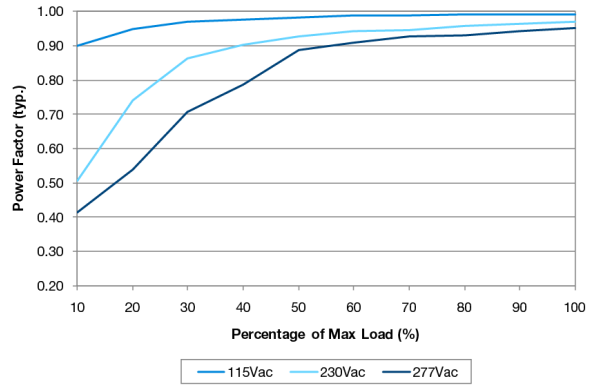

LNE-36V150W□

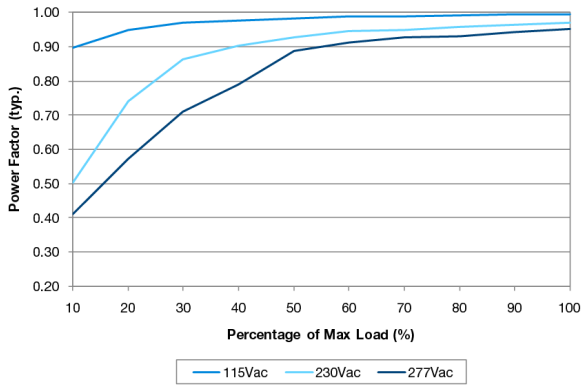

LNE-48V150W□

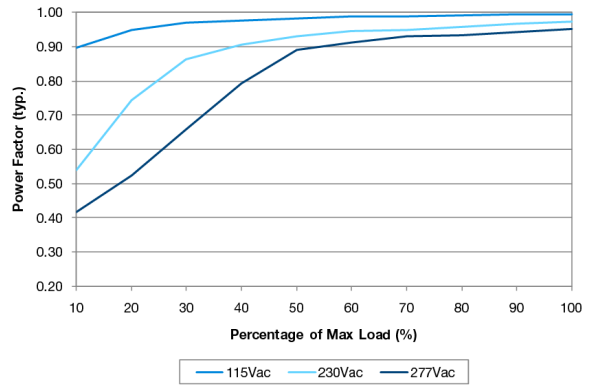

LNE-54V150W□

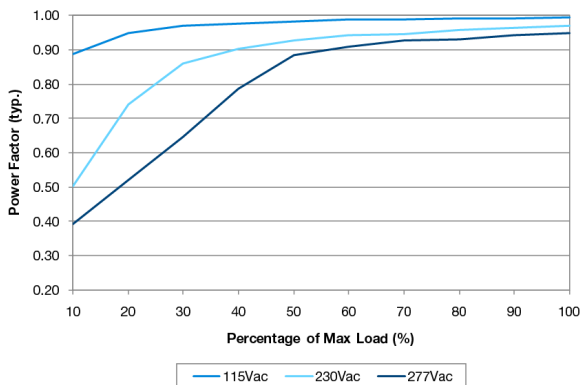

LED Driver

LNE-150W Series / LNE-□V150W□□□

Efficiency VS Output Load at Nominal Output Voltage

LNE-12V150W□

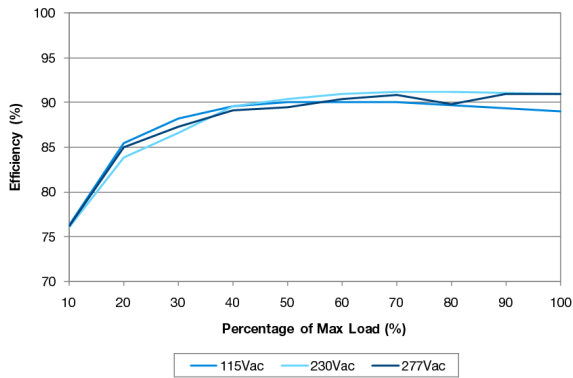

LNE-24V150W□

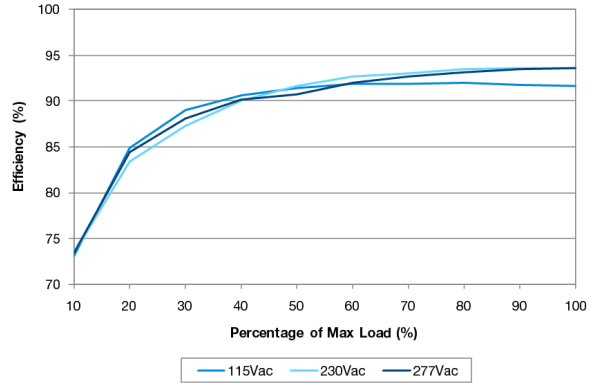

LNE-36V150W□

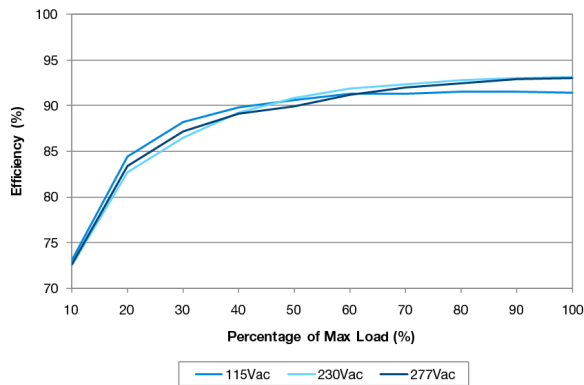

LNE-48V150W□

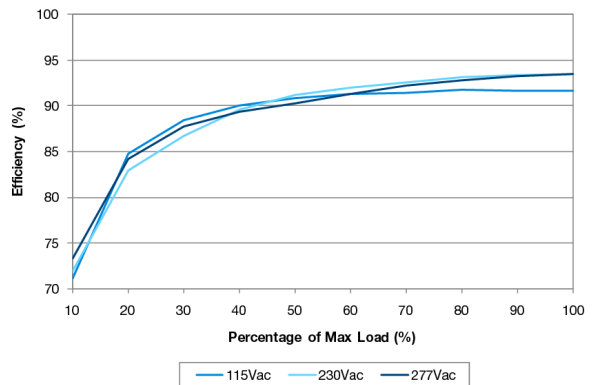

LNE-54V150W□

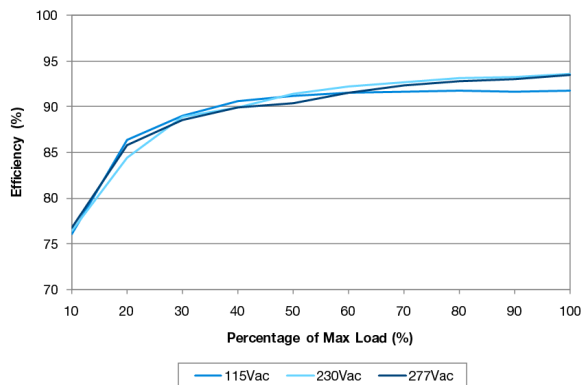

LED Driver

LNE-150W Series / LNE-□V150W□□□

| Model Number | LNE-12V150W□ | LNE-24V150W□ | LNE-36V150W□ | LNE-48V150W□ | LNE-54V150W□ |
|--------------|--------------|--------------|--------------|--------------|--------------|
|--------------|--------------|--------------|--------------|--------------|--------------|

Output Ratings / Characteristics*

| | | | | | |
|--|--|------------|------------|------------|------------|
| Nominal Output Voltage | 12Vdc | 24Vdc | 36Vdc | 48Vdc | 54Vdc |
| LED System Voltage Range in CC Mode | 6-12Vdc | 12-24Vdc | 18-36Vdc | 24-48Vdc | 27-54Vdc |
| Output Voltage Adjustment Range** | 10.8-13.5V | 22.0-27.0V | 33.0-40.0V | 43.0-53.0V | 49.0-58.0V |
| Nominal Output Current | 12.5A | 6.3A | 4.2A | 3.2A | 2.8A |
| Output Current Adjustment Range** | 6.25-12.50A | 3.15-6.30A | 2.10-4.20A | 1.60-3.20A | 1.40-2.80A |
| Output Power | 150W | 151.2W | 151.2W | 153.6W | 151.2W |
| Line Regulation @ 90-305Vac (LNE-□V150W□A□) @ 90-264Vac (LNE-□V150W□C□) | ± 0.5% | | | | |
| Load Regulation (0-95% load) @ 90-305Vac (LNE-□V150W□A□) @ 90-264Vac (LNE-□V150W□C□) | ± 2.0% | ± 1.0% | ± 1.0% | ± 0.5% | ± 0.5% |
| PARD*** (20MHz) | < 150mVpp | < 150mVpp | < 200mVpp | < 200mVpp | < 200mVpp |
| Rise Time | < 50ms @ 115Vac & 230Vac & 277Vac | | | | |
| Start-up Time | 1000ms typ. @ 115Vac (100% load) 500ms typ. @ 230Vac & 277Vac (100% load) | | | | |
| Hold-up Time | 16ms typ. @ 115Vac & 230Vac & 277Vac (100% load) | | | | |
| Dynamic Response (Overshoot & Undershoot O/P Voltage) | ± 5% @ 0-90% load, @ 115Vac & 230Vac & 277Vac (Slew Rate: 0.1A/μS) | | | | |

* For power de-rating from 60°C to 70°C, see power de-rating at Fig.1 on page 10.

** For LNE-□V150WA□□ package type only.

*** PARD is measured with an AC coupling mode, and in parallel with 0.1μF ceramic capacitor & 47μF electrolytic capacitor.

LED Driver

LNE-150W Series / LNE-□V150W□□□

| Model Number | LNE-12V150W□ | LNE-24V150W□ | LNE-36V150W□ | LNE-48V150W□ | LNE-54V150W□ |
|--------------|--------------|--------------|--------------|--------------|--------------|
|--------------|--------------|--------------|--------------|--------------|--------------|

Mechanical

| | | | | | |
|--------------------------------------|---------|--|-----------------------------|--|--|
| Casing | | Aluminium | | | |
| Dimensions (L x W x D) | | 228 x 68 x 38.8 mm (8.98 x 2.68 x 1.53 inch) | | | |
| Unit Weight | | 1.04 kg (2.29 lb) | | | |
| Cooling System | | Convection | | | |
| Wire | Input | LNE-□V150W□C□ | H05RN-F3G1.0mm ² | Line: Brown, Neutral: Blue, PE: Green/Yellow | |
| | | LNE-□V150W□A□ | SJTW 18AWGX3C | Line: Brown, Neutral: Blue, PE: Green/Yellow | |
| | Output | LNE-□V150W□C□ | H07RN-F2x1.5mm ² | Positive: Red, Negative: Black | |
| | | LNE-□V150W□A□ | SJTW 14AWGX2C | Positive: Red, Negative: Black | |
| | Dimming | LNE-□V150W□C□ | H05RN-F2x1.0mm ² | Positive: White, Negative: Blue | |
| | | LNE-□V150W□A□ | SJTW 18AWGX2C | Positive: White, Negative: Blue | |
| Noise (1 Meter from power supply) | | Sound Pressure Level (SPL) < 25dbA | | | |

Environment

| | | |
|--|---|--|
| Surrounding Air Temperature | Operating | -40°C to +70°C |
| | Storage | -40°C to +85°C |
| Power De-rating | > 60°C de-rate power by 4% / °C < 100Vac de-rate power by 2% / Vac | |
| Operating Humidity | 5 to 95% RH (Non-Condensing) | |
| Operating Altitude | 0 to 3,000 Meters (9,840 ft.) | |
| Shock Test | Non-Operating | IEC 60068-2-27, Half Sine Wave: 50G for a duration of 11ms, 3 shocks for each 3 directions |
| Vibration | Non-Operating | IEC 60068-2-6, Random: 5Hz to 500Hz (2.09G); 20 min per axis for all X, Y, Z direction |
| Pollution Degree | 2 | |
| Location Ratings (Included in safety approvals) | Dry rating (LNE-□V150WA□□) Dry, damp ratings (LNE-□V150WD□□) | |

Protections

| | | | | | |
|--------------------------|--|------------------------|------------------------|------------------------|------------------------|
| Overvoltage | 13.8-16.8V, Latch Mode | 27.6-33.6V, Latch Mode | 41.4-50.4V, Latch Mode | 55.2-67.2V, Latch Mode | 62.1-75.6V, Latch Mode |
| Overload / Overcurrent | 95-108% of rated load current, constant current limit Auto-Recovery when the fault is removed | | | | |
| Over Temperature | Hiccup Mode, Auto-Recovery when the fault is removed | | | | |
| Short Circuit | Constant current limit, Auto-Recovery when the fault is removed | | | | |
| Degree of Protection | IP65 (LNE-□V150WA□□) IP67 (LNE-□V150WD□□) | | | | |
| Protection Against Shock | Class I with PE* connection | | | | |

*PE: Primary Earth

LED Driver

LNE-150W Series / LNE-□V150W□□□

| Model Number | LNE-12V150W□ | LNE-24V150W□ | LNE-36V150W□ | LNE-48V150W□ | LNE-54V150W□ |
|--------------|--------------|--------------|--------------|--------------|--------------|
|--------------|--------------|--------------|--------------|--------------|--------------|

Reliability Data

| | |
|------------------------|---|
| MTBF | > 700,000 hrs. per Telcordia SR-332 at Input: 115Vac, Output: 100% load, Ta: 25°C |
| Expected Cap Life Time | 10 years (115Vac & 230Vac, 50% load @ 40°C) |

Safety Standards / Directives

| | | |
|--------------------|-------------------|---|
| Electrical Safety | CB scheme | LNE-□V150W□□□: IEC 61347-1, IEC 61347-2-13 |
| | ENEC | EN 61347-1, EN 61347-2-13, EN 62384 |
| | CCC | GB19510.1, GB19510.14 |
| | PSE | J61347-1, J61347-2-13 |
| | UL/cUL recognized | LNE-□V150W□A□: UL 8750 and CAN/CSA C22.2 No. 60950-1 |
| CE | | In conformance with EMC Directive 2014/30/EU and Low Voltage Directive 2014/35/EU (LNE-□V150W□□□) |
| Galvanic Isolation | Input to Output | 3.85kVac |
| | Input to Ground | 2.0kVac |
| | Output to Ground | 1.5kVac |

EMC

| | | |
|-----------------------------------|----------------|---|
| Emissions (CE & RE) | | CISPR 15, EN 55015, GB17743 Compliance to CISPR 32, EN 55032, FCC Title 47: Class B |
| Immunity | | EN 61547, Compliance to EN 55024 |
| Electrostatic Discharge | IEC 61000-4-2 | Level 4 Criteria B ²⁾ Air Discharge: 15kV Contact Discharge: 8kV |
| | | Level 3 Criteria A ¹⁾ Air Discharge: 8kV Contact Discharge: 6kV |
| Radiated Field | IEC 61000-4-3 | Level 3 Criteria A ¹⁾ 80MHz-1GHz, 10V/M with 1kHz tone / 80% modulation |
| Electrical Fast Transient / Burst | IEC 61000-4-4 | Level 3 Criteria A ¹⁾ 2kV |
| Surge | IEC 61000-4-5 | Level 5 Criteria B ²⁾ Common Mode ³⁾ : 6kV Differential Mode ⁴⁾ : 4kV |
| Conducted | IEC 61000-4-6 | Level 3 Criteria A ¹⁾ 150kHz-80MHz, 10Vrms |
| Power Frequency Magnetic Fields | IEC 61000-4-8 | Level 3 Criteria A ¹⁾ 10A/Meter |
| Voltage Dips | IEC 61000-4-11 | 100% dip, 0.5 cycle, Criteria A ¹⁾ 70% dip, 10 cycle, Criteria B ²⁾ @ 100Vac & Criteria A ¹⁾ @ 230Vac |
| Harmonic Current Emission | | IEC/EN 61000-3-2, Class C; GB17625.1 (THD conditions: 115Vac & 230Vac @ ≥ 60% load & 277Vac @ ≥ 75% load) |
| Voltage Fluctuation and Flicker | | IEC/EN 61000-3-3 |

1) Criteria A: Normal performance within the specification limits

2) Criteria B: Temporary degradation or loss of function which is self-recoverable

3) Asymmetrical: Common mode (Line to earth)

4) Symmetrical: Differential mode (Line to line)

LED Driver

LNE-150W Series / LNE-□V150W□□□

Block Diagram

LNE-□V150WA□□

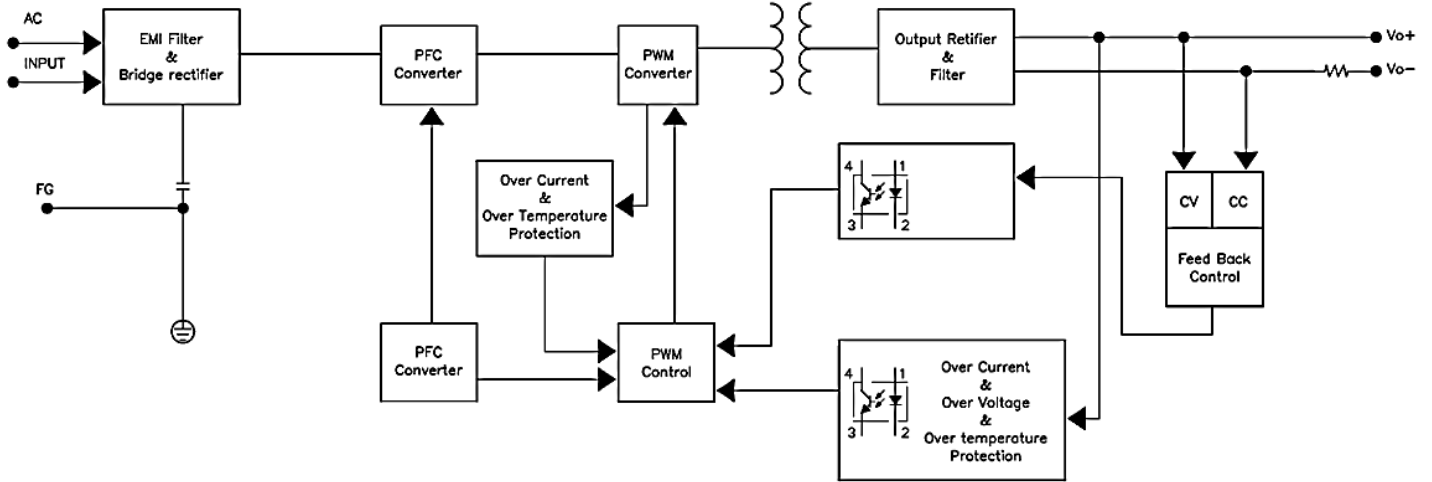

LNE-□V150WD□□

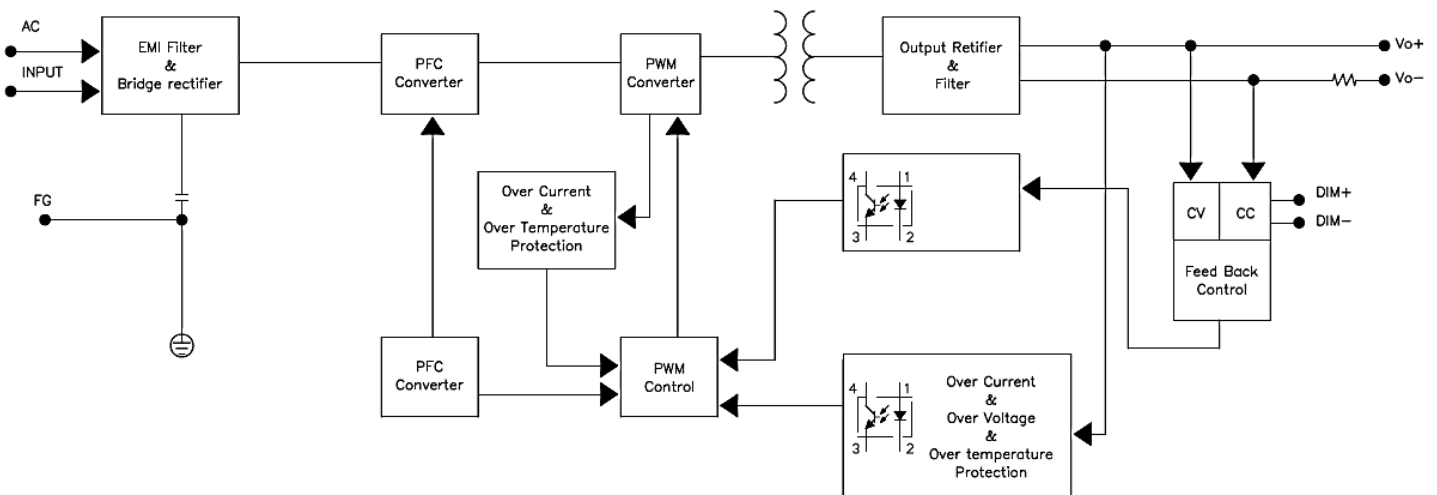

LED Driver

LNE-150W Series / LNE-□V150W□□□

Dimensions

L x W x D: 228 x 68 x 38.8 mm [8.98 x 2.68 x 1.53 inch]

LNE-□V150WA□□

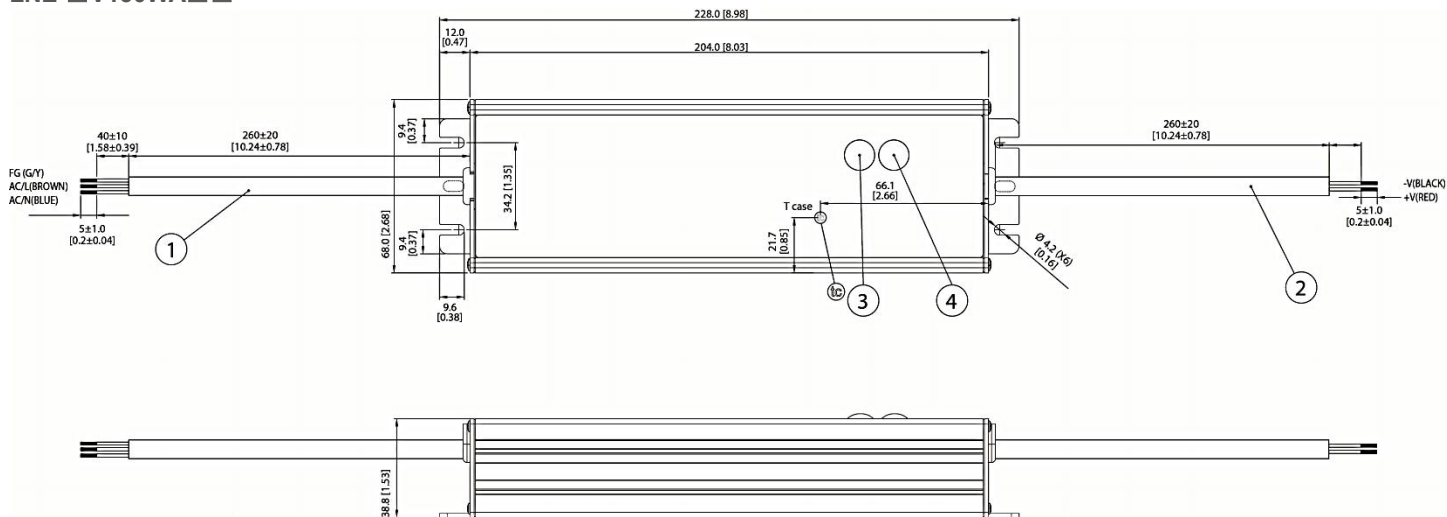

LNE-□V150WD□□

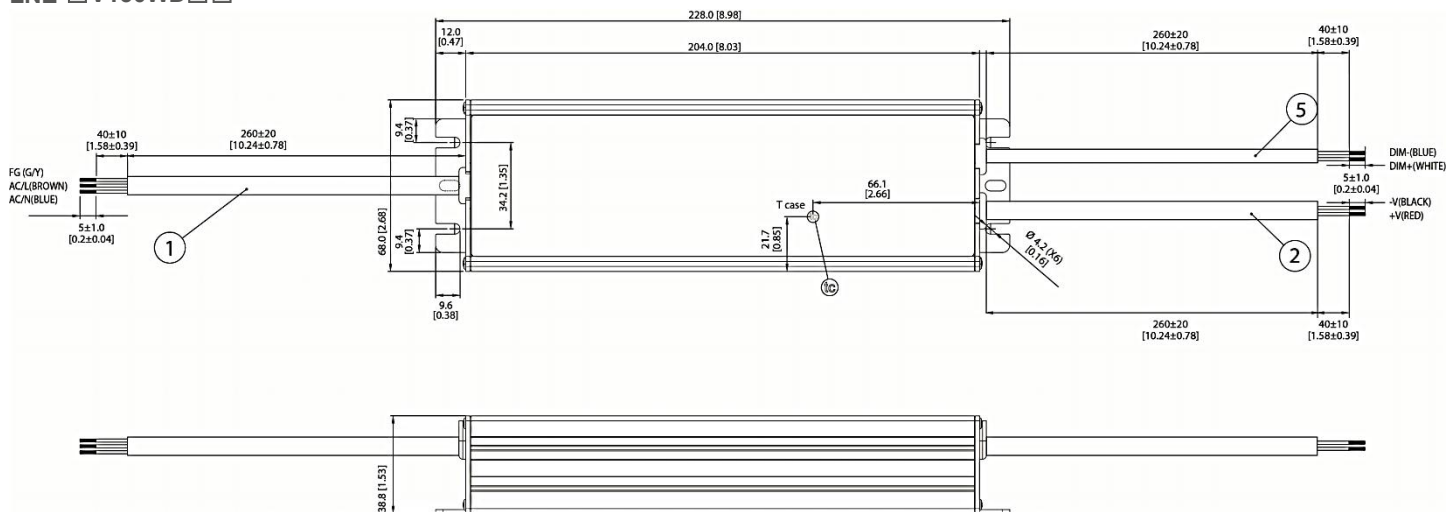

| Item | Device Description |
|------|---|
| 1 | Input cable |
| 2 | Output cable |
| 3 | Constant voltage adjustment potentiometer |
| 4 | Constant current adjustment potentiometer |
| 5 | Dimming Cable |
| tc | T case (tc): Temperature hot spot location on case. The temperature at this location will not exceed 85°C when used in accordance to conditions in this data sheet. |

LED Driver

LNE-150W Series / LNE-□V150W□□□

Engineering Data

Output Load De-rating VS Surrounding Air Temperature

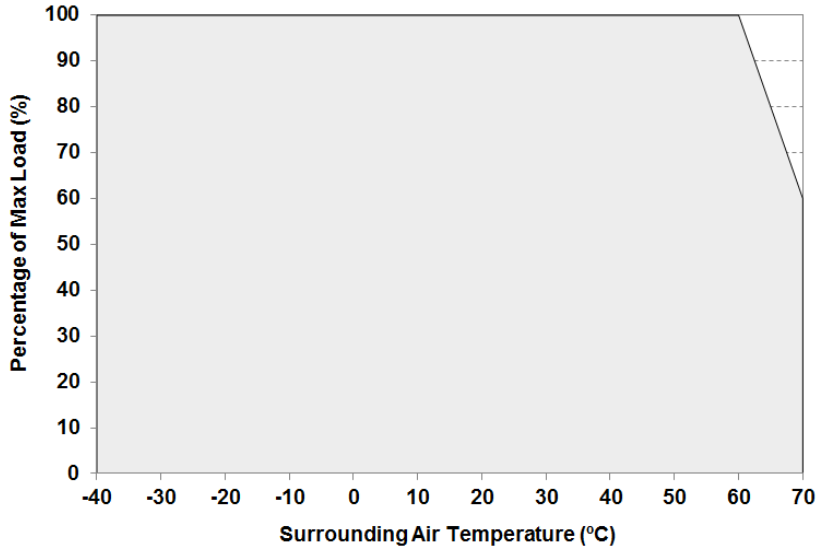

Fig. 1 De-rating for All Mounting Orientation (All Models)
 > 60°C de-rate power by 4% / °C

Note

1. Power supply components may degrade, or be damaged, when the power supply is continuously used outside the shaded region, refer to the graph shown in Fig. 1.
2. If the output capacity is not reduced when the surrounding air temperature >60°C, the device will run into Over Temperature Protection. When activated, the output voltage will go into bouncing mode and will recover when the surrounding air temperature is lowered or the load is reduced as far as necessary to keep the device in working condition.
3. Depending on the surrounding air temperature and output load delivered by the power supply, the device can be very hot!

Output Load De-rating VS Input Voltage

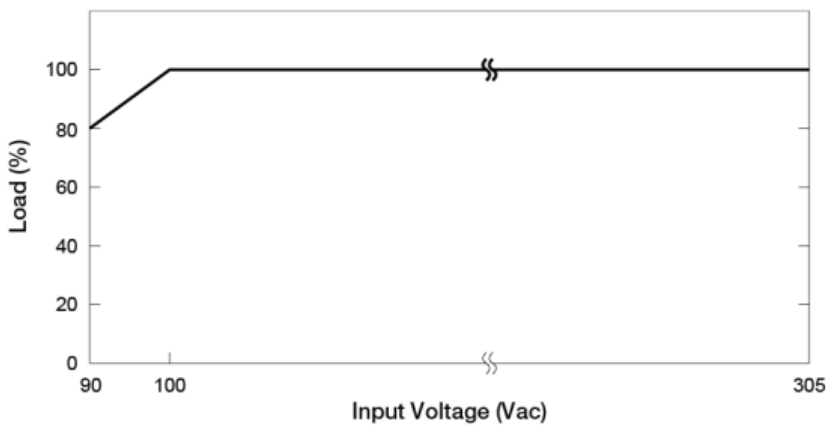

Fig. 2 De-rating for Low Input Voltage (All Models)
 < 100Vac de-rate power by 2% / Vac

- No output power de-rating for the input voltage from:-
 100Vac to 305Vac (LNE-□V150W□A□),
 100Vac to 264Vac (LNE-□V150W□C□)

LED Driver

LNE-150W Series / LNE-□V150W□□□

Assembly & Installation

Mounting holes for LED driver assembly onto the mounting surface.

| | |
|-------------|--|
| <p>Ⓐ, Ⓑ</p> | <p>Mounting holes for the LED driver (device). There are 3 mounting holes at either end of the device (locations Ⓐ and Ⓑ in Fig. 3). The device shall be mounted using a minimum of 2 out of the 3 mounting holes on both sides. Mounting shall be done using M4 screws with minimum length of 5mm. If customer's end system or panel where the device is mounted does not have screw threads, please use suitable metal screw and nut to secure the device.</p> |
| <p>Ⓒ</p> | <p>Surface Ⓒ belongs to customer's end product or panel where the device is mounted. The device should be mounted on a sturdy heat conducting surface with minimum of 4 mounting holes, as detailed above.</p> |

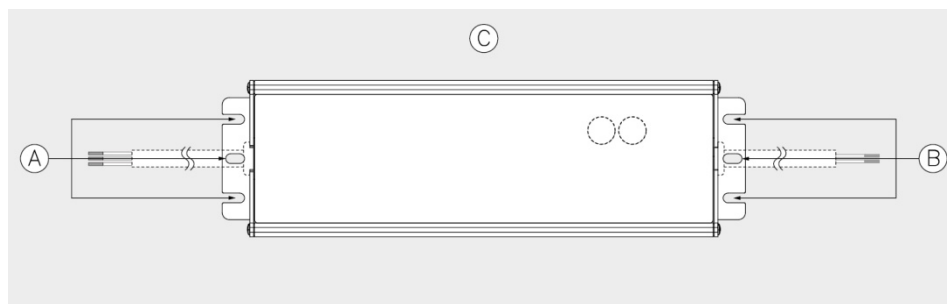

Fig. 3 Mounting Hole Locations

Safety Instructions

- ALWAYS switch mains of input power OFF before connecting and disconnecting the input voltage to the device. If mains are not turned OFF, there is risk of explosion / severe damage.
- To guarantee sufficient convection cooling, keep a distance of 50mm above and lateral distance to nearby objects.
- The device is not recommended to be placed on low thermal conductive surfaces. For example, plastics.
- DO NOT insert any objects into the device.
- Note that the enclosure of the device can become very hot depending on the surrounding air temperature and output load connected to the device. Risk of burns!
- If the device is continuously operating outside the shaded region shown in Fig. 1. The device may be damaged or degraded.
- When the PE (Green/Yellow) wire of the device is not connected, the device must be installed on a metal plate that has a PE connection.
- The current rating for the all wires, connected to the input and output wires of the device, must be rated higher than or equal to the input and output current of the power supply. Please refer to the product specifications.
- For device with dimming function, always ensure the dimming control is working properly.
- Please ensure the correct tools are used for all adjustments and installations of the device. If in doubt, please consult your local Delta support or contact us via info@DeltaPSU.com.

LED Driver

LNE-150W Series / LNE-□V150W□□□

Functions

Start-up Time

The time required for the output voltage to reach 90% of its final steady state set value, after the input voltage is applied.

Rise Time

The time required for the output voltage to change from 10% to 90% of its final steady state set value.

Hold-up Time

Time between the collapse of the AC input voltage, and the output falling to 95% of its steady state set value.

■ Graph illustrating the Start-up Time, Rise Time, and Hold-up Time

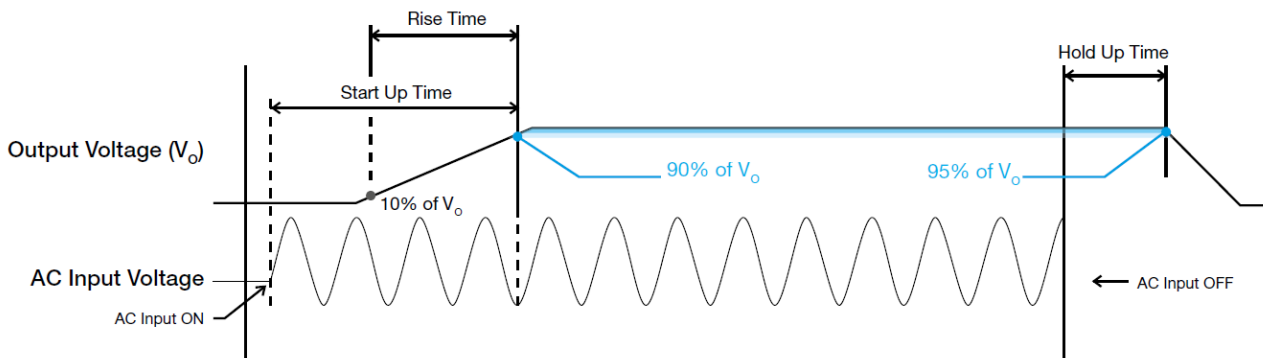

Inrush Current

Inrush current is the peak, instantaneous, input current measured and, occurs when the input voltage is first applied. For AC input voltages, the maximum peak value of inrush current will occur during the first half cycle of the applied AC voltage. This peak value decreases exponentially during subsequent cycles of AC voltage.

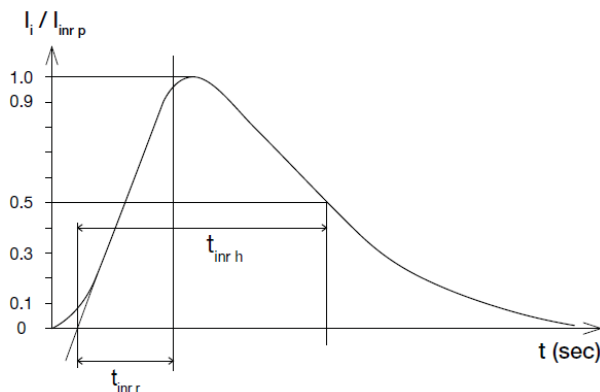

Dynamic Response (For CV Operation Only)

The power supply output voltage will remain within $\pm 5\%$ of its steady state value, when subjected to a dynamic load from 0 to 100% of its rated current.

■ 90% Duty / 1 KHz

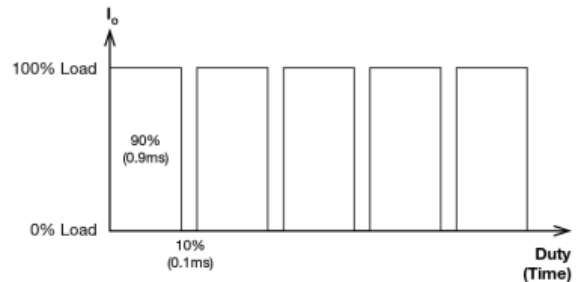

■ 90% Duty / 120 Hz

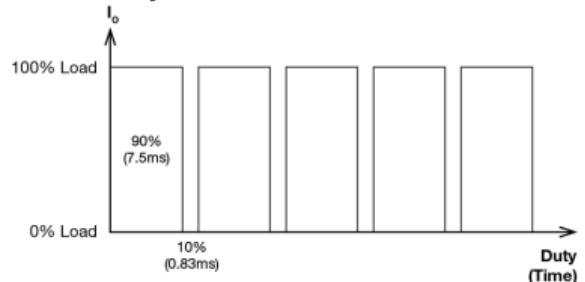

LED Driver

LNE-150W Series / LNE-□V150W□□□

Operating Methods of LED Modules-CV and CC Operation

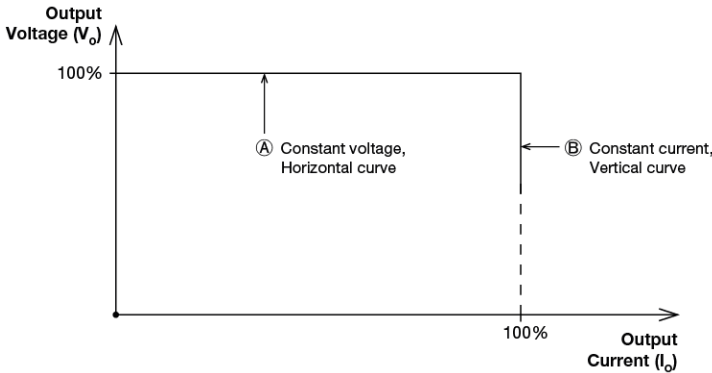

A typical LED power supply is able to either work in "constant voltage mode (CV) or constant current mode (CC)" to drive the LEDs. Delta's LNE drivers integrate CV+CC characteristics; so operation in CV mode (with external LED driver), in region (A) or CC mode (direct drive, at area (B)).

In the constant current region, the highest voltage at the output of the driver depends on the configuration of the end systems.

Should there be any compatibility issues or other questions with these adjustment methods, please contact with Delta.

Dimming Operations

This operation is available for LNE-□V150WD□□ only.

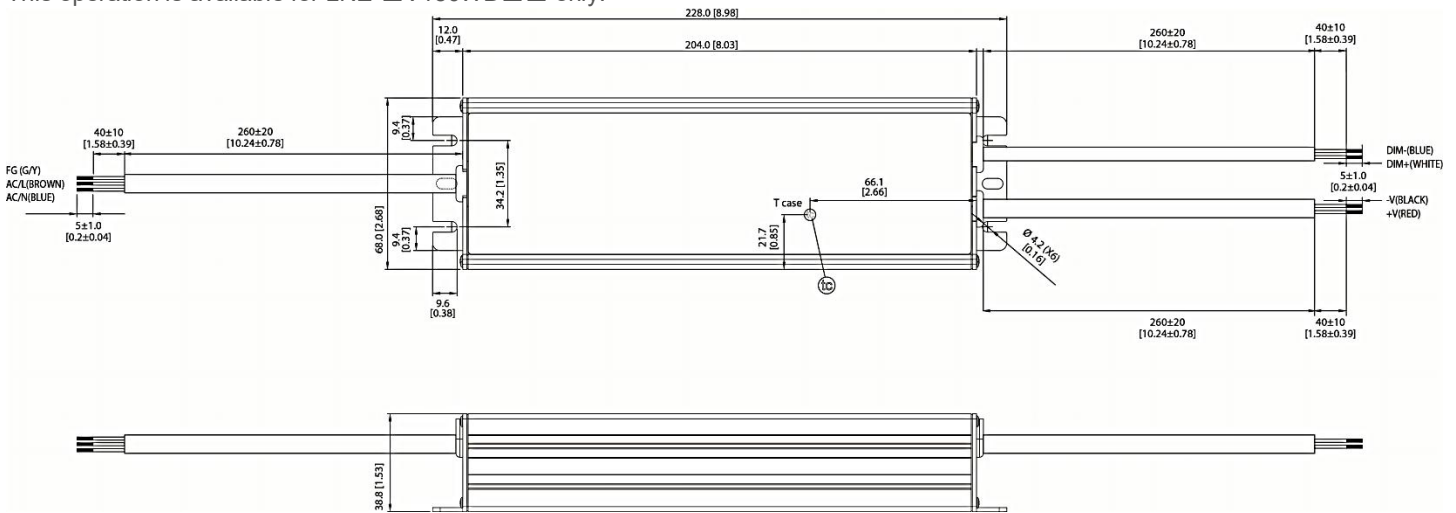

The Dimming connection diagram for turning the lighting fixture ON/OFF can be configured as below.

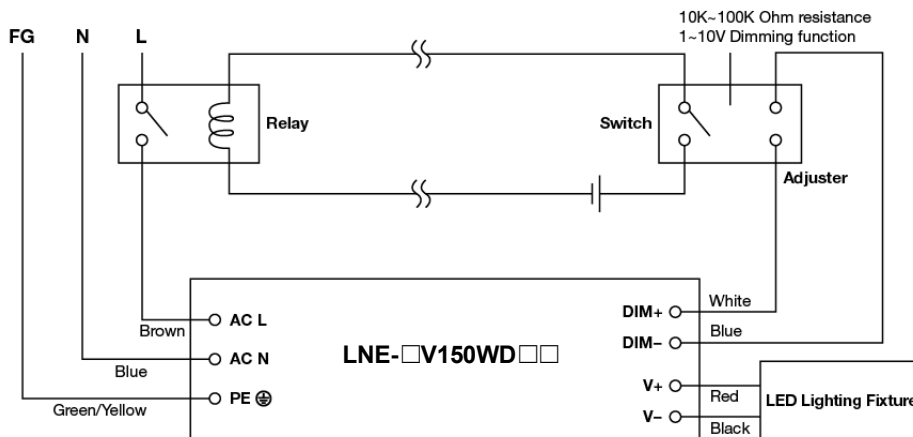

Please refer an example of reference configuration as follows.

1. Built-in 3 in 1 dimming function, IP67 rated. Output constant current level can be adjusted through output cable by connecting a resistance or 1~10Vdc or 10V PWM signal between DIM+ and DIM-.
2. The LED lighting fixture can be turned ON/OFF by the switch.

LED Driver

LNE-150W Series / LNE-□V150W□□□

3. Please DO NOT connect "DIM-" to "V-".
4. Reference resistance value for output current adjustment (Typical).

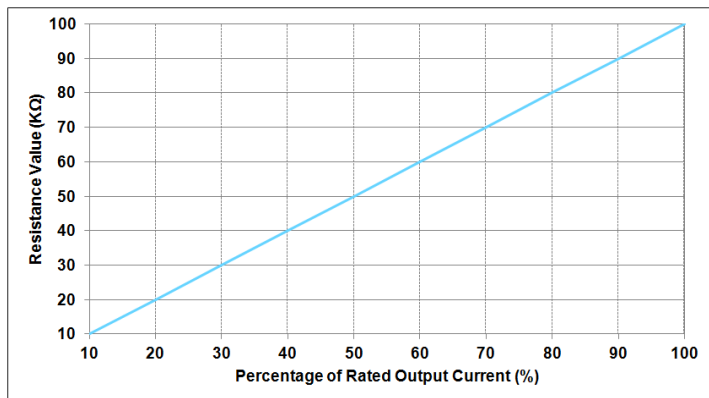

5. 1 ~ 10V dimming function for output current adjustment (Typical).

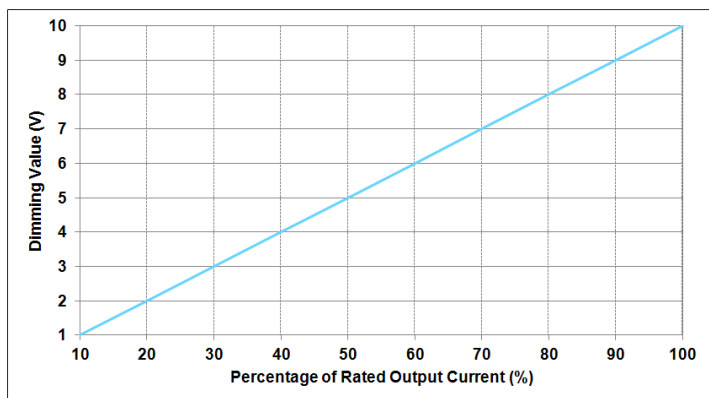

6. 10V PWM signal for output current adjustment is also possible. For additional information, please contact your Delta sales representative.
7. Please note that LNE-□V150WD□□ can't turn the lighting fixture completely off (totally dark) by using any of these dimming adjustment methods. To completely turn off the lighting fixture, the input AC voltage must be removed. See illustration on previous page.

External Input Protection Device

The unit is protected at the L pin, with an internal fuse that cannot be replaced. The power supply has been tested and approved on 20A branch circuits without additional protection device. An external protection device is only required if the supplying branch has an ampacity greater than above. Thus, if an external protective device is necessary, a 20 Ampere C-characteristic circuit breaker can be utilized.

LED Driver

LNE-150W Series / LNE-□V150W□□□

Overload & Overcurrent Protections (Auto-Recovery)

The power supply's Overload (OLP) and Overcurrent (OCP) Protections will be activated when output current is between 95% and 108% of I_O (Max load). Upon such an occurrence, the V_O (output voltage) will start to droop. Once the power supply has reached its maximum power limit, the protection will be activated; and, the power supply will operate in "CC mode". The power supply will recover once the fault condition once the cause of OLP or OCP is removed, and I_O is back within the specified range.

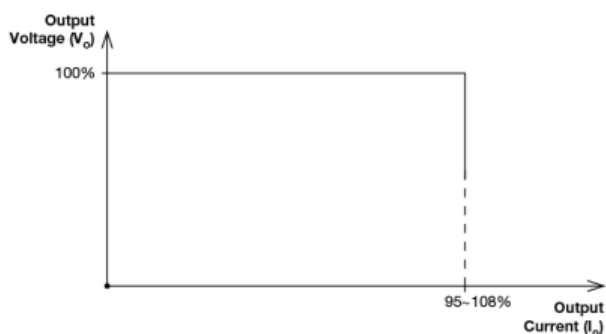

Short Circuit Protection (Auto-Recovery)

The power supply's output OLP/OCP function also provides protection against short circuits. When a short circuit is applied, the power supply will operate in "CC mode", as shown in the illustration in the OLP/OCP section on this page. The power supply will return to normal operation after the short circuit is removed.

Overvoltage Protection (Latch Mode)

The power supply's overvoltage circuit will be activated when its internal feedback circuit fails. The output voltage shall not exceed its specifications defined on Page 6 under "Protections". Power supply will latch off, and require removal/re-application of input AC voltage in order to restart.

The power supply should be latch.

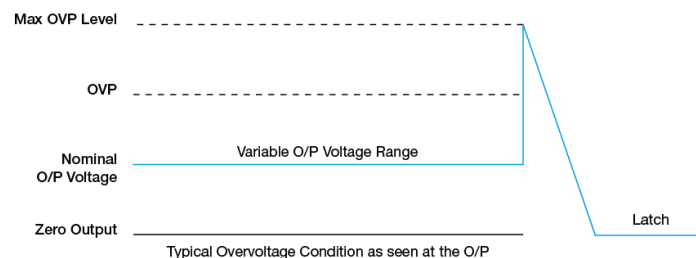

Over Temperature Protection (Auto-Recovery)

As mentioned above, the power supply also has Over Temperature Protection (OTP). In the event of a higher operating temperature at 100% load, the power supply will run into OTP when the operating temperature is beyond what is recommended in the de-rating graph. When activated, the output voltage will go into bouncing mode until the temperature drops to its normal operating temperature as recommended in the de-rating graph.

Others

PFC – Norm EN 61000-3-2

Line Current Harmonic content

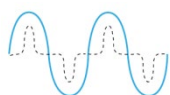

Typically, the input current waveform is not sinusoidal due to the periodical peak charging of the input capacitor. In industrial environment, complying with EN 61000-3-2 is only necessary under special conditions. Complying to this standard can have some technical drawbacks, such as lower efficiency as well as some commercial aspects such as higher purchasing costs. Frequently, the user does not profit from fulfilling this standard, therefore, it is important to know whether it is mandatory to meet this standard for a specific application.

Attention

Delta provides all information in the datasheets on an "AS IS" basis and does not offer any kind of warranty through the information for using the product. In the event of any discrepancy between the information in the catalog and datasheets, the datasheets shall prevail (please refer to www.DeltaPSU.com for the latest datasheets information). Delta shall have no liability of indemnification for any claim or action arising from any error for the provided information in the datasheets. Customer shall take its responsibility for evaluation of using the product before placing an order with Delta.

Delta reserves the right to make changes to the information described in the datasheets without notice.

X-ON Electronics

Largest Supplier of Electrical and Electronic Components

Click to view similar products for [LED Power Supplies](#) category:

Click to view products by [Delta](#) manufacturer:

Other Similar products are found below :

[ESS015W-1000-12](#) [PDA-WIFI](#) [PIFC-K250F](#) [PITB-K222A](#) [ALD-514012PJ134](#) [LB240S24KH](#) [LMH020-SPLC-0000-0000001](#) [79534](#) [79535](#)
[EUG-200S210DT](#) [ESS030W-1050-21](#) [ESS030W-0900-32](#) [BPOXL 4-12-035](#) [ESS010W-0350-24](#) [ESS010W-0200-42](#) [ESM060W-1400-42](#)
[PDA080B-1A0G](#) [ESS010W-0500-12](#) [PDA150B-S1A5G](#) [SLM140W-1.05-130-ZA](#) [ESS015W-0700-18](#) [EUD-150S350DVA](#) [LWA320-C420-](#)
[ARK-B](#) [HVG-240-48AB](#) [HVG-320-36AB](#) [HVG-320-54AB](#) [ELG-240-C1400AB](#) [EUK-150S105DV](#) [BXCS-12Z-N2P-B1-A](#) [BXPR-WN-01-A](#)
[LN1224CV](#) [BXCS-12D-N2P-01-A](#) [BXCS-12W-N2P-01-A](#) [HBG-160-24AB](#) [980100001200394](#) [980060001200376](#) [LC 14W 250-350MA](#)
[FLEXC R ADV2](#) [LC 24W 500-600MA FLEXC R ADV2](#) [LC 36W 850-900MA FLEXC R ADV2](#) [LC 50W 200-350ML 170V FLEXC LP](#)
[SNC4](#) [LC 25W 200-350ML 70V FLEXC LP SNC4](#) [LC 35W 200-350ML 121V FLEXC LP SNC4](#) [LCBI 10W 350MA PHASE-CUT/1-10V LP](#)
[LC 13W 300MA FIXC C SNC](#) [LC 10W 250MA FIXC SC SNC2](#) [LC 35W 800MA FIXC SR ADV2](#) [LC 38W 900MA FIXC SR ADV2](#) [LC](#)
[34W 800MA FIXC SC ADV2](#) [LC 44W 1050MA FIXC SC ADV2](#) [LC 38W 900MA 42V FIXC SRL ADV2](#)