

MDS Medical AC-DC Wall Mount Adapter

5Volt, 5Watt / MDS-005AAS05 B□



005AAS05 B□

Highlights & Features

- Meet Efficiency Level VI
- Safety Approvals to IEC 60601-1 3.1rd ed. & IEC 62368-1
- Compliant with IEC 60601-1-2 4th Ed. Requirements
- IP22 Ingress Protection Rating
- 1 Million Hours MTBF

Safety Standards



CB Certified for worldwide use

| | |
|--------------------------------|---|
| Model Number: | MDS-005AAS05 B□ |
| Unit Weight: | 100 grams (3.6 ounces) |
| Dimensions (W x L x H): | 39.5 x 56.5 x 28.0 mm (1.56 x 2.23 x 1.1 inch) |

General Description

The MDS series of external power supply come with universal AC input at 90Vac to 264Vac. Other features include low touch current, risk management report available and the electric shock protection comply with 2 x MOPP. The MDS series is certified for EMC standards according to EN 55011 for industrial, scientific and medical (ISM) radio-frequency equipment and EN 55032 for Information Technology Equipment (ITE) radio-frequency equipment.

The MDS series of external power supply come with both medical and ITE safety approvals including CE/CB certification and are fully compliant with RoHS Directive for environmental protection.

Model Information

Medical AC-DC Charger

| Model Number | Input Voltage Range | Output Voltage | Output Current |
|-----------------|---------------------|----------------|----------------|
| MDS-005AAS05 B□ | 90-264Vac | 5Vdc | 1A |

Model Numbering

| | | | | | |
|---|---|---|--|---|--|
| MDS <small>Delta Medical Power Supply</small> | - | 005 <small>Output Power* 005 → 5W</small> | AAS <small>Family Code</small> | 05 <small>Output Voltage Single Output: 05 for 5V</small> | B□ <small>Control Code BV : US Type with Barrel Type connector BU : US Type with Micro USB connector</small> |
|---|---|---|--|---|--|

* Maybe lower at some voltage.

MDS Medical AC-DC Wall Mount Adapter

5Volt, 5Watt / MDS-005AAS05 B□

Specifications

Input Ratings / Characteristics

| | |
|--------------------------|--|
| Nominal Input Voltage | 100-240Vac |
| Input Voltage Range | 90-264Vac |
| Nominal Input Frequency | 50-60Hz |
| Input Frequency Range | 47-63Hz |
| Input Current (max) | 0.2A @ 115Vac ; 0.1A @ 230Vac |
| Efficiency (typ.) | 71%, Reference Fig.1 |
| Average Efficiency (min) | 73.63% @ 115Vac and 230Vac |
| Standby Power (max) | 0.1W @ 115Vac and 230Vac |
| Inrush Current (typ.) | No component damage |
| Touch Current (max) | 0.1mA @ 264Vac NC ¹⁾ , 0.3mA @ 264Vac SFC ²⁾ |

1) NC: normal condition

2) SFC: single fault condition

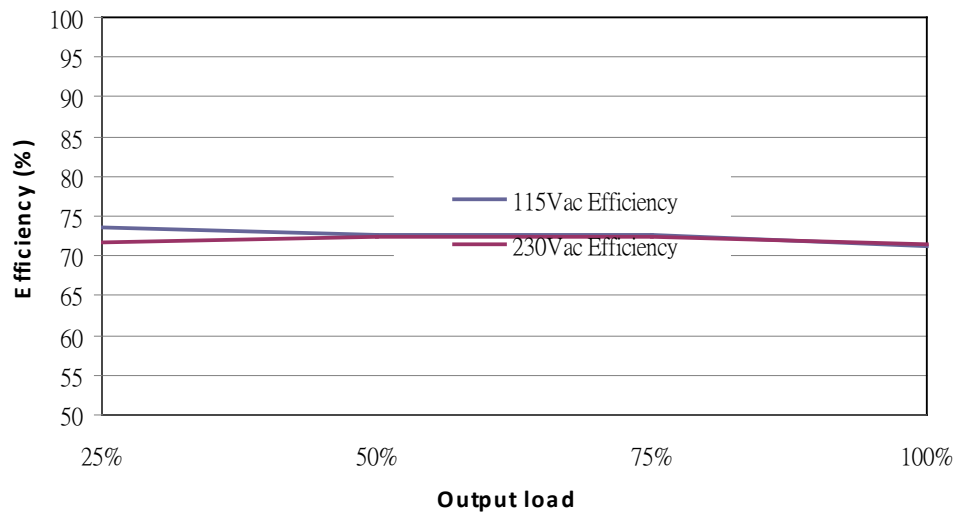

Fig.1 Efficiency versus output load

Output Ratings / Characteristics

| | |
|---|---|
| Nominal Output Voltage | 5Vdc |
| Total regulation | ±10% |
| Output Current | 1A |
| Output Power | 5W |
| Line Regulation (max) | ±1% |
| Load Regulation (max) | ±9% |
| Ripple & Noise (typ.) | 88mV pk-pk @ Full load, Reference Fig. 3 & 4 |
| Start-up Time(max) | 3000ms @ 115Vac |
| Hold-up Time(min) | 5ms @ 115Vac |
| Dynamic Response (Overshoot & Undershoot O/P Voltage) | ±10% @ 50-100% load (Slew Rate: 0.1A/μS, 50% duty cycle @ 1KHz) |

*Periodic and Random Deviation

MDS Medical AC-DC Wall Mount Adapter

5Volt, 5Watt / MDS-005AAS05 B□

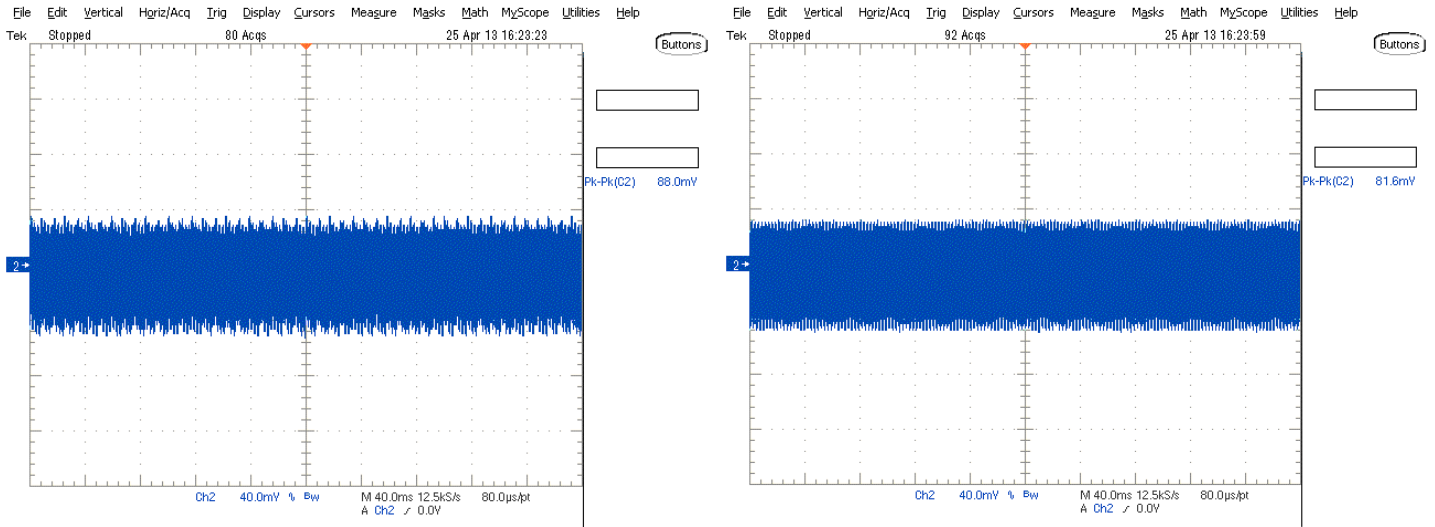

(a) 115V

(b) 230V

Fig. 2 Ripple & Noise example, 20MHz BW

Ripple & Noise measurement circuit

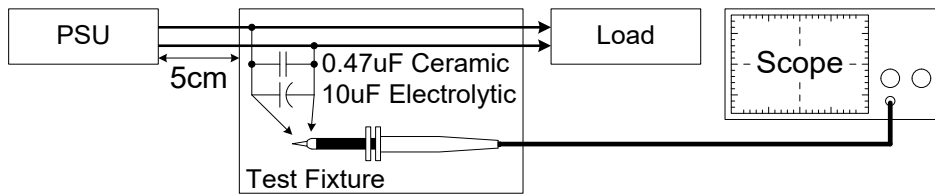

Mechanical

| | |
|----------------------|---|
| Case Chassis | PC |
| Case Cover | PC |
| Dimensions(W x Lx H) | 39.5 x 56.5 x 28.0 mm (1.56 x 2.23 x 1.1 inch) |
| Unit Weight | 100 grams (3.6 ounces) |
| Indicator | NA |
| Cooling System | NA |
| Terminal | Input: Wall mount - US Type Output: BV : Barrel type BU : Micro USB |

Environment

| | | |
|-----------------------------|-----------|--|
| Surrounding Air Temperature | Operating | 0°C to +40°C Linearly derate, at rate of 0.25 watts per degree C, from 5W at 40 degree C to 2.5W at 50 degree C |
| | Storage | -40°C to +85°C |
| Operating Humidity | | 5-95% RH (Non-Condensing) |
| Storage Humidity | | 5-95% RH (Non-Condensing) |
| Operating Altitude | | Up to 3,000 meters (up to 9,842 feet or 106-70kPa) |
| Shock Test (Non-Operating) | | 50G, 11ms, 3 shocks for each direction |
| Vibration (Operating) | | 5-500Hz, 2.09Grms, 20 minute for each three axis |

MDS Medical AC-DC Wall Mount Adapter

5Volt, 5Watt / MDS-005AAS05 B□

Protections

| | |
|--------------------------------|--|
| Over Voltage (max) | 150% of rated output voltage (Non-latch Mode) |
| Over Load / Over Current (max) | 130% of rated load current. (Non-Latching, Auto-Recovery) |
| Over Temperature | Hiccup Mode, (Non-Latching, Auto-Recovery) |
| Short Circuit | Hiccup Mode, (Non-Latching, Auto-Recovery) |
| Degree of Protection | IP22 |
| Protection Against Shock | Class II |

*PE: Protective Earth

Reliability Data

| | |
|---|--|
| MTBF(Minimum) at 100Vac, 5W, 25 °C | 1 Million Hours based on Telecordia SR-332 |
| Operating life(Minimum) at 100Vac, 5W, 25°C | 26,280 hrs |

Safety Standards / Directives

| | | |
|--------------------|--|------------------------------------|
| Medical Safety | IEC60601-1 3rd and 3.1rd editions CB reports IEC60601-1 edition 3.1rd (2012), EN60601-1 (2006) + A11 + A1 + A12, CAN/CSA-C22.2 NO. 60601-1:14, ANSI/AAMI ES60601-1:2005/(R)2012 | |
| ITE Safety | MDS-005AAS05 BV/BU | IEC60950-1 (Ed.2,2005), IEC62368-1 |
| | MDS-005AAS05 BU | BSMI, J60950-1 (H26) |
| CE | MDD Directive 93/42/EEC | |
| Galvanic Isolation | Input to Output | 4000 Vac |

MDS Medical AC-DC Wall Mount Adapter

5Volt, 5Watt / MDS-005AAS05 B□

EMC (Compliant with IEC 60601-1-2 4th Ed. Requirements)

| | | |
|-----------------------------------|---------------|---|
| EMC / Emissions | | EN 55011 & EN55032, FCC Title 47 Class B |
| Harmonic Current Emissions | IEC61000-3-2 | |
| Immunity to | | |
| Voltage Flicker | IEC61000-3-3 | |
| Electrostatic Discharge | IEC61000-4-2 | Level 4 Criteria A ¹⁾ Air Discharge: 15kV Contact Discharge: 8kV |
| Radiated Field | IEC61000-4-3 | Criteria A ¹⁾ 80MHz-2700MHz, 10V/m AM modulation 385MHz-5785MHz, 28V/m Pulse mode and other modulation |
| Electrical Fast Transient / Burst | IEC61000-4-4 | Level 3 Criteria A ¹⁾ : 2kV |
| Surge | IEC61000-4-5 | Level 3 Criteria A ¹⁾ Differential Mode ³⁾ : 1kV |
| Conducted | IEC61000-4-6 | Level 2 Criteria A ¹⁾ 150kHz-80MHz, 3Vrms, 6Vrms at ISM bands and Amateur radio bands |
| Power Frequency Magnetic Fields | IEC61000-4-8 | Criteria A ¹⁾ Magnetic field strength 30A/m |
| Voltage Dips | IEC61000-4-11 | Criteria B ²⁾ 0% U _r , 0.5 cycle (10ms) , 0°/45°/90°/135°/180°/225°/270°/315°/360° Criteria B ²⁾ 0% U _r , 1 cycle (20ms), 0° Criteria A ¹⁾ 70% U _r , 25 cycle (500ms), 0° Criteria B ²⁾ 0% U _r , 250 cycle (5000ms), 0° |

1) Criteria A: Normal performance within the specification limits

2) Criteria B: Output out of regulation, or shuts down during test. Automatically restore to normal operation after test.

3) Symmetrical: Differential mode (Line to line)

MDS Medical AC-DC Wall Mount Adapter

5Volt, 5Watt / MDS-005AAS05 B□

Block Diagram

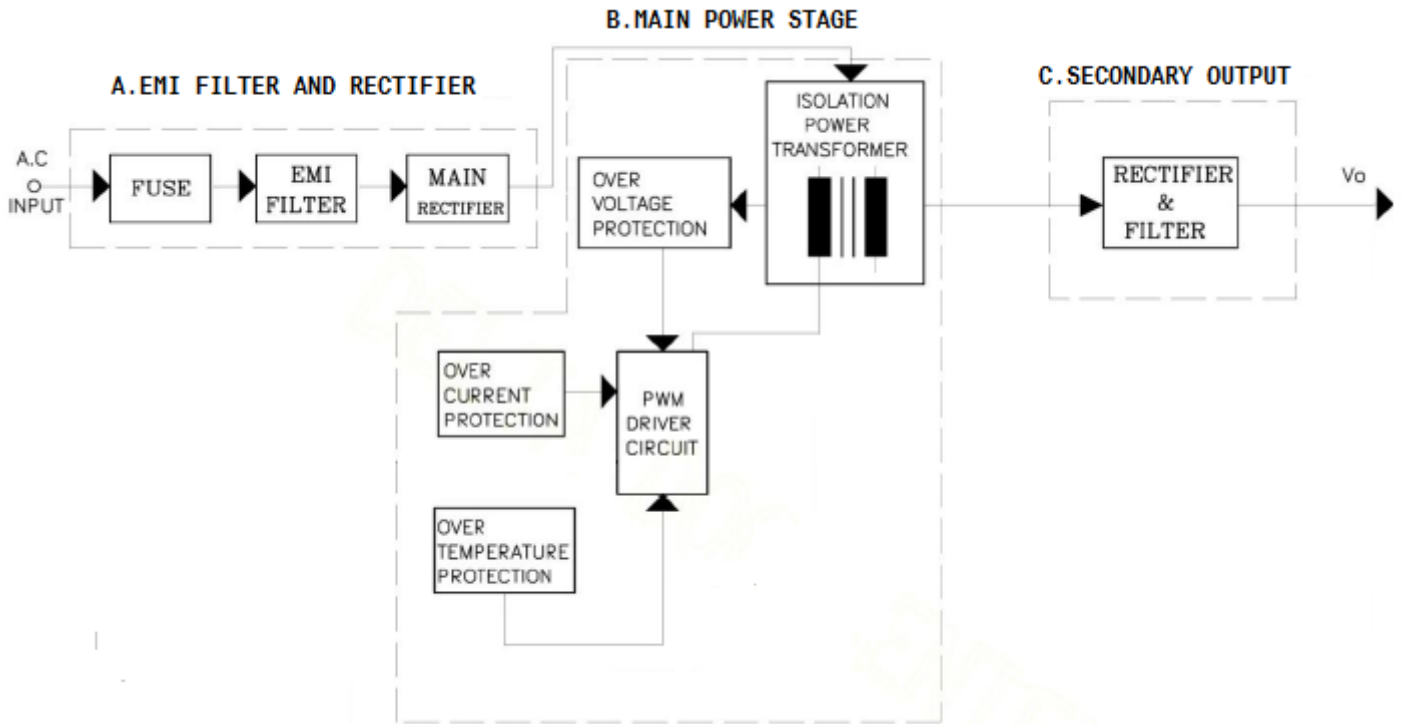

MDS Medical AC-DC Wall Mount Adapter

5Volt, 5Watt / MDS-005AAS05 B□

Dimensions

W x L x H: 39.5 x 56.5 x 28.0 mm (1.56 x 2.23 x 1.1 inch)

MDS-005AAS05 BV

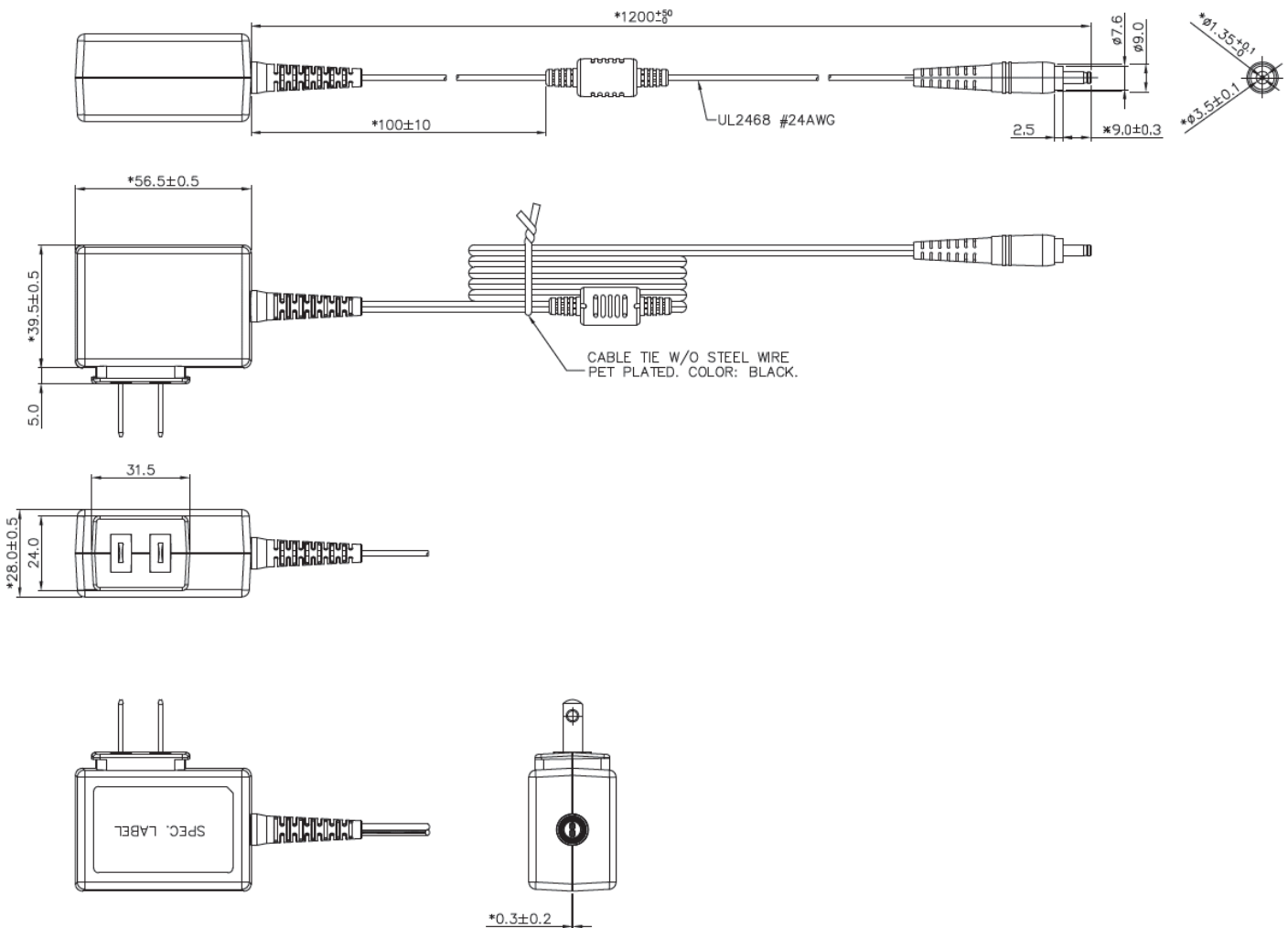

Notes

- Dimensions are in mm.
- The plug's polarity: $\ominus \text{---} \oplus$

MDS Medical AC-DC Wall Mount Adapter

5Volt, 5Watt / MDS-005AAS05 B□

MDS-005AAS05 BU

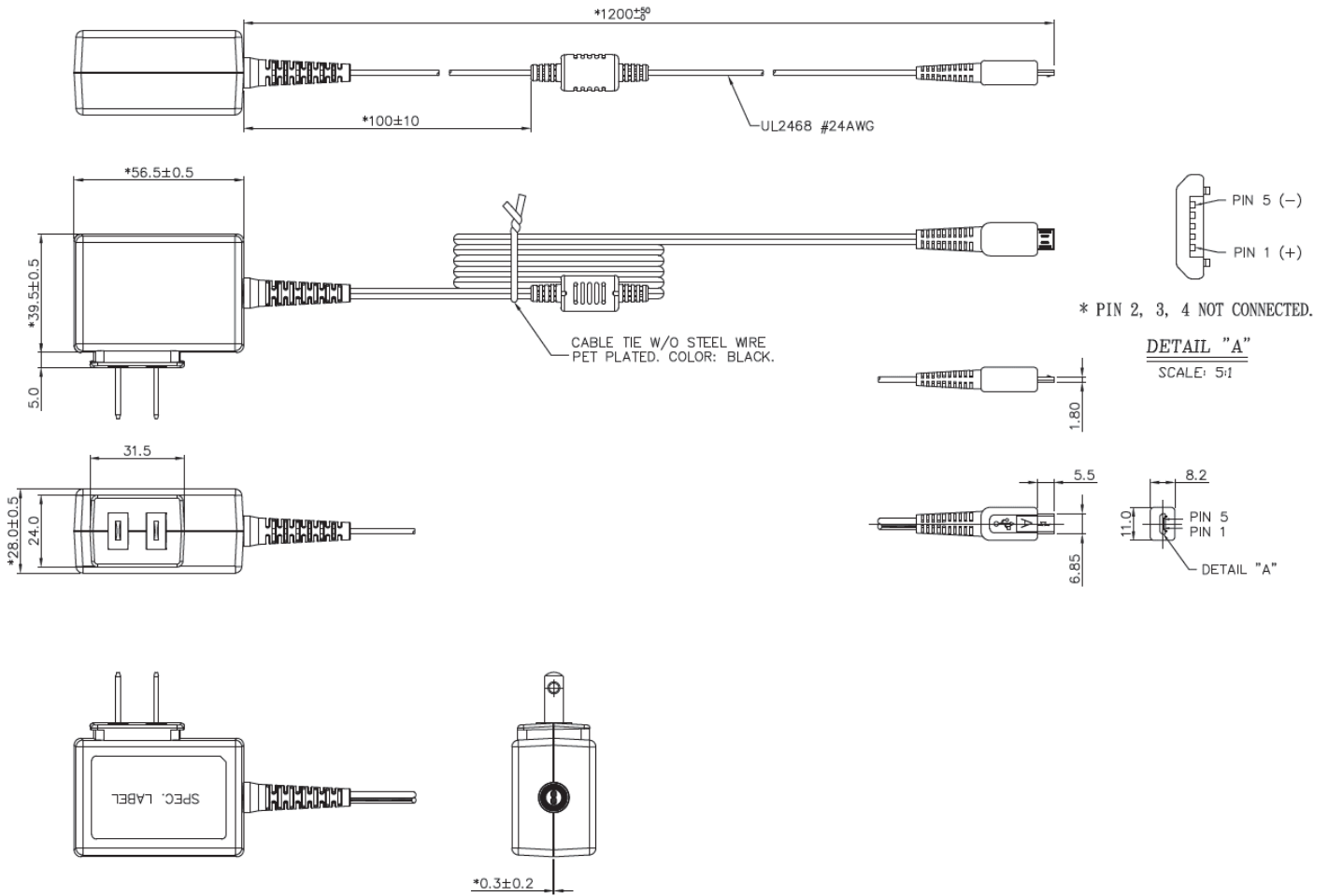

Notes

- Dimensions are in mm.

MDS Medical AC-DC Wall Mount Adapter

5Volt, 5Watt / MDS-005AAS05 B□

Functions

Start-up Time

The time required for the output voltage (V_o) to reach 90% of its set value, after the input AC voltage is applied.

Rise Time

The time required for the output voltage (V_o) to change from 10% to 90% of its steady state value.

Hold-up Time

Hold up time is the time when the AC input collapses and output voltage retains regulation for a certain period of time. The time required for the output to reach 95% of its set value, after the input voltage is removed.

■ Graph illustrating the Start-up Time, Rise Time, and Hold-up Time

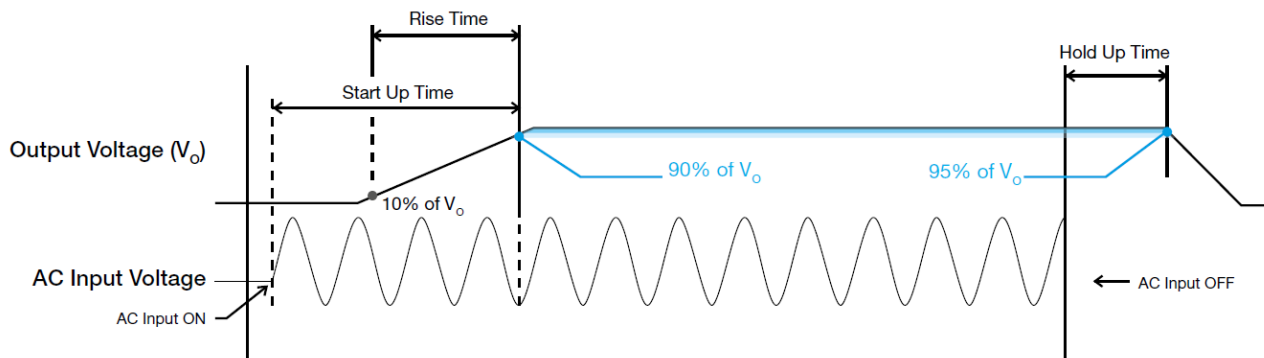

MDS Medical AC-DC Wall Mount Adapter

5Volt, 5Watt / MDS-005AAS05 B□

Dynamic Response

The power supply output voltage will remain within $\pm 10\%$ of its steady state value, when subjected to a dynamic load change from 50 to 100% of its rated current.

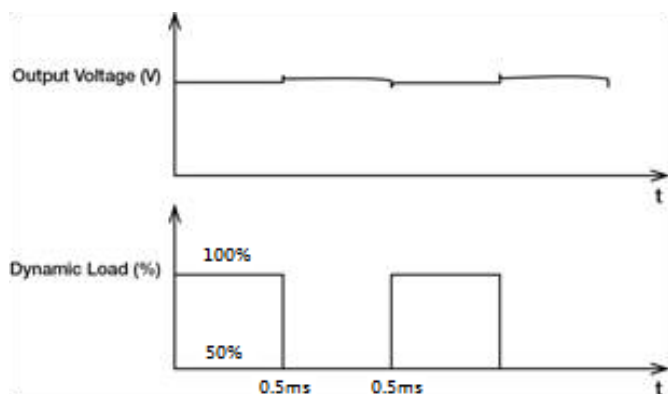

Inrush Current

Inrush current is the input current that occurs when the input voltage is first applied. For AC input voltages, the maximum peak value of inrush current will occur during the first half cycle of the applied AC voltage. This peak value decreases exponentially during subsequent cycles of AC voltage.

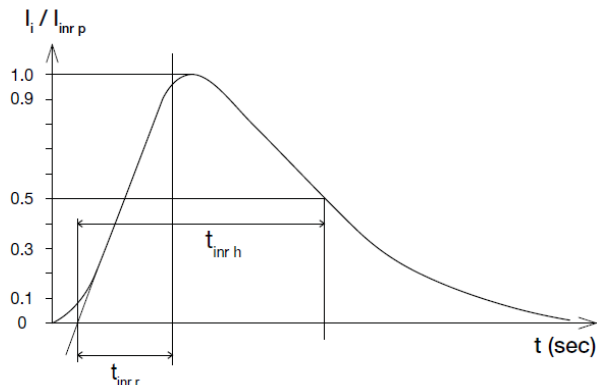

Overvoltage Protection

The power supply's overvoltage circuit will be activated when its internal feedback circuit fails. The power supply will shut down before the output reaches the maximum value shown in "Protections" section on page 4. The output will fall to approximately zero volts, but will not latch off. The output will remain at this value, until the cause of the failure is no longer present. The output will then return to its' rated operating voltage. Removal and reapplication of input voltage, in order to restore rated output voltage (after cause of failure is no longer present) is not required.

Short Circuit Protection

The power supply's output OLP/OCP function also provides protection against short circuits. When a short circuit is applied, the output current will operate in "Hiccup mode", as shown in the illustration in the OLP/OCP section on this page. The power supply will return to normal operation after the short circuit is removed.

Overload & Over current Protections

The power supply's Overload (OLP) and Over current (OCP) Protections will be activated when output current is between 110% and 130% of I_o (Max load). Upon such an occurrence, V_o will start to drop. Once the power supply has reached its maximum power limit, the protection will be activated. and the power supply will go into "Hiccup mode" (Auto-Recovery). The power supply will recover once the fault condition causing the OLP and OCP is removed and I_o is back within the specified limit.

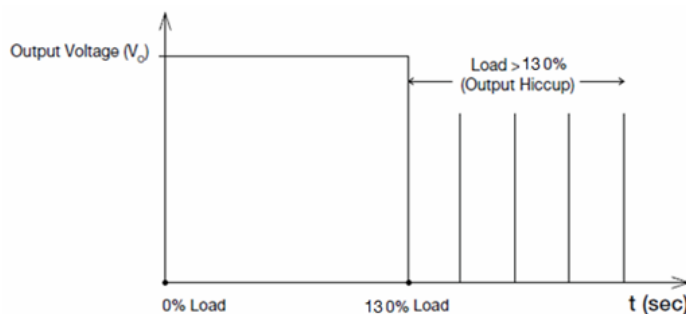

Additionally, if the I_o is $< 130\%$ but $> 110\%$ for a prolonged period of time (depending on the load), the Over Temperature Protection (OTP) will be activated due to high temperature on critical components. The power supply will then go into hiccup mode until the fault is removed; and, the input voltage is removed, then reappplied.

Over Temperature Protection

As mentioned above, the power supply also has Over Temperature Protection (OTP). This is activated when the overload condition persists for an extended duration and the output current is below the overload trigger point but $> 100\%$ load. In the event of a higher operating condition at 100% load, the power supply will run into OTP when the surrounding air temperature is higher than the operating temperature. When activated, the output voltage will go into hiccup mode until the input voltage is removed; then, reapplied, and the surrounding air temperature drops to its normal operating temperature.

MDS Medical AC-DC Wall Mount Adapter

5Volt, 5Watt / MDS-005AAS05 B□

Attention

Delta provides all information in the datasheets on an "AS IS" basis and does not offer any kind of warranty through the information for using the product. In the event of any discrepancy between the information in the catalog and datasheets, the datasheets shall prevail (please refer to www.DeltaPSU.com for the latest datasheets information). Delta shall have no liability of indemnification for any claim or action arising from any error for the provided information in the datasheets. Customer shall take its responsibility for evaluation of using the product before placing an order with Delta.

Delta reserves the right to make changes to the information described in the datasheets without notice.

Certificate



Delta has been certified as meeting the requirement of ISO 13485: 2003 and EN ISO 13485:2012 for the design and manufacture of switching power supply and adaptor for medical device.



Delta is approved for the UL Total Certification Program (TCP) approved client laboratory for IEC62368-1. Delta also has participated UL Client Test Data Program (CTDP) for IEC 60601.



Meet Level VI Efficiency Requirement

X-ON Electronics

Largest Supplier of Electrical and Electronic Components

Click to view similar products for [Wall Mount AC Adapters](#) category:

Click to view products by [Delta](#) manufacturer:

Other Similar products are found below :

[ADP-163 E](#) [ADP-167 J](#) [ADP-168 K](#) [ADP-159 A](#) [ADP-165 G](#) [PSAC05A-050L6](#) [RLMDT361800](#) [DA10-050CH](#) [DA5-050US-B](#)
[RLMDT701800](#) [WSU120-2000-R13](#) [WSU180-1330-13](#) [AC-DC ADAPTER 160W](#) [WSU120-2000-13](#) [WSU150-0800-13](#) [WSU075-3200-13](#)
[WSU060-2000-R13](#) [WSU090-2500-13](#) [WSU050-2000-R13](#) [WSU240-1000-13](#) [WSU240-0500-R13](#) [WSU075-1500-13](#) [WSU050-3000-13](#)
[WSU120-1500-13](#) [WSU120-1500-R13](#) [WSU045-1500-13](#) [WSU240-0750-13](#) [WSU090-2500-R13](#) [WSU240-1500-13](#) [WSU180-0660-13](#)
[WSU075-1500-R13](#) [WSU090-1300-13](#) [WSU180-1330-R13](#) [BB-SMI1812VP230C1](#) [WSU050-1500-13](#) [WSU090-0800-13](#) [WSU120-0700-13](#)
[WSU045-3000-13](#) [WSU180-0450-13](#) [WSU150-0560-R13](#) [WSU135-0880-13](#) [WSU120-3000-13](#) [WSU120-1000-R13](#) [WSU090-1300-R13](#)
[WSU060-1250-R13](#) [WSU060-1250-13](#) [WSU045-2000-R13](#) [WSU045-1500-R13](#) [PSAC05A-050L6M](#) [392007-01](#)