



# Medical Power Supply

From The World's No.1 Power Supply Company

July 2017

[www.DeltaPSU.com](http://www.DeltaPSU.com)



# Table of Contents

■ <b>Company Profile</b> .....	<b>1</b>
■ <b>Latest Products</b> .....	<b>2</b>
■ <b>Typical Applications</b> .....	<b>3</b>
■ <b>Selection Guide</b> .....	<b>4-6</b>
■ <b>Standard Products</b> .....	<b>7</b>
Open Frame Power Supply .....	7
■ <b>Open Frame Power Supply</b> .....	<b>8-18</b>
MDS 040APS (12/15/18/24V) .....	8
MDS 065APS (12/15/18/24V) .....	9
MDS 100APS (12/15/18/24V) .....	10
MDS 100BPS (12/15/18/24V) .....	11
MDS 100AP401 (5.1/12/-15/15V) .....	12
MDS 200A (12/24V) .....	13
MDS 250A (12/24V) .....	14
MDS 300A (12/18/24/48V) .....	15
MDS 400A (12/24V) .....	16
MDS 400AUS (19/24V) .....	17
MEU 600C (24V) .....	18
■ <b>Standard Products</b> .....	<b>19</b>
Enclosed Power Supply .....	19
■ <b>Enclosed Power Supply</b> .....	<b>20-24</b>
MDS 200ADB (12/24V) .....	20
MDS 250ADB (12/24V) .....	21
MDS 300ADB (12/18/24/48V) .....	22
MDS 400ADB (12/24V) .....	23
MEB 1K2 (24V) .....	24
■ <b>Standard Products</b> .....	<b>25</b>
ATX Power Supply .....	25
■ <b>ATX Power Supply</b> .....	<b>26</b>
MDS 350AD701 .....	26
■ <b>Standard Products</b> .....	<b>27</b>
Adapter Power Supply .....	27
■ <b>Adapter Power Supply</b> .....	<b>28-36</b>
MDS 005AAS (5/6V) .....	28
MDS 030AAC (5/7/12/15/24V) .....	29
MDS 060AAS (12/15/19/24V) .....	30
MDS 060BAS (12/19/24V) .....	31
MDS 080AAS (12V) .....	32
MDS 090AAS (15/19/24V) .....	33
MDS 090BAS24 (24V) .....	34
MDS 150AAS (12/19/24V) .....	35
MDS 150CAB19 (19V) .....	36
■ <b>Standards &amp; Approvals</b> .....	<b>37-38</b>
■ <b>Notes</b> .....	<b>39-41</b>

# Company Profile

## Delta Electronics Group

### World's No.1\* Power Supply Company

Delta Electronics Group is the world's largest provider of switching power supplies and a major source for power management and renewable energy solutions. Established in 1971, Delta has sales offices and R&D facilities worldwide with manufacturing plants located in Taiwan, Thailand, China, Mexico, India and Europe.

As a global leader in power electronics, Delta has been adopting Green manufacturing processes, recycling initiatives, waste management programs and environmentally-friendly green buildings. In 2017, Delta Electronics was selected for the prestigious Dow Jones Sustainability Index (DJSI) World for the seventh consecutive year. Amongst many other national and international awards, since 2010, Delta has also received more than 49 internationally recognized technology and design awards.

### 1 Standard Industrial and Medical Power Supplies



Delta offers an extensive range of standard power supplies for industrial and medical applications. The industrial power supplies comprise of DIN rail, panel mount and open frame types and LED drivers. The medical power supplies include open frame, enclosed, ATX and AC adapter types. All Delta standard power supplies offer customers the same industrial leading technology and quality that Delta's ODM partners are familiar with. Due to Delta's highly reliable products and world class customer support, we have been expanding our product portfolio aggressively to meet the global demands which have been growing annually. Please visit our standard product homepage at [www.DeltaPSU.com](http://www.DeltaPSU.com) for more product information.

### 2 Modified Standard Power Supplies



Many top tier electronics companies on the Fortune® 500 list have long regarded Delta as a trusted ODM partner. These companies expect nothing less than the best technology and quality. With decades of industrial leading manufacturing and design experiences in ODM power management products, the Medical Power Supply team can also offer our customers modified standard products by leveraging from the wide range of standard products in our catalog. Modified standard products enable our customers to optimize their costs and product development time. For further query, please contact your local Delta distributor or simply send your query to [info@deltapsu.com](mailto:info@deltapsu.com).

\* Based on global sales revenue as reported in Micro-Tech Consultants March 2017 Report.

# Latest Products

## Delta Standard Medical Power Supplies

### MEU-600



600W

PAGE 18

- Up to 600W convection cooled in 5" × 8" × 1.57" package
- Full power from 90V to 264V, up to 50°C ambient
- Up to 500K hours MTBF
- 2 × MOPP isolation, Suitable for type BF medical products
- Current Sharing and 5V/1A Stand By

### MEB-1K2



1200W

PAGE 24

- Up to 1200W in 5" × 8.03" × 1.59" package
- Full power from 90V to 264V, up to 50°C ambient
- Up to 500K hours MTBF
- 2 × MOPP isolation, Suitable for type BF medical products
- Current Sharing and 5V/2A Stand By

### MDS-350AD701



350W

12V 1U

PAGE 26

- ATX 12V standard function & form factor
- IEC 60601-1 3.1 Ed. (Medical) & IEC 60950-1 (ITE)
- Suitable for type BF patient access applications
- Built-in active PFC
- Compliant with IEC 60601-1-2 4<sup>th</sup> Ed. requirements

### MDS-030AAC



30W

5/7/12/15/24V

PAGE 29



- 5V, 12V, 15V, 24V meet efficiency level VI
- Detachable AC plug with multiple country options
- Compliant with IEC 60601-1-2 4<sup>th</sup> Ed. requirements
- Meets Limited Power Source (LPS) requirements
- Suitable for type BF applications

# Typical Applications

## Delta Standard Medical Power Supplies



- Blood pressure meter
- CPAP/Sleep therapy
- Healthcare information system
- Medical monitors/IT
- Nursing cart
- ECG/EKG
- Infusion pump
- Life Science
- Ophthalmology equipment
- Patient monitor
- Dental equipment
- In-Vitro diagnostic equipment
- Medical ventilator
- Oxygen condenser
- Ultrasound equipment

# Selection Guide

## Delta Standard Medical Power Supplies

New products are frequently introduced. Please visit [www.DeltaPSU.com](http://www.DeltaPSU.com) for latest product updates.

Product Type	Model Name	CC Code	Input Terminal	Output Voltage	Output Current	Output Power	Dimensions	Safety Standards	
Open Frame Power Supply	MDS-040APS12 B	A	JST 2-pin	12V	3.33A	40W	2.0" × 3.0" × 0.9"	CE, UL, CCC	
	MDS-065APS12 B	A	JST 2-pin		5.42A	65W	2.0" × 4.0" × 1.2"	CE, UL, CCC	
	MDS-100APS12 B	A	JST 2-pin		8.33A	100W	3.0" × 5.0" × 1.2"	CE, UL, CCC	
	MDS-100BPS12 B	A	JST 2-pin		8.33A	100W	2.0" × 4.0" × 1.25"	CE, UL, CCC	
	MDS-200APB12*	AA	Molex 2-pin		16.67A	200W	2.0" × 4.0" × 1.4"	CE, UL, CCC, A	
	MDS-250APB12*	AA	Molex 2-pin		20.84A	250W	3.0" × 5.0" × 1.4"	CE, UL, CCC, A	
	MDS-300APB12*	AA	Molex 2-pin		25.00A	300W	3.0" × 5.0" × 1.4"	CE, UL, CCC, A	
	MDS-400APB12*	AA	Molex 2-pin		33.33A	400W	3.0" × 5.0" × 1.4"	CE, UL, CCC, A	
	MDS-040APS15 B	A	JST 2-pin	15V	2.67A	40W	2.0" × 3.0" × 0.9"	CE, UL, CCC	
	MDS-065APS15 B	A	JST 2-pin		4.20A	65W	2.0" × 4.0" × 1.2"	CE, UL, CCC	
	MDS-100APS15 B	A	JST 2-pin		6.67A	100W	3.0" × 5.0" × 1.2"	CE, UL, CCC	
	MDS-100BPS15 B	A	JST 2-pin		6.70A	100W	2.0" × 4.0" × 1.25"	CE, UL, CCC	
	MDS-040APS18 B	A	JST 2-pin	18V	2.22A	40W	2.0" × 3.0" × 0.9"	CE, UL, CCC	
	MDS-065APS18 B	A	JST 2-pin		3.61A	65W	2.0" × 4.0" × 1.2"	CE, UL, CCC	
	MDS-100APS18 B	A	JST 2-pin		5.55A	100W	3.0" × 5.0" × 1.2"	CE, UL, CCC	
	MDS-100BPS18 B	A	JST 2-pin		5.50A	100W	2.0" × 4.0" × 1.25"	CE, UL, CCC	
	MDS-300APB18*	AA	Molex 2-pin		16.66A	300W	3.0" × 5.0" × 1.4"	CE, UL, CCC, A	
	MDS-400AUS19 B	A	DECA 3-pin	19V	21.10A	400W	3.8" × 7.8" × 1.6"	CE, UL, CCC	
	MDS-040APS24 B	A	JST 2-pin		24V	1.67A	40W	2.0" × 3.0" × 0.9"	CE, UL, CCC
	MDS-065APS24 B	A	JST 2-pin			2.71A	65W	2.0" × 4.0" × 1.2"	CE, UL, CCC
	MDS-100APS24 B	A	JST 2-pin			4.17A	100W	3.0" × 5.0" × 1.2"	CE, UL, CCC
	MDS-100BPS24 B	A	JST 2-pin			4.20A	100W	2.0" × 4.0" × 1.25"	CE, UL, CCC
	MDS-200APB24*	AA	Molex 2-pin			8.33A	200W	2.0" × 4.0" × 1.4"	CE, UL, CCC, A
	MDS-250APB24*	AA	Molex 2-pin			10.41A	250W	3.0" × 5.0" × 1.4"	CE, UL, CCC, A
	MDS-300APB24*	AA	Molex 2-pin			12.50A	300W	3.0" × 5.0" × 1.4"	CE, UL, CCC, A
	MDS-400APB24*	AA	Molex 2-pin	16.66A		400W	3.0" × 5.0" × 1.4"	CE, UL, CCC, A	
	MDS-400AUS24 B	A	DECA 3-pin		16.67A	400W	3.8" × 7.8" × 1.6"	CE, UL, CCC	
	MEU-600C24T	AAA	DINKLE 3-pin		25.00A	600W	5.0" × 8.0" × 1.57"	CE, UL, CCC, A	
	MDS-100AP401 B	A	Molex 2-pin	5.1V/12V/-15V/15V	8A/3A/0.8A/0.8A	100W	3.0" × 5.0" × 1.2"	CE, UL, CCC	
	MDS-300APB48*	AA	Molex 2-pin		48V	6.25A	300W	3.0" × 5.0" × 1.4"	CE, UL, CCC, A

\*Product with options for enclosure or U-channel

### Medical Power Supply Model Numbering

MDS	-	XXX	<input type="checkbox"/>	<input type="checkbox"/>	<input type="checkbox"/>	<input type="checkbox"/>	<input type="checkbox"/>	<input type="checkbox"/>
Delta Medical Power Supply MDS-040APS series MDS-065APS series MDS-100APS series MDS-100BPS series MDS-400AUS series		Max power wattage in the product series. May be lower at some voltages. 040: 40W 065: 65W	Family Code A-Z	Product Type P: Open Frame U: U Frame	Input Type Code S: Single Output	Output Voltage 12: 12V 24: 24V	Input Configuration B: Class I 3-pin connector A: Class II 2-pin connector	CC Code For DC connector, label, etc. A: DC connector <sup>1)</sup>
MDS	-	XXX	<input type="checkbox"/>	<input type="checkbox"/>	<input type="checkbox"/>	<input type="checkbox"/>	<input type="checkbox"/>	<input type="checkbox"/>
Delta Medical Power Supply MDS-100AP401		Max power wattage in the product series. May be lower at some voltages. 100: 100W	Family Code A	Product Type P: Open Frame	Output Voltage 401: 5.1V, 12V, -15V, 15V		Input Configuration B: Class I with PE connection	CC Code For DC connector, label, etc. A: DC connector <sup>1)</sup>
MDS	-	XXX	<input type="checkbox"/>	<input type="checkbox"/>	<input type="checkbox"/>	<input type="checkbox"/>	<input type="checkbox"/>	<input type="checkbox"/>
Delta Medical Power Supply MDS-200A series MDS-250A series MDS-300A series MDS-400A series		Max power wattage in the product series. May be lower at some voltages. 200: 200W 250: 250W	Family Code A	Product Type P: Open Frame B: U Frame	Input Type Class II 2-pin connector: A, C, E, G... Class I 3-pin connector: B, D, F, H...	Output Voltage 12: 12V 24: 24V	CC Code For DC connector, label, etc. A: DC connector type <sup>1)</sup>	

1) Refer to technical datasheet or product catalog

MEU	-	XXX	<input type="checkbox"/>	<input type="checkbox"/>	<input type="checkbox"/>	<input type="checkbox"/>	<input type="checkbox"/>	<input type="checkbox"/>
Delta Medical Power Supply U: U-channel  MEU-600C series		Max power wattage in the product series. May be lower at some voltages. 600: 600W	Family Code C	Output Voltage 24: 24V	Inlet Type T: Terminal		CC Code	

Product Type	Model Name	CC Code	Input Terminal	Output Voltage	Output Current	Output Power	Dimensions	Safety Standards
Enclosed Power Supply	MDS-200ADB12	AA	Molex 2-pin	12V	16.67A	200W	2.5" × 4.5" × 1.8"	CE, UL, RoHS, CCC, A
	MDS-250ADB12	AA	Molex 2-pin		20.84A	250W	3.5" × 5.5" × 1.75"	CE, UL, RoHS, CCC, A
	MDS-300ADB12	AA	Molex 2-pin		25.00A	300W	3.5" × 5.5" × 1.75"	CE, UL, RoHS, CCC, A
	MDS-400ADB12	AA	Molex 2-pin	18V	33.33A	400W	3.5" × 5.5" × 1.75"	CE, UL, RoHS, CCC, A
	MDS-300ADB18	AA	Molex 2-pin		16.66A	300W	3.5" × 5.5" × 1.75"	CE, UL, RoHS, CCC, A
	MDS-200ADB24	A	Molex 2-pin	24V	8.33A	200W	2.5" × 4.5" × 1.8"	CE, UL, RoHS, CCC, A
	MDS-250ADB24	AA	Molex 2-pin		10.41A	250W	3.5" × 5.5" × 1.75"	CE, UL, RoHS, CCC, A
	MDS-300ADB24	AA	Molex 2-pin		12.50A	300W	3.5" × 5.5" × 1.75"	CE, UL, RoHS, CCC, A
	MDS-400ADB24	AA	Molex 2-pin		16.67A	400W	3.5" × 5.5" × 1.75"	CE, UL, RoHS, CCC, A
	MEB-1K2A24T	AAA	DINKLE 3-pin		50.00A	1200W	5.0" × 8.03" × 1.59"	CE, UL, RoHS, CCC, A
MDS-300ADB48	AA	Molex 2-pin	48V	6.25A	300W	3.5" × 5.5" × 1.75"	CE, UL, RoHS, CCC, A	

## Medical Power Supply Model Numbering

MDS	-	XXX	□	□	□	□□	□□
Delta Medical Power Supply MDS-200A series MDS-250A series MDS-300A series MDS-400A series		Max power wattage in the product series. May be lower at some voltages. 200: 200W 250: 250W	Family Code A	Product Type D: Enclosure	Input Type Class II 2-pin connector: A, C, E, G... Class I 3-pin connector: B, D, F, H...	Output Voltage 12: 12V 24: 24V	CC Code For DC connector, label, etc. A: DC connector type <sup>1)</sup>























































1) Refer to technical datasheet or product catalog

MEB	-	XXX	□	□□	□	□□□
Delta Medical Power Supply B: Enclosed  MEB-1K2A series		Max power wattage in the product series. May be lower at some voltages. 1K2: 1,200W	Family Code A	Output Voltage 24: 24V	Inlet Type T: Terminal	CC Code

# Selection Guide

## Delta Standard Medical Power Supplies

New products are frequently introduced. Please visit [www.DeltaPSU.com](http://www.DeltaPSU.com) for latest product updates.

Product Type	Model Name	CC Code	AC Inlet	Output Voltage	Output Current	Output Power	Dimensions	Safety Standards
ATX Power Supply	MDS-350AD701	AA	C14	+3.3V, +5V, +5Vsb, +12V1, +12V2, -12V, -5V	8A, 9A, 1.25A, 8A, 8A, 0.25A, 0.1A	350W	3.9" × 7.6" × 1.6"	CE  
Adapter Power Supply	MDS-005AAS05 A	R	Wall mount-China type	5V	1.00A	5W	1.6" × 2.2" × 1.1"	CE  
	MDS-005AAS05 B	R	Wall mount-Japan, USA type		1.00A	5W	1.6" × 2.2" × 1.1"	CE  
	MDS-005AAS05 C	R	Wall mount-EU type		1.00A	5W	1.6" × 2.2" × 1.1"	CE  
	MDS-030AAC05*		Duck Head		3.00A	15W	2.1" × 3.5" × 1.1"	CE  
	MDS-005AAS06 A	R	Wall mount-China type	6V	0.83A	5W	1.6" × 2.2" × 1.1"	CE  
	MDS-005AAS06 B	R	Wall mount-Japan, USA type		0.83A	5W	1.6" × 2.2" × 1.1"	CE  
	MDS-005AAS06 C	R	Wall mount-EU type		0.83A	5W	1.6" × 2.2" × 1.1"	CE  
	MDS-030AAC07*		Duck Head		3.00A	21W	2.1" × 3.5" × 1.1"	CE  
	MDS-030AAC12*		Duck Head	12V	2.00A	24W	2.1" × 3.5" × 1.1"	CE  
	MDS-060AAS12 B	A	C14		5.00A	60W	2.4" × 5.3" × 1.3"	CE  
	MDS-060BAS12 A	B	C8		5.00A	60W	2.4" × 5.3" × 1.3"	CE  
	MDS-080AAS12 A		C8		6.66A	80W	3.0" × 5.9" × 1.6"	CE  
	MDS-150AAS12 B	A	C14		10.00A	120W	3.4" × 6.7" × 1.6"	CE  
	MDS-030AAC15*		Duck Head	15V	2.00A	30W	2.1" × 3.5" × 1.1"	CE  
	MDS-060AAS15 B	A	C14		4.00A	60W	2.4" × 5.3" × 1.3"	CE  
	MDS-090AAS15 B	A	C14		6.00A	90W	2.4" × 5.9" × 1.4"	CE  
	MDS-060AAS19 B	A	C14	19V	3.20A	60W	2.4" × 5.3" × 1.3"	CE  
	MDS-060BAS19 A	A	C8		3.15A	60W	2.4" × 5.3" × 1.3"	CE  
	MDS-090AAS19 B	A	C14		4.74A	90W	2.4" × 5.9" × 1.4"	CE  
	MDS-150AAS19 B	A	C14		7.89A	150W	3.4" × 6.7" × 1.6"	CE  
MDS-150CAB19	AA	C6		7.90A	150W	2.6" × 5.9" × 1.3"	CE  	
MDS-030AAC24*		Duck Head	24V	1.25A	30W	2.1" × 3.5" × 1.1"	CE  	
MDS-060AAS24 B	A	C14		2.50A	60W	2.4" × 5.3" × 1.3"	CE  	
MDS-060BAS24 A	A	C8		2.50A	60W	2.4" × 5.3" × 1.3"	CE  	
MDS-090AAS24 B	A	C14		3.75A	90W	2.4" × 5.9" × 1.4"	CE  	
MDS-090BAS24 A	B	C8		3.75A	90W	3.0" × 5.9" × 1.6"	CE  	
MDS-150AAS24 B	A	C14		6.25A	150W	3.4" × 6.7" × 1.6"	CE  	

\*Please refer to technical datasheet to get detailed information

### Medical Power Supply Model Numbering

MDS	-	XXX	<input type="checkbox"/>	<input type="checkbox"/>	<input type="checkbox"/>	<input type="checkbox"/>	<input type="checkbox"/>	
Delta Medical Power Supply MDS-350AD701		Max power wattage in the product series. May be lower at some voltages. 350: 350W	Family Code A	Product Type D: Enclosure	Output Voltage 701: +3.3V, +5V, +5Vsb, +12V1, +12V2, -12V, -5V		CC Code	
MDS	-	XXX	<input type="checkbox"/>	<input type="checkbox"/>	<input type="checkbox"/>	<input type="checkbox"/>	<input type="checkbox"/>	
Delta Medical Power Supply MDS-005AAS series MDS-060AAS series MDS-060BAS series MDS-080AAS series MDS-090AAS series MDS-090BAS series MDS-150AAS series		Max power wattage in the product series. May be lower at some voltages. 005: 5W 060: 60W	Family Code A-Z	Product Type A: Adapter	# of Output S: Single Output	Output Voltage 12: 12V 24: 24V	Input Configuration A: C8 B: C14 C: NA  A: CN B: US C: EU for 005AAS	CC Code For DC plug, cable length, label, etc.
MDS	-	XXX	<input type="checkbox"/>	<input type="checkbox"/>	<input type="checkbox"/>	<input type="checkbox"/>	<input type="checkbox"/>	
Delta Medical Power Supply MDS-150CAB19A		Max power wattage in the product series. May be lower at some voltages. 150: 150W	Family Code C	Product Type A: Adapter	Input Type Class II C8/C14: A, C, E, G... Class I C6/C14: B, D, F, H...	Output Voltage 19: 19V	CC Code AA-ZX Power cord length, plug, label, etc.	
MDS	-	XXX	AAC	<input type="checkbox"/>	<input type="checkbox"/>	<input type="checkbox"/>	<input type="checkbox"/>	
Delta Medical Power Supply MDS-030 series		Max power wattage in the product series. May be lower at some voltages. 030: 30W	Family Code	Output Voltage (Single Output) 05: 5V 07: 7V 12: 12V 15: 15V <sup>1)</sup> 24: 24V	CC Code DC plug type and output cable length A: 2.1 × 5.5 × 10 mm DC plug, and 1200 mm cable length B: 2.1 × 5.5 × 12 mm DC plug, and 1200 mm cable length <sup>2)</sup>	CC Code Country duck-head type A: China B: United States <sup>2)</sup> C: European <sup>2)</sup> D: United Kingdom <sup>2)</sup> E: Australia <sup>2)</sup> G: Korea <sup>2)</sup> H: India <sup>2)</sup> J: Argentina <sup>2)</sup> K: Brazil <sup>2)</sup> M: South Africa <sup>2)</sup>		

1) MDS-030AAC15 BB is not available

2) Options



# Standard Products

## Open Frame Power Supply

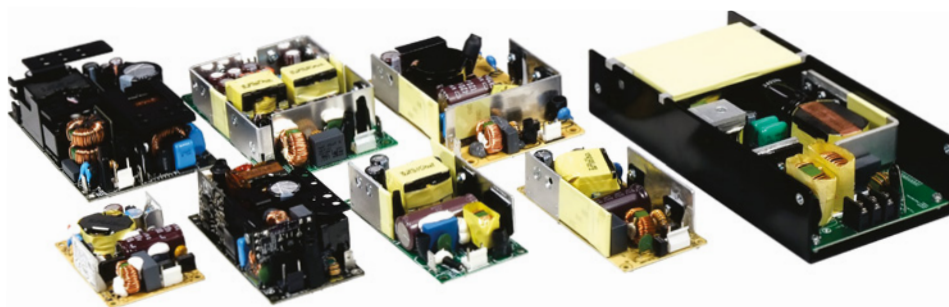

The MDS Open Frame series provides high performance and reliable solutions for internal power supplies in medical equipment or systems.

### Typical Applications



### Notes:



All Delta Medical Power products conform to the European directive 2011/65/EU. RoHS is the abbreviation for "Restriction of the use of certain hazardous substances".



Delta has been certified for meeting the requirements of ISO 13485: 2003 and EN ISO 13485: 2012 for the design and production of switching power supplies and adaptors for medical devices.



In addition to the UL Total Certification Program (TCP) approved client laboratory for IEC 60950 and IEC 60065, Delta has also participated in the UL Client Test Data Program (CTDP) for IEC 60601.

Open Frame Power Supply

Enclosed Power Supply

ATX Power Supply

Adapter Power Supply

# MDS 040APS Open Frame Power Supply

## 12/15/18/24V 40 WATTS



### HIGHLIGHTS & FEATURES

- Safety approvals for medical and IT applications
- Over-Voltage/Load/Temperature & Short Circuit Protections
- Low leakage current (<0.1mA Normal & <0.3mA single fault)
- Compliant with IEC 60601-1-2 4<sup>th</sup> Ed. Requirements
- Risk management report available
- 2" x 3" x 0.9" package
- 3 million hours MTBF
- 2 x MOPP isolation
- 3 years warranty

### GENERAL SPECIFICATIONS

OUTPUT	040APS12	040APS15	040APS18	040APS24
Output Voltage	12V	15V	18V	24V
Output Current (Max)	3.33A	2.67A	2.22A	1.67A
Output Power	40W	40W	40W	40W
Efficiency	86%	87%	87%	87%
<b>INPUT</b>				
Input Voltage Range	90-264Vac			
Ripple & Noise	<1% (25°C at 10uF/0.47uF with 20MHz bandwidth)			
Load Regulation	±1%			
Leakage Current	<0.1mA normal condition, <0.3mA SFC at 264Vac/63Hz			
Input Frequency	47-63Hz			
<b>MECHANICAL</b>				
Dimensions (W x L x H)	50.80 x 76.20 x 23.00 mm (2.0 x 3.0 x 0.9 in)			
EMC & Emissions	EN 55011/EN 55032, FCC Title 47: Class B			
Connector Type	Input: JST 2P B2P3-VH (LF) (SN) Output: JST 4P B4P-VH (LF) (SN)			
Unit Weight	0.80 kg (0.18 lb)			
MTBF	3 million hours			
<b>ENVIRONMENT</b>				
Operating Temperature	-10°C to +70°C			
Storage Temperature	-40°C to +85°C			
Operating Humidity	10-95% RH (Non-condensing)			
Operating Altitude	0-3,000 meters (0-9,840 feet)			
<b>MEDICAL RATING</b>				
Float Rating	B			
MOPP	2 x MOPP			

unit: mm

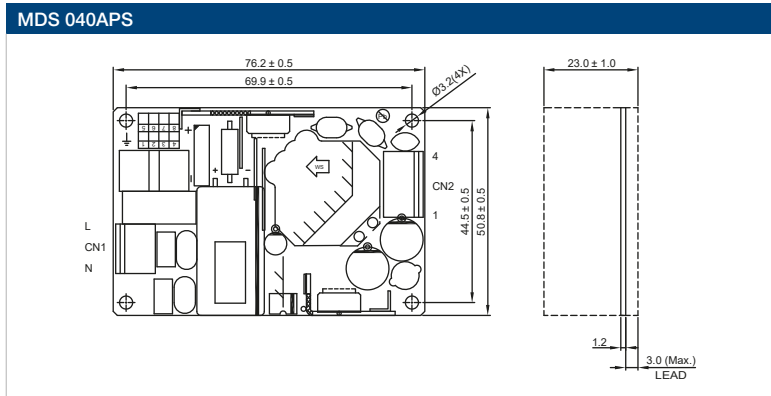

# MDS 065APS Open Frame Power Supply

## 12/15/18/24V 65 WATTS

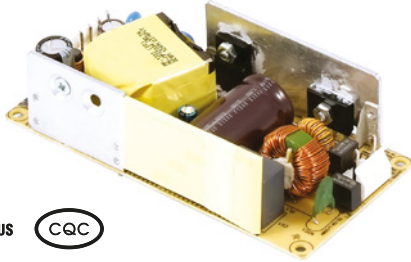

### HIGHLIGHTS & FEATURES

- Safety approvals for medical and IT applications
- Over-Voltage/Load/Temperature & Short Circuit Protections
- Low leakage current (<0.1mA Normal & <0.3mA single fault)
- Compliant with IEC 60601-1-2 4<sup>th</sup> Ed. Requirements
- Risk management report available
- 2.5 million hours MTBF
- 2" x 4" x 1.2" package
- 2 x MOPP isolation
- 3 years warranty

### GENERAL SPECIFICATIONS

OUTPUT	065APS12	065APS15	065APS18	065APS24
Output Voltage	12V	15V	18V	24V
Output Current (Max)	5.42A	4.20A	3.61A	2.71A
Output Power	65W	65W	65W	65W
Efficiency	87%	88%	88%	88%
<b>INPUT</b>				
Input Voltage Range	90-264Vac			
Ripple & Noise	<1% (25°C at 10uF/0.47uF with 20MHz bandwidth)			
Load Regulation	±1%			
Leakage Current	<0.1mA normal condition, <0.3mA SFC at 264Vac/63Hz			
Input Frequency	47-63Hz			
<b>MECHANICAL</b>				
Dimensions (W x L x H)	50.80 x 101.60 x 30.00 mm (2.0 x 4.0 x 1.2 in)			
EMC & Emissions	EN 55011/EN 55032, FCC Title 47: Class B			
Connector Type	Input: JST 2P B2P3-VH (LF) (SN) Output: JST 4P B4P-VH (LF) (SN)			
Unit Weight	0.13 kg (0.29 lb)			
MTBF	2.5 million hours			
<b>ENVIRONMENT</b>				
Operating Temperature	-10°C to +70°C			
Storage Temperature	-40°C to +85°C			
Operating Humidity	10-95% RH (Non-condensing)			
Operating Altitude	0-3,000 meters (0-9,840 feet)			
<b>MEDICAL RATING</b>				
Float Rating	B			
MOPP	2 x MOPP			

unit: mm

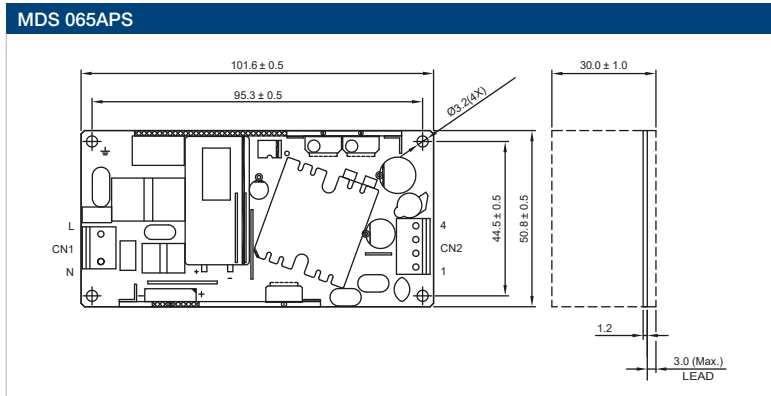

# MDS 100APS Open Frame Power Supply

## 12/15/18/24V 100 WATTS

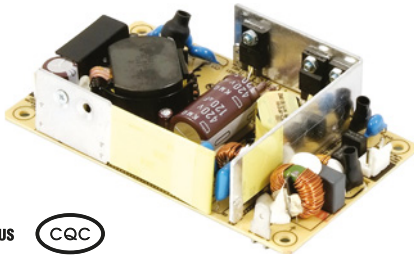

### HIGHLIGHTS & FEATURES

- Safety approvals for medical and IT applications
- 1.528 (for 12V), 2.313 (for 15V), 2.442 (for 18V), 3.174 (for 24V) million hours MTBF
- Over-Voltage/Load/Temperature & Short Circuit Protections
- Low leakage current (<0.1mA Normal & <0.3mA single fault)
- Compliant with IEC 60601-1-2 4<sup>th</sup> Ed. Requirements
- Risk management report available
- 3" x 5" x 1.2" package
- 2 x MOPP isolation
- 3 years warranty

### GENERAL SPECIFICATIONS

OUTPUT	100APS12	100APS15	100APS18	100APS24
Output Voltage	12V	15V	18V	24V
Output Current (Max)	8.33A	6.67A	5.55A	4.17A
Output Power	100W	100W	100W	100W
Efficiency	89%	91%	91%	91%
<b>INPUT</b>				
Input Voltage Range	90-264Vac			
Ripple & Noise	<1% (25°C at 10uF/0.47uF with 20MHz bandwidth)			
Load Regulation	±1%			
Leakage Current	<0.1mA normal condition, <0.3mA SFC at 264Vac/63Hz			
Input Frequency	47-63Hz			
<b>MECHANICAL</b>				
Dimensions (W x L x H)	76.20 x 127.00 x 31.00 mm (3.0 x 5.0 x 1.2 in)			
EMC & Emissions	EN 55011/EN 55032, FCC Title 47: Class B			
Connector Type	Input: JST 2P B2P3-VH (LF) (SN) Earth terminal: Kang Yang PC250 Output: JST 8P B8P-VH (LF) (SN)			
Unit Weight	0.12 kg (0.26 lb)			
MTBF	3 million hours			
<b>ENVIRONMENT</b>				
Operating Temperature	-10°C to +70°C			
Storage Temperature	-40°C to +85°C			
Operating Humidity	10-95% RH (Non-condensing)			
Operating Altitude	0-3,000 meters (0-9,840 feet)			
<b>MEDICAL RATING</b>				
Float Rating	B			
MOPP	2 x MOPP			

unit: mm

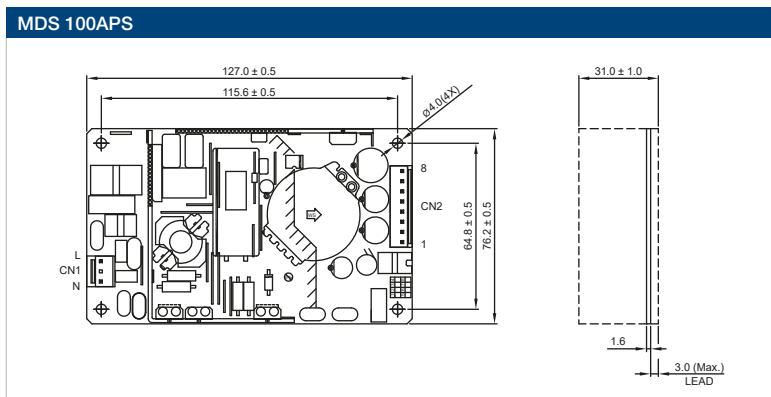

# MDS 100BPS Open Frame Power Supply

## 12/15/18/24V 100 WATTS



### HIGHLIGHTS & FEATURES

- Over-Voltage/Load/Temperature & Short Circuit Protections
- Low leakage current (<0.1mA Normal & <0.3mA single fault)
- 80W with convection cooling; 100W with forced air cooling
- Compliant with IEC 60601-1-2 4<sup>th</sup> Ed. Requirements
- Safety management report available
- 2" x 4" x 1.25" package
- 1 million hours MTBF
- 2 x MOPP isolation
- 3 years warranty

### GENERAL SPECIFICATIONS

OUTPUT	100BPS12	100BPS15	100BPS18	100BPS24
Output Voltage	12V	15V	18V	24V
Output Current (Max)	8.33A	6.70A	5.50A	4.20A
Output Power	100W	100W	100W	100W
Efficiency	87%	88%	88%	89%
<b>INPUT</b>				
Input Voltage Range	90-264Vac			
Ripple & Noise	<1% (25°C at 10uF/0.47uF with 20MHz bandwidth)			
Load Regulation	±1%			
Leakage Current	<0.1mA normal condition, <0.3mA SFC at 264Vac/63Hz			
Input Frequency	47-63Hz			
<b>MECHANICAL</b>				
Dimensions (W x L x H)	50.80 x 101.60 x 31.80 mm (2.0 x 4.0 x 1.25 in)			
EMC & Emissions	EN 55011/EN 55032, FCC Title 47: Class B			
Connector Type	Input: JST 2P B2P3-VH (LF) (SN) Earth terminal: Kang Yang PCH250 Output: JST 4P B4P-VH (LF) (SN)			
Unit Weight	0.15 kg (0.33 lb)			
MTBF	1 million hours			
<b>ENVIRONMENT</b>				
Operating Temperature	-10°C to +70°C			
Storage Temperature	-40°C to +85°C			
Operating Humidity	10-95% RH (Non-condensing)			
Operating Altitude	0-5,000 meters (0-16,400 feet)			
<b>MEDICAL RATING</b>				
Float Rating	B			
MOPP	2 x MOPP			

unit: mm

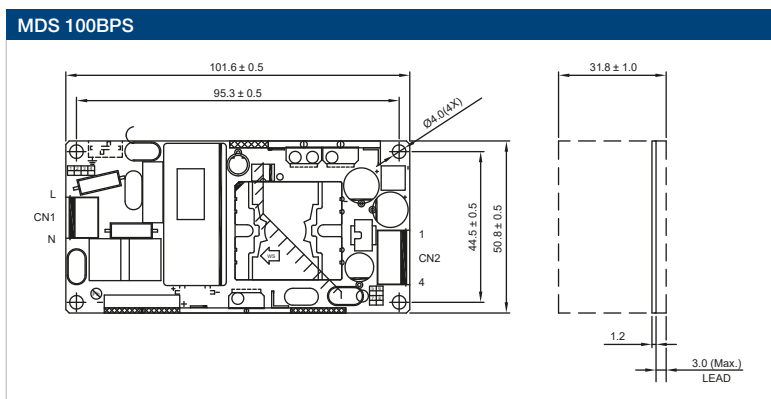

# MDS 100AP401 Open Frame Power Supply

## 5.1/12/-15/15V 100 WATTS

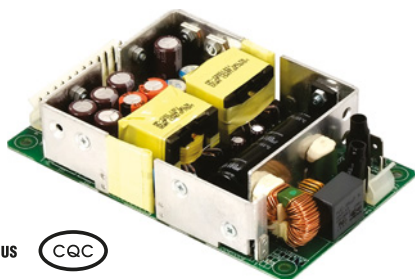

### HIGHLIGHTS & FEATURES

- Safety approvals for medical and IT applications
- Over-Voltage/Load/Temperature & Short Circuit Protections
- Low leakage current (<0.1mA Normal & <0.3mA single fault)
- Compliant with IEC 60601-1-2 4<sup>th</sup> Ed. Requirements
- Risk management report available
- 1 million hours MTBF
- 2 × MOPP isolation
- 3 years warranty

### GENERAL SPECIFICATIONS

OUTPUT		100AP401			
Output Voltage	5.1V	12V	-15V	15V	
Output Current (Max)	8A	3A	0.8A	0.8A	
Output Power (Convection)	65W				
Output Power (Forced Air)	100W				
Efficiency	75%				
INPUT					
Input Voltage Range	90-264Vac				
Ripple & Noise	<1% (25°C at 10uF/0.47uF with 20MHz bandwidth)				
Load Regulation	±2%	±1%	±3%	±3%	
Leakage Current	<0.1mA normal condition, <0.3mA SFC at 264Vac/63Hz				
Input Frequency	47-63Hz				
MECHANICAL					
Dimensions (W × L × H)	76.20 × 127.00 × 30.50 mm (3.0 × 5.0 × 1.2 in)				
EMC & Emissions	EN 55011/EN 55032, FCC Title 47: Class B				
Connector Type	Input: Molex 2P 09-65-2029 Earth terminal: Kang Yang PCH250 Output: Molex 12P 09-65-2128				
Unit Weight	0.25 kg (0.55 lb)				
MTBF	1 million hours				
ENVIRONMENT					
Operating Temperature	-10°C to +70°C				
Storage Temperature	-40°C to +85°C				
Operating Humidity	5-95% RH (Non-condensing)				
Operating Altitude	0-5,000 meters (0-16,400 feet)				
MEDICAL RATING					
Float Rating	B				
MOPP	2 × MOPP				

unit: mm

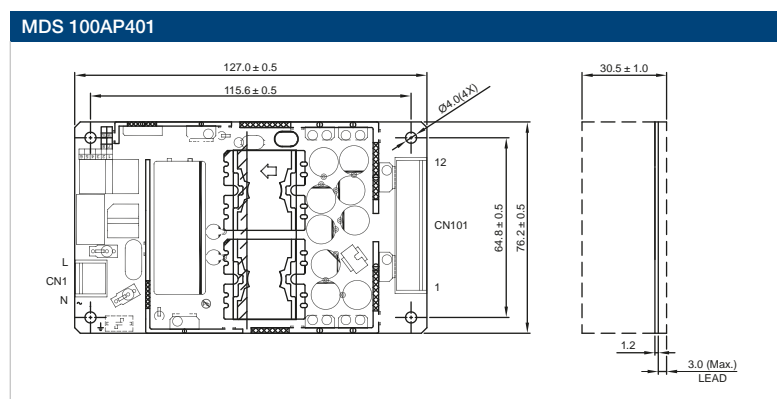

# MDS 200APB Open Frame Power Supply

## 12/24V 200 WATTS

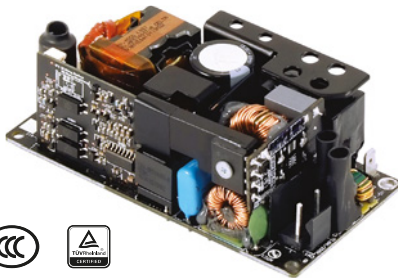

### HIGHLIGHTS & FEATURES

- Safety approvals for medical and IT applications
- Class B EMI (all models); 4<sup>th</sup> Edition Immunity Compliance (12V models only)
- Up to 140W with convection cooling; 200W with forced air cooling
- Compliant with IEC 60601-1-2 4<sup>th</sup> Ed. Requirements
- Enclosed cover design option available
- Suitable for type BF medical product
- Up to 800K hours MTBF
- 2" x 4" x 1.4" package
- Power Good signal

### GENERAL SPECIFICATIONS

OUTPUT	200APB12	200APB24
Output Voltage	12V	24V
Output Current (Max)	16.67A	8.33A
Output Power (Convection)	130W	140W
Output Power (Forced Air)	200W	200W
Efficiency	91% @ 115V, 93% @ 230V	94%
<b>INPUT</b>		
Input Voltage Range	90-264Vac	
Ripple & Noise	<1% (25°C at 10uF/0.47uF with 20MHz bandwidth)	
Load Regulation	±1%	
Leakage Current	<0.1mA normal condition, <0.3mA SFC at 264Vac/63Hz	
Input Frequency	47-63Hz	
<b>MECHANICAL</b>		
Dimensions (W x L x H)	50.80 x 101.60 x 35.60 mm (2.0 x 4.0 x 1.4 in)	
EMC & Emissions	Class I model: EN 55011/EN 55032, FCC Title 47: Class B	
Connector Type	Input: Molex 171813-9998 or Equivalent Earth terminal: PINGOOD JP-13T Output: JST B4P-VH(LF)(SN) Signal connector: Molex 87438-0243	
Unit Weight	0.20 kg (0.44 lb)	
MTBF	800K hours	
<b>ENVIRONMENT</b>		
Operating Temperature	-10°C to +70°C	
Storage Temperature	-40°C to +85°C	
Operating Humidity	5-95% RH (Non-condensing)	
Operating Altitude	0-5,000 meters (0-16,400 feet)	
<b>MEDICAL RATING</b>		
Float Rating	BF	
MOPP	2 x MOPP	

unit: mm

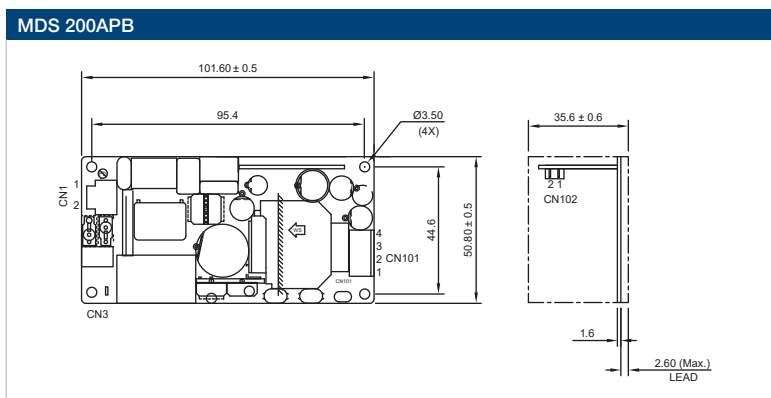

# MDS 250APB Open Frame Power Supply

## 12/24V 250 WATTS

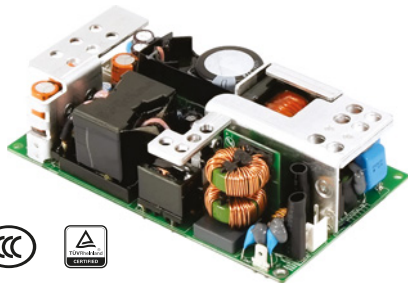

### HIGHLIGHTS & FEATURES

- Power Good signal, Remote Sense, Remote Inhibit
- Compliant with IEC 60601-1-2 4<sup>th</sup> Ed. Requirements
- Up to 150W with convection cooling; 250W with forced air cooling
- Class B EMI; 4<sup>th</sup> Edition Immunity Compliance
- Safety rated for medical and IT applications
- Enclosed cover design option available
- Suitable for type BF medical product
- Up to 500K hours MTBF
- 3" x 5" x 1.4" package

### GENERAL SPECIFICATIONS

OUTPUT	250APB12	250APB24
Output Voltage	12V	24V
Output Current (Max)	20.84A	10.41A
Output Power (Convection)	150W	150W
Output Power (Forced Air)	250W	250W
Efficiency	91%	
INPUT		
Input Voltage Range	90-264Vac	
Ripple & Noise	<1% (25°C at 10uF/0.47uF with 20MHz bandwidth)	
Load Regulation	±1%	
Leakage Current	<0.1mA normal condition, <0.3mA SFC at 264Vac/60Hz	
Input Frequency	47-63Hz	
MECHANICAL		
Dimensions (W x L x H)	76.50 x 127.30 x 36.10 mm (3.0 x 5.0 x 1.4 in)	
EMC & Emissions	Class I model: EN 55011/EN 55032, FCC Title 47: Class B Class II model: EN 55011/EN 55032, FCC: Class B for conducted, Class A for radiated	
Connector Type	Input: Molex 171813-9998 or Equivalent Earth terminal: PINGOOD JP-13T Output: Kang Yang PCB-12 Signal Connector: Molex 104141-1010	
Unit Weight	0.41 kg (0.89 lb)	
MTBF	500K hours	
ENVIRONMENT		
Operating Temperature	-10°C to +70°C	
Storage Temperature	-40°C to +85°C	
Operating Humidity	5-95% RH (Non-condensing)	
Operating Altitude	0-5,000 meters (0-16,400 feet)	
MEDICAL RATING		
Float Rating	BF	
MOPP	2 x MOPP	

unit: mm

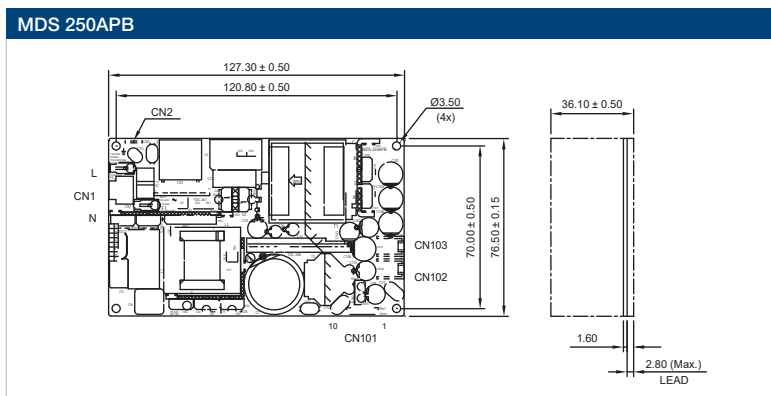



# MDS 300APB Open Frame Power Supply

## 12/18/24/48V 300 WATTS

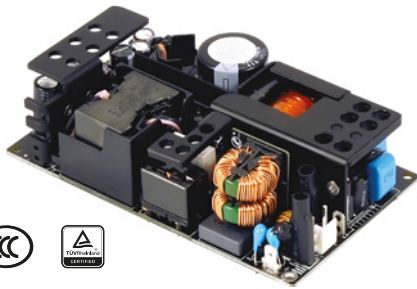

### HIGHLIGHTS & FEATURES

- Power Good signal, Remote Sense, Remote Inhibit
- Class B EMI (all models); 4<sup>th</sup> Edition Immunity Compliance (12 & 24V models only)
- Up to 240W with convection cooling; 300W with forced air cooling
- Compliant with IEC 60601-1-2 4<sup>th</sup> Ed. Requirements
- Safety rated for medical and IT applications
- Suitable for type BF medical products
- Enclosed cover kit design available
- Up to 800K hours MTBF
- 3" x 5" x 1.4" package

### GENERAL SPECIFICATIONS

OUTPUT	300APB12	300APB18	300APB24	300APB48
Output Voltage	12V	18V	24V	48V
Output Current (Max)	25.00A	16.66A	12.50A	6.25A
Output Power (Convection)	220W	220W	240W	240W
Output Power (Forced Air)	300W	300W	300W	300W
Efficiency	94%			
<b>INPUT</b>				
Input Voltage Range	90-264Vac			
Ripple & Noise	<1% (25°C at 10uF/0.47uF with 20MHz bandwidth)			
Load Regulation	±1%			
Leakage Current	<0.1mA normal condition, <0.3mA SFC at 264Vac/63Hz			
Input Frequency	47-63Hz			
<b>MECHANICAL</b>				
Dimensions (W x L x H)	76.20 x 127.00 x 35.60 mm (3.0 x 5.0 x 1.4 in)			
EMC & Emissions	Class I model: EN 55011/EN 55032, FCC Title 47: Class B			
Connector Type	Input: Molex 171813-9998 or Equivalent Earth terminal: PINGOOD JP-13T Output: Kang Yang PCB-12 Signal connector: Molex 104141-1010			
Unit Weight	0.41 kg (0.89 lb)			
MTBF	800K hours			
<b>ENVIRONMENT</b>				
Operating Temperature	-10°C to +70°C			
Storage Temperature	-40°C to +85°C			
Operating Humidity	5-95% RH (Non-condensing)			
Operating Altitude	0-5,000 meters (0-16,400 feet)			
<b>MEDICAL RATING</b>				
Float Rating	BF			
MOPP	2 x MOPP			

unit: mm

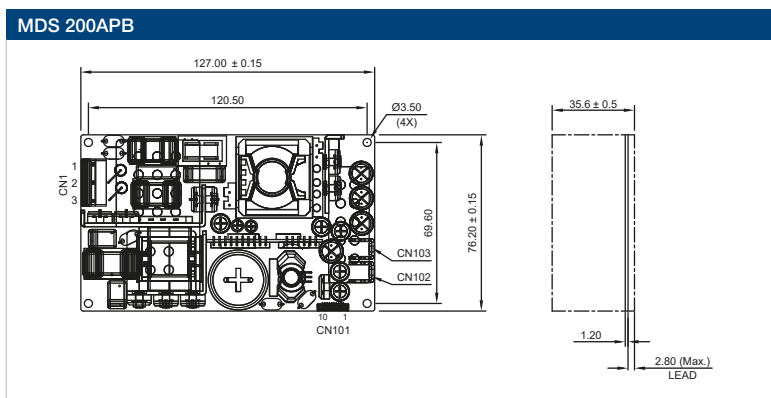

# MDS 400APB Open Frame Power Supply

## 12/24V 400 WATTS

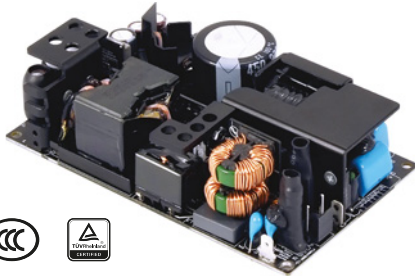

### HIGHLIGHTS & FEATURES

- Power Good signal, Remote Sense, Remote Inhibit
- Compliant with IEC 60601-1-2 4<sup>th</sup> Ed. Requirements
- Up to 200W with convection cooling; 400W with forced air cooling
- Class B EMI (all models); 4<sup>th</sup> Edition Immunity Compliance (12V models only)
- Safety rated for medical and IT applications
- Enclosed cover design option available
- Suitable for type BF medical product
- 5V standby and 12V fan outputs
- Up to 800K hours MTBF
- 3" x 5" x 1.4" package

### GENERAL SPECIFICATIONS

OUTPUT	400APB12	400APB24
Output Voltage	12V	24V
Output Current (Max)	33.33A	16.66A
Output Power (Convection)	200W	200W
Output Power (Forced Air)	400W	400W
Efficiency	89.5% @ 115V, 91.5% @ 230V	92% @ 115V, 93% @ 230V
INPUT		
Input Voltage Range	90-264Vac	
Ripple & Noise	<1% (25°C at 10uF/0.47uF with 20MHz bandwidth)	
Load Regulation	±1%	
Leakage Current	<0.1mA normal condition, <0.3mA SFC at 264Vac/60Hz	
Input Frequency	47-63Hz	
MECHANICAL		
Dimensions (W x L x H)	76.20 x 127.00 x 35.60 mm (3.0 x 5.0 x 1.4 in)	
EMC & Emissions	Class I model: EN 55011/EN 55032, FCC Title 47: Class B	
Connector Type	Input: Molex 171813-9998 or Equivalent Earth terminal: PINGOOD JP-13T Output: Kang Yang PCB-12 Signal Connector: Molex 104141-1010 Fan output connector: JST B2B-PH-K-S(LF)(SN)   Fan output connector: JST S2B-PH-SM4-TB(LF)(SN)	
Unit Weight	0.41 kg (0.89 lb)	
MTBF	500K hours	
ENVIRONMENT		
Operating Temperature	-10°C to +70°C	
Storage Temperature	-40°C to +85°C	
Operating Humidity	5-95% RH (Non-condensing)	
Operating Altitude	0-5,000 meters (0-16,400 feet)	
MEDICAL RATING		
Float Rating	BF	
MOPP	2 x MOPP	

unit: mm

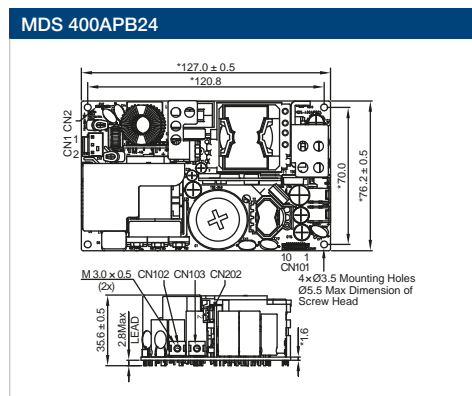
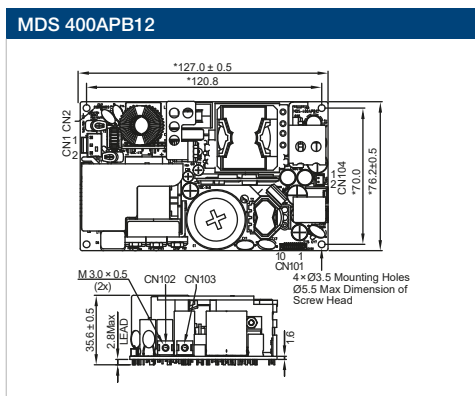

# MDS 400AUS Open Frame Power Supply

## 19/24V 400 WATTS

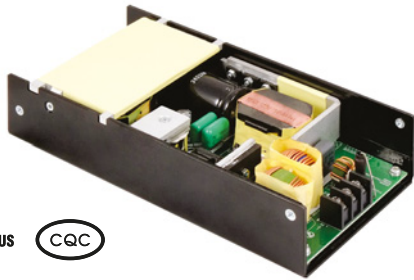

### HIGHLIGHTS & FEATURES

- Over-Voltage/Load/Temperature & Short Circuit Protections
- Low leakage current (<0.1mA Normal & <0.3mA single fault)
- Up to 300W with convection cooling, 400W with forced air
- Compliant with IEC 60601-1-2 4<sup>th</sup> Ed. Requirements
- Safety approvals for medical and IT applications
- Risk management report available
- 2 million hours MTBF
- 2 × MOPP isolation
- 3 years warranty
- Remote sense

### GENERAL SPECIFICATIONS

OUTPUT	400AUS19	400AUS24
Output Voltage	19V	24V
Output Current (Max)	21.10A	16.67A
Output Power (Convection)	300W	300W
Output Power (Forced Air)	400W	400W
Efficiency	91%	92%
<b>INPUT</b>		
Input Voltage Range	90-264Vac	
Ripple & Noise	<1% (25°C at 10uF/0.47uF with 20MHz bandwidth)	
Load Regulation	±2%	
Leakage Current	<0.1mA normal condition, <0.3mA SFC at 264Vac/63Hz	
Input Frequency	47-63Hz	
<b>MECHANICAL</b>		
Dimensions (W × L × H)	97.00 × 198.00 × 41.50 mm (3.8 × 7.8 × 1.6 in)	
EMC & Emissions	EN 55011/EN 55032, FCC Title 47: Class B	
Connector Type	Input: DECA 3P T33-BM1103A301 Output: DECA 4P T33-BM1104A301 Output: JWT 2P A2508WV0-2P	
Unit Weight	0.91 kg (2.01 lb)	
MTBF	2 million hours	
<b>ENVIRONMENT</b>		
Operating Temperature	-10°C to +70°C	
Storage Temperature	-40°C to +85°C	
Operating Humidity	10-95% RH (Non-condensing)	
Operating Altitude	0-3,000 meters (0-9,840 feet)	
<b>MEDICAL RATING</b>		
Float Rating	B	
MOPP	2 × MOPP	

unit: mm

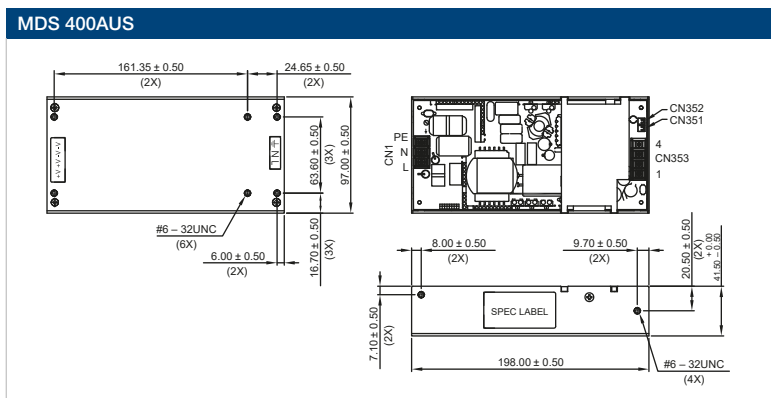

# MEU 600C Open Frame Power Supply

## 24V 600 WATTS



### HIGHLIGHTS & FEATURES

- Up to 600W convection cooled
- Full power from 90V to 264V, up to 50°C ambient
- Up to 500K hours MTBF
- 2 × MOPP isolation, Suitable for type BF medical products
- 5V/1A standby output
- 12V/0.6A fan output for system
- Class B Conducted and Radiated EMI
- IEC 60601-1-2 4<sup>th</sup> Edition Immunity Compliance
- PMBus Ver 1.3 supported
- 5" × 8" × 1.57" package

### GENERAL SPECIFICATIONS

OUTPUT		600C24T
Output Voltage		24V
Output Current (Max)		25.00A
Output Power (Convection)		600W
Efficiency		94.5%
INPUT		
Input Voltage Range		90-264Vac
Ripple & Noise		1%
Load Regulation		2%
Leakage Current		100uA @ NC, 300uA @ SFC touch current, 300uA @ NC, 1000uA @ SFC earth leakage
Input Frequency		47-63HZ
MECHANICAL		
Dimensions (W × L × H)		127.00 × 203.20 × 40.00 mm (5.0 × 8.0 × 1.57 in)
EMC & Emissions		EN 55011/EN 55032, FCC Title 47: Class B
Connector Type		Input terminal: DINKLE DT-35-B01W-03 Output terminal mating screw: M5*0.8*8 Control connector: Molex 87833-1420 Communication connector: Molex 87833-1031 Fan output connector (CN801): JST:S2B-PH-SM4-TB
Unit Weight		1.30 kg (2.87 lb)
MTBF		500K hours
ENVIRONMENT		
Operating Temperature		-20°C to +70°C
Storage Temperature		-40°C to +85°C
Operating Humidity		5-95% RH (Non-condensing)
Operating Altitude		0-5,000 meters (0-16,400 feet)
MEDICAL RATING		
Float Rating		BF
MOPP		2 × MOPP

unit: mm

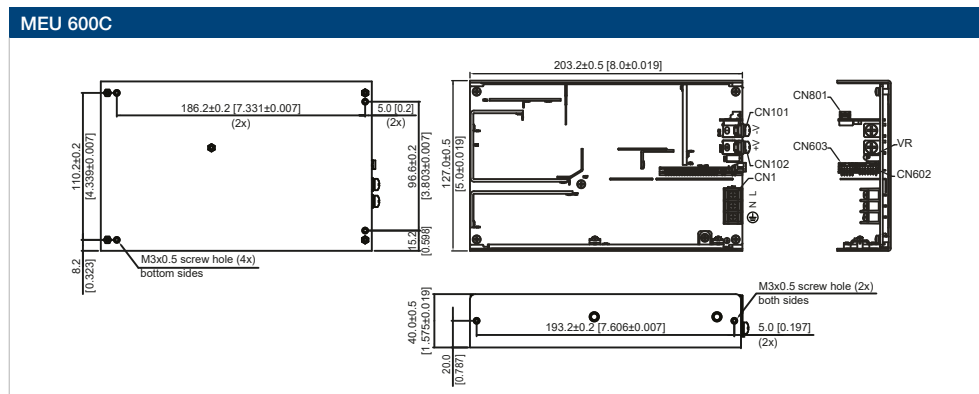

# Standard Products

## Enclosed Power Supply



Most of the MDS series of enclosed power supplies are certified with both medical and ITE safety approvals. Encased in strong metal casing, the series of versatile products can be used in a wide variety of equipment for medical and ITE applications.

### Typical Applications



Medical IT Industry General

### Notes:



All Delta Medical Power products conform to the European directive 2011/65/EU. RoHS is the abbreviation for "Restriction of the use of certain hazardous substances".



Delta has been certified for meeting the requirements of ISO 13485: 2003 and EN ISO 13485: 2012 for the design and production of switching power supplies and adaptors for medical devices.



In addition to the UL Total Certification Program (TCP) approved client laboratory for IEC60950 and IEC60065, Delta has also participated in the UL Client Test Data Program (CTDP) for IEC 60601.

Open Frame Power Supply

Enclosed Power Supply

ATX Power Supply

Adapter Power Supply

# MDS 200ADB Enclosed Power Supply

## 12/24V 200 WATTS



### HIGHLIGHTS & FEATURES

- Up to 120W with convection cooling; 200W with forced air cooling
- Compliant with IEC 60601-1-2 4<sup>th</sup> Ed. Requirements
- 2.5" × 4.5" × 1.8" Package with enclosure
- Suitable for type BF medical product
- IT & Medical Safety Approvals
- Up to 800K Hours MTBF
- Power Good signal

### GENERAL SPECIFICATIONS

OUTPUT	200ADB12	200ADB24
Output Voltage	12V	24V
Output Current (Max)	16.67A with 8.5 CFM forced air	8.33A with 5.5 CFM forced air
Output Power (Convection)	110W	120W
Output Power (Forced Air)	200W	200W
Efficiency	91% @ 115V/60Hz, 93% @ 230V/50Hz	92% @ 115V/60Hz, 93% @ 230V/50Hz
<b>INPUT</b>		
Input Voltage Range	90-264Vac	
Ripple & Noise	1% pk-pkVrated @ Full load	
Load Regulation	±1%	
Leakage Current	0.1mA @ NC, 0.3mA @ SFC	
Input Frequency	47-63Hz	
<b>MECHANICAL</b>		
Dimensions (W × L × H)	64.70 × 113.90 × 44.70 mm (2.5 × 4.5 × 1.8 in)	
EMC & Emissions	Class I model: EN 55011/EN 55032, FCC Title 47: Class B	
Connector Type	Input: Molex 171813-9998 or Equivalent Earth terminal: PINGOOD JP-13T Output: JST B4P-VH(LF)(SN) Signal connector: Molex 87438-0243	
Unit Weight	0.35 kg (0.76 lb)	
MTBF	800K hours	
<b>ENVIRONMENT</b>		
Operating Temperature	-10°C to +70°C	
Storage Temperature	-40°C to +85°C	
Operating Humidity	5-95% RH (Non-condensing)	
Operating Altitude	0-5,000 meters (0-16,400 feet)	
<b>MEDICAL RATING</b>		
Float Rating	BF	
MOPP	2 × MOPP	

unit: mm

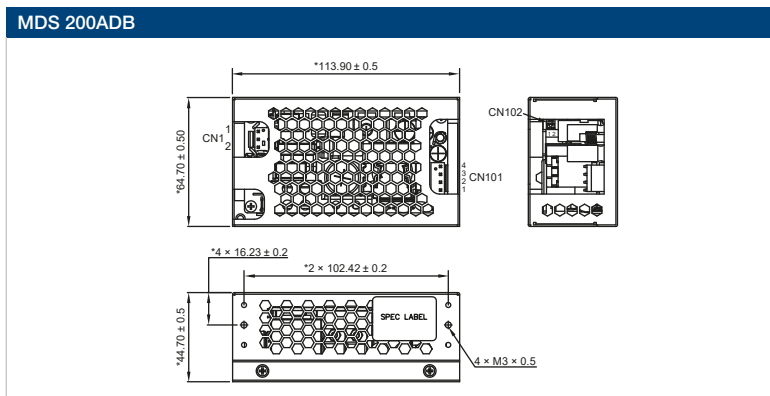

# MDS 250ADB Enclosed Power Supply

## 12/24V 250 WATTS



### HIGHLIGHTS & FEATURES

- Compliant with IEC 60601-1-2 4<sup>th</sup> Ed. Requirements
- Up to 135W with convection cooling; 250W with forced air cooling
- 3.5" x 5.5" x 1.75" Package with enclosure
- Suitable for type BF medical products
- IT & Medical Safety Approvals
- Up to 500K Hours MTBF
- Remote on/off control
- Power Good signal

### GENERAL SPECIFICATIONS

OUTPUT	250ADB12	250ADB24
Output Voltage	12V	24V
Output Current (Max)	20.84A with 10 CFM forced air	10.41A with 10 CFM forced air
Output Power (Convection)	135W	135W
Output Power (Forced Air)	250W	250W
Efficiency	89.45% @ 115V, 90.50% @ 230V	91.85% @ 115V, 92.98% @ 230V
INPUT		
Input Voltage Range	90-264Vac	
Ripple & Noise	1% pk-pk Vrated @ 250W load	
Load Regulation	±1%	
Leakage Current	0.1mA @ NC, 0.3mA @ SFC, 0.1mA @ NC, 0.5mA @ SFC	
Input Frequency	47-63Hz	
MECHANICAL		
Dimensions (W x L x H)	88.90 x 140.00 x 44.40 mm (3.5 x 5.5 x 1.75 in)	
EMC & Emissions	EN 55011/EN 55032, FCC Title 47: Class B	
Connector Type	Input: Molex 171813-9998 or Equivalent Earth terminal: PINGOOD JP-13T Output: Kang Yang PCB-12 Signal connector: Molex 104141-1010	
Unit Weight	0.61 kg (1.35 lb)	
MTBF	500K hours	
ENVIRONMENT		
Operating Temperature	-10°C to +70°C	
Storage Temperature	-40°C to +85°C	
Operating Humidity	5-95% RH (Non-condensing)	
Operating Altitude	0-5,000 meters (0-16,400 feet)	
MEDICAL RATING		
Float Rating	BF	
MOPP	2 x MOPP	

unit: mm

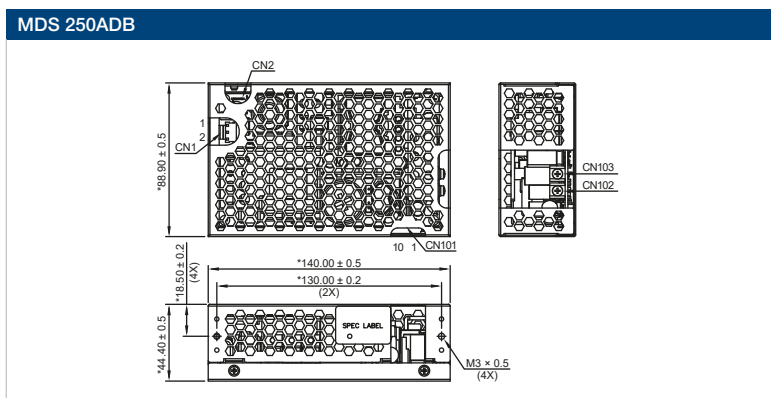

# MDS 300ADB Enclosed Power Supply

## 12/18/24/48V 300 WATTS



### HIGHLIGHTS & FEATURES

- Up to 210W with convection cooling; 300W with forced air cooling
- Compliant with IEC 60601-1-2 4<sup>th</sup> Ed. Requirements
- 3.5" x 5.5" x 1.75" Package with enclosure
- Suitable for type BF medical products
- IT & Medical Safety Approvals
- Up to 800K Hours MTBF
- Remote on/off control
- Power Good signal

### GENERAL SPECIFICATIONS

OUTPUT	300ADB12	300ADB18	300ADB24	300ADB48
Output Voltage	12V	18V	24V	48V
Output Current (Max)	25.00A with 10 CFM forced air	16.66A with 10 CFM forced air	12.50A with 10 CFM forced air	6.25A with 10 CFM forced air
Output Power (Convection)	190W	190W	210W	210W
Output Power (Forced Air)	300W	300W	300W	300W
Efficiency	91.3% @ 115V, 92.6% @ 230V	92.5% @ 115V, 93.5% @ 230V	93% @ 115V, 94% @ 230V	92.5% @ 115V, 93.5% @ 230V
<b>INPUT</b>				
Input Voltage Range	90-264Vac			
Ripple & Noise	1% pk-pk Vrated @ 300W load			
Load Regulation	±1%			
Leakage Current	<0.1mA @ NC, 0.3mA @ SFC, <0.1mA @ NC, 0.5mA @ SFC			
Input Frequency	47-63Hz			
<b>MECHANICAL</b>				
Dimensions (W x L x H)	88.90 x 140.00 x 44.40 mm (3.5 x 5.5 x 1.75 in)			
EMC & Emissions	EN 55011/EN 55032, FCC Title 47: Class B			
Connector Type	Input: Molex 171813-9998 or Equivalent Earth terminal: PINGOOD JP-13T Output: Kang Yang PCB-12 Signal connector: Molex 104141-1010			
Unit Weight	0.61 kg (1.35 lb)			
MTBF	800K hours			
<b>ENVIRONMENT</b>				
Operating Temperature	-10°C to +70°C			
Storage Temperature	-40°C to +85°C			
Operating Humidity	5-95% RH (Non-condensing)			
Operating Altitude	0-5,000 meters (0-16,400 feet)			
<b>MEDICAL RATING</b>				
Float Rating	BF			
MOPP	2 x MOPP			

unit: mm

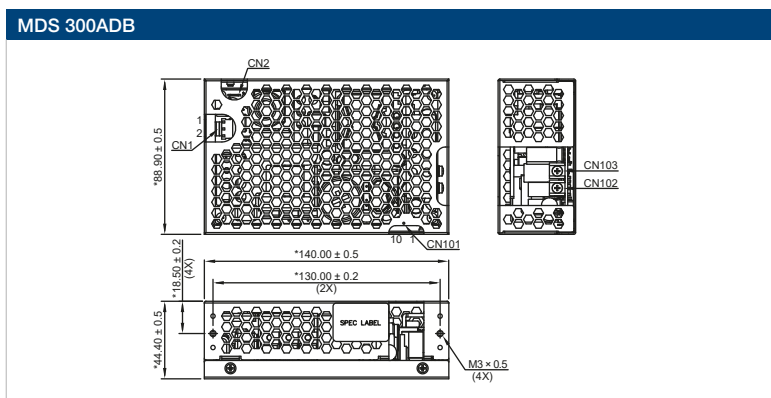



# MDS 400ADB Enclosed Power Supply

## 12/24V 400 WATTS



### HIGHLIGHTS & FEATURES

- Compliant with IEC 60601-1-2 4<sup>th</sup> Ed. Requirements
- 3.5" x 5.5" x 1.75" Package with enclosure
- Suitable for type BF medical products
- Up to 400W with forced air cooling
- IT & Medical Safety Approvals
- Up to 500K Hours MTBF
- Remote on/off control
- Power Good signal
- 12V Fan output

### GENERAL SPECIFICATIONS

OUTPUT	400ADB12	400ADB24
Output Voltage	12V	24V
Output Current (Max)	33.33A with 20 CFM forced air	16.67A with 16 CFM forced air
Output Power (Convection)	400W	400W
Efficiency	89.5% @ 115V/60Hz, 91.5% @ 230V/50Hz	92% @ 115V/60Hz, 93% @ 230V/50Hz
INPUT		
Input Voltage Range	90-264Vac	
Ripple & Noise	150mVpk-pkVrated @ Full load	1%pk-pkVrated @ Full load
Load Regulation	±1%	
Leakage Current	0.1mA @ NC, 0.3mA @ SFC	
Input Frequency	47-63Hz	
MECHANICAL		
Dimensions (W x L x H)	88.90 x 140.00 x 44.40 mm (3.5 x 5.5 x 1.75 in)	
EMC & Emissions	Class I model: EN 55011/EN 55032, FCC Title 47: Class B	
Connector Type	Input: Molex 171813-9998 or Equivalent Earth terminal: PINGOOD JP-13T Output: Kang Yang PCB-12 Signal connector: Molex 104141-1010 Fan output connector: JST B2B-PH-K-S(LF)(SN)   Fan output connector: JST S2B-PH-SM4-TB(LF)(SN)	
Unit Weight	0.61 kg (1.35 lb)	
MTBF	500K hours	
ENVIRONMENT		
Operating Temperature	-10°C to +70°C	
Storage Temperature	-40°C to +85°C	
Operating Humidity	5-95% RH (Non-condensing)	
Operating Altitude	0-5,000 meters (0-16,400 feet)	
MEDICAL RATING		
Float Rating	BF	
MOPP	2 x MOPP	

unit: mm

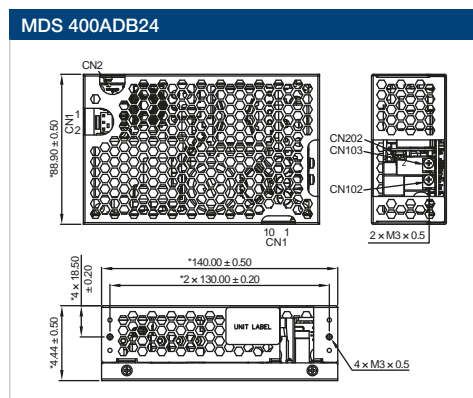
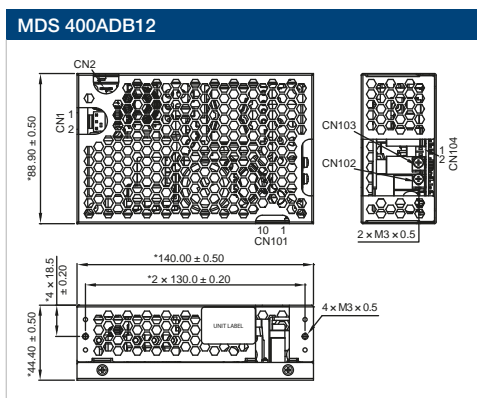

# MEB 1K2 Enclosed Power Supply

## 24V 1200 WATTS



### HIGHLIGHTS & FEATURES

- Up to 1200W in 5" × 8.03" × 1.59" package
- Full power from 90V to 264V, up to 50°C ambient
- Up to 500K hours MTBF
- 2 × MOPP isolation, Suitable for type BF medical products
- Current sharing
- 5V/2A standby output
- Class B Conducted and Radiated EMI
- IEC 60601-1-2 4<sup>th</sup> Edition Immunity Compliance
- PMBus Ver 1.3 supported
- Intelligent fan speed control

### GENERAL SPECIFICATIONS

OUTPUT	
Output Voltage	24V
Output Current (Max)	50.00A
Output Power (Forced Air)	1200W
Efficiency	93%
INPUT	
Input Voltage Range	90-264Vac
Ripple & Noise	1%
Load Regulation	2%
Leakage Current	100uA @ NC, 300uA @ SFC touch current, 300uA @ NC, 1000uA @ SFC earth leakage
Input Frequency	47-63Hz
MECHANICAL	
Dimensions (W × L × H)	127.00 × 204.00 × 40.50 mm (5.0 × 8.03 × 1.59 in)
EMC & Emissions	EN 55011/EN 55032, FCC Title 47: Class B
Connector Type	Input terminal: ANYTEK YK50A Output terminal mating screw: M5*0.8*8 Control connector: Molex 87833-7420 Communication connector: Molex 87833-1051
Unit Weight	1.50 kg (3.30 lb)
MTBF	500K hours
ENVIRONMENT	
Operating Temperature	-20°C to +70°C
Storage Temperature	-40°C to +85°C
Operating Humidity	5-95% RH (Non-condensing)
Operating Altitude	0-5,000 meters (0-16,400 feet)
MEDICAL RATING	
Float Rating	BF
MOPP	2 × MOPP

unit: mm

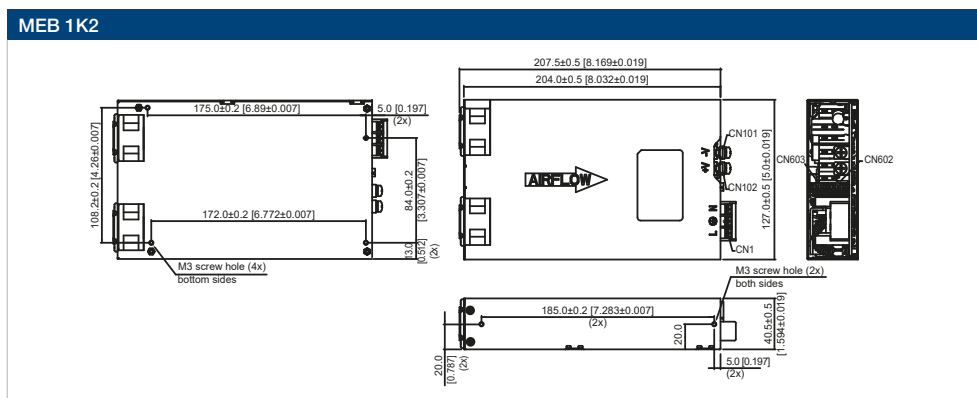

# Standard Products

## ATX Power Supply





Highly reliable design with ATX standard form factor and output cable pin-outs. Certified with medical standards and suitable for use in medical devices with Type BF classification.

### Typical Applications



### Notes:

 All Delta Medical Power products conform to the European directive 2011/65/EU. RoHS is the abbreviation for "Restriction of the use of certain hazardous substances".

 Delta has been certified for meeting the requirements of ISO 13485: 2003 and EN ISO 13485: 2012 for the design and production of switching power supplies and adaptors for medical devices.

 In addition to the UL Total Certification Program (TCP) approved client laboratory for IEC 60950 and IEC 60065, Delta has also participated in the UL Client Test Data Program (CTDP) for IEC 60601.

Open Frame Power Supply

Enclosed Power Supply

ATX Power Supply

Adapter Power Supply

# MDS 350AD701 ATX Power Supply

## ATX 12V 1U



### HIGHLIGHTS & FEATURES

- IEC 60601-1 3.1 Ed. (Medical) & IEC 60950-1 (ITE) approvals
- Compliant with IEC 60601-1-2 4<sup>th</sup> Ed. Requirements
- Suitable for type BF patient access applications
- ATX 12V standard function & form factor
- Maximum output power of 350 watts
- Built-in active PFC

### GENERAL SPECIFICATIONS

OUTPUT	350AD701						
Output Voltage	+3.3V	+5V	+5Vsb	+12V1	+12V2	-12V	-5V
Output Current	8.00A	9.00A	1.25A	8.00A	8.00A	0.25A	0.10A
Output Power (Convection)	350W						
Efficiency	82% @ 115Vac/60Hz, 85% @ 230Vac/50Hz						
INPUT							
Input Voltage Range	90-264Vac						
Ripple & Noise	50mVpp		150mVpp		120mVpp		50mVpp
Load Regulation	±5%					±10%	
Leakage Current	0.1mA @ NC, 0.3mA @ SFC						
Input Frequency	47-63Hz						
MECHANICAL							
Dimensions (W x L x H)	100.00 x 194.00 x 40.50 mm (3.9 x 7.6 x 1.6 in)						
EMC & Emissions	EN 55011/EN 55032, FCC Title 47: Class B						
Connector Type	P1: Molex 39-01-2240 or Equivalent P2: Molex 39-01-2080 or Equivalent P3: Molex 39-01-2040 or Equivalent						
Unit Weight	1.20 kg (2.65 lb)						
MTBF	500K hours						
ENVIRONMENT							
Operating Temperature	0°C to +50°C						
Storage Temperature	-40°C to +85°C						
Operating Humidity	5-95% RH (Non-condensing)						
Operating Altitude	0-5,000 meters (0-16,400 feet)						
MEDICAL RATING							
Float Rating	BF						
MOPP	2 x MOPP						

unit: mm

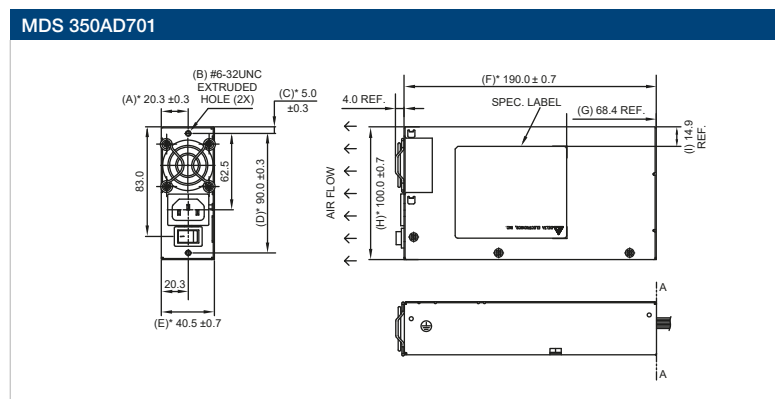

# Standard Products

## Adapter Power Supply



The MDS Adapters series rides on Delta's market leading adapter technology to provide the same high quality external power supplies for medical systems and equipments.

### Typical Applications



Medical IT Industry General

### Notes:



All Delta Medical Power products conform to the European directive 2011/65/EU. RoHS is the abbreviation for "Restriction of the use of certain hazardous substances".



Delta has been certified for meeting the requirements of ISO 13485: 2003 and EN ISO 13485: 2012 for the design and production of switching power supplies and adaptors for medical devices.



In addition to the UL Total Certification Program (TCP) approved client laboratory for IEC 60950 and IEC 60065, Delta has also participated in the UL Client Test Data Program (CTDP) for IEC 60601.

Open Frame Power Supply

Enclosed Power Supply

ATX Power Supply

Adapter Power Supply

# MDS 005AAS Adapter Power Supply

## 5/6V 5 WATTS



### HIGHLIGHTS & FEATURES

- MDS-005AAS05 meet DOE Level VI & ErP 2017
- Over-Voltage/Load/Temperature & Short Circuit Protections
- Compliant with IEC 60601-1-2 4<sup>th</sup> Ed. Requirements
- Safety approvals for medical and IT applications
- Risk management report available
- Small size and low weight
- 1 million hours MTBF
- 2 × MOPP isolation
- 3 years warranty

### GENERAL SPECIFICATIONS

OUTPUT	005AAS05	005AAS06
Output Voltage	5V	6V
Output Current (Max)	1.00A	0.83A
Output Power	5W	5W
Average Efficiency	73.63%	72.40%
<b>INPUT</b>		
Input Voltage Range	90-264Vac	
Ripple & Noise	<200mV (25°C at 10uF/0.47uF with 20MHz bandwidth)	
Load Regulation	±10%	
Leakage Current	<0.1mA normal condition, <0.3mA SFC at 264Vac/63Hz	
Input Frequency	47-63Hz	
<b>MECHANICAL</b>		
Dimensions (W × L × H)	39.50 × 56.50 × 28.00 mm (1.6 × 2.2 × 1.1 in)	
EMC & Emissions	EN 55011/EN 55032, FCC Title 47: Class B	
Connector Type	Input: Wall mount – US & EU & CN type Output: O type/Barrel type/Tuning fork type/Micro USB-B type	
Unit Weight	0.10 kg (0.22 lb)	
MTBF	1 million hours	
<b>ENVIRONMENT</b>		
Operating Temperature	0°C to +40°C	
Storage Temperature	-40°C to +85°C	
Operating Humidity	5-95% RH (Non-condensing)	
Operating Altitude	0-3,000 meters (0-9,840 feet)	
Degree of Protection	IP22	
Protection Against Shock	Class II	
<b>MEDICAL RATING</b>		
Float Rating	BF	
MOPP	2 × MOPP	

unit: mm

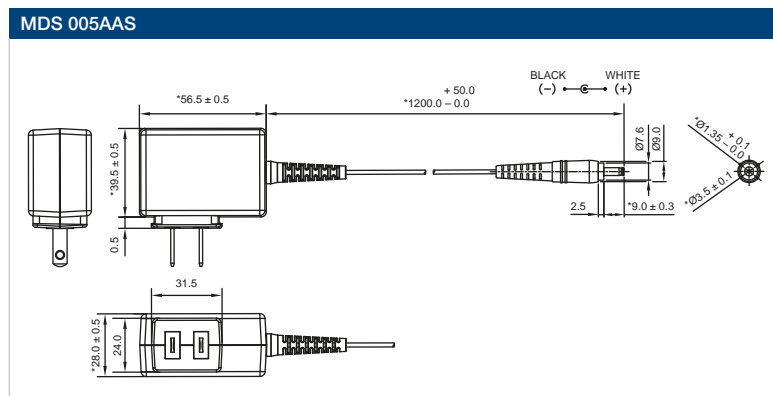

# MDS 030AAC Adapter Power Supply

## 5/7/12/15/24V 30 WATTS



### HIGHLIGHTS & FEATURES

- MDS-030AAC05, 12, 15, 24 Meet DOE Level VI & ErP 2017
- Low Leakage Current. Suitable for type BF applications
- Compliant with IEC 60601-1-2 4<sup>th</sup> Ed. Requirements
- Detachable AC plug with multiple country options
- Class B EMI; 4<sup>th</sup> Edition Immunity Compliance
- Safety rated for medical and IT applications
- 2 × MOPP isolation
- 500K hours MTBF
- 3 years warranty

### GENERAL SPECIFICATIONS

OUTPUT	030AAC05	030AAC07	030AAC12	030AAC15	030AAC24
Output Voltage	5V	7V	12V	15V	24V
Output Current (Max)	3.00A	3.00A	2.00A	2.00A	1.25A
Output Power	15W	21W	24W	30W	30W
Average Efficiency	81.40%	81.40%	86.21%	87.00%	87.00%
<b>INPUT</b>					
Input Voltage Range	90-264Vac				
Ripple & Noise	100mVpk-pk		150mVpk-pk	200mVpk-pk	
Load Regulation	±5%				
Leakage Current	0.1mA @ 264Vac NC, 0.3mA @ 264Vac SFC				
Input Frequency	47-63Hz				
<b>MECHANICAL</b>					
Dimensions (W × L × H)	53.50 × 88.00 × 27.50 mm (2.11 × 3.46 × 1.08 in)				
EMC & Emissions	EN 55011/EN 55032, FCC Title 47: Class B				
Connector Type	Input: Wall mount-CN/US/EU/UK/AU/KR/IN/AR/BZ/SA Output: Barrel type/Tuning fork type				
Unit Weight	0.15 kg (0.33 lb)				
MTBF	500K hours				
<b>ENVIRONMENT</b>					
Operating Temperature	0°C to +40°C				
Storage Temperature	-40°C to +85°C				
Operating Humidity	10-95% RH (Non-condensing)				
Operating Altitude	0-5,000 meters (0-16,400 feet)				
Degree of Protection	IP22				
Protection Against Shock	Class II				
<b>MEDICAL RATING</b>					
Float Rating	BF				
MOPP	2 × MOPP				

unit: mm

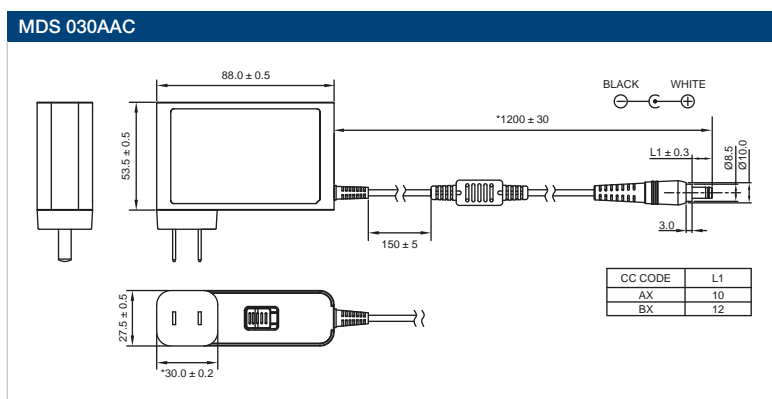

Open Frame Power Supply

Enclosed Power Supply

ATX Power Supply

Adapter Power Supply

# MDS 060AAS Adapter Power Supply

## 12/15/19/24V 60 WATTS



### HIGHLIGHTS & FEATURES

- Over-Voltage/Load/Temperature & Short Circuit Protections
- Low leakage current (<0.1mA Normal & <0.3mA single fault)
- Compliant with IEC 60601-1-2 4<sup>th</sup> Ed. Requirements
- Safety approvals for medical and IT applications
- MDS-060AAS15, 19 meet DOE Level VI & ErP 2017
- MDS-060AAS24 meet DOE Level VI
- Class I protection against shock
- 1 million hours MTBF
- 2 × MOPP isolation
- 3 years warranty

### GENERAL SPECIFICATIONS

OUTPUT	060AAS12	060AAS15	060AAS19	060AAS24
Output Voltage	12V	15V	19V	24V
Output Current (Max)	5.00A	4.00A	3.20A	2.50A
Output Power	60W	60W	60W	60W
Average Efficiency	87%	88%	88%	88%
<b>INPUT</b>				
Input Voltage Range	90-275Vac			
Ripple & Noise	<1% (25°C at 10uF/0.47uF with 20MHz bandwidth)			
Load Regulation	±5%			
Leakage Current	<0.1mA normal condition, <0.3mA SFC at 264Vac/63Hz			
Input Frequency	47-63Hz			
<b>MECHANICAL</b>				
Dimensions (W × L × H)	62.00 × 135.00 × 34.10 mm (2.4 × 5.3 × 1.3 in)			
EMC & Emissions	EN 55011/EN 55032, FCC Title 47: Class B			
Connector Type	Input: C14 socket Output: 4-pin DIN/Barrel type/Tuning fork type			
Unit Weight	0.36 kg (0.79 lb)			
MTBF	1 million hours			
<b>ENVIRONMENT</b>				
Operating Temperature	0°C to +40°C			
Storage Temperature	-40°C to +85°C			
Operating Humidity	10-95% RH (Non-condensing)			
Operating Altitude	0-3,000 meters (0-9,840 feet)			
Protection Against Shock	Class I			
<b>MEDICAL RATING</b>				
Float Rating	BF			
MOPP	2 × MOPP			

unit: mm

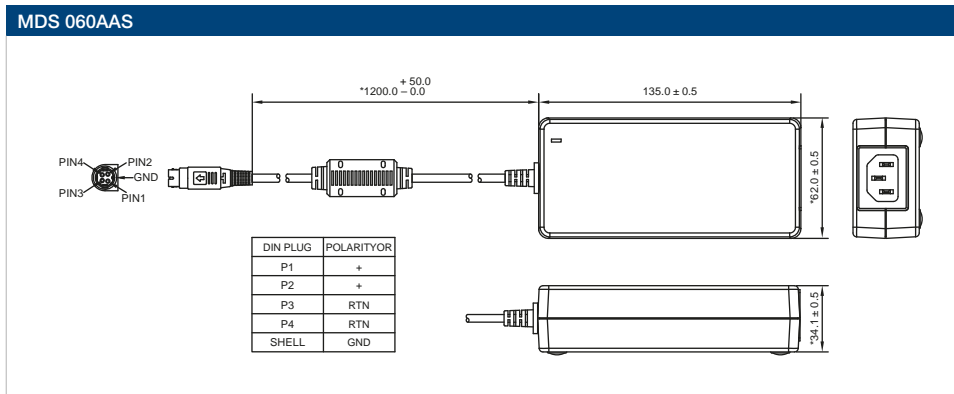



# MDS 060BAS Adapter Power Supply

## 12/19/24V 60 WATTS



### HIGHLIGHTS & FEATURES

- Over-Voltage/Load/Temperature & Short Circuit Protections
- Low leakage current (<0.1mA Normal & <0.3mA single fault)
- Compliant with IEC 60601-1-2 4<sup>th</sup> Ed. Requirements
- Safety approvals for medical and IT applications
- MDS-060BAS12 meet DOE Level VI & ErP 2017
- MDS-060BAS19 meet DOE Level VI
- Class II protection against shock
- 1 million hours MTBF
- 3 years warranty
- 2 × MOPP isolation

### GENERAL SPECIFICATIONS

OUTPUT	060BAS12	060BAS19	060BAS24
Output Voltage	12V	19V	24V
Output Current (Max)	5.00A	3.15A	2.50A
Output Power	60W	60W	60W
Average Efficiency	88%	88%	87%
<b>INPUT</b>			
Input Voltage Range	90-264Vac		
Ripple & Noise	<1% (25°C at 10uF/0.47uF with 20MHz bandwidth)		
Load Regulation	±5%		
Leakage Current	<0.1mA normal condition, <0.3mA SFC at 264Vac/63Hz		
Input Frequency	47-63Hz		
<b>MECHANICAL</b>			
Dimensions (W × L × H)	62.00 × 135.00 × 34.10 mm (2.4 × 5.3 × 1.3 in)		
EMC & Emissions	EN 55011/EN 55032, FCC Title 47: Class B		
Connector Type	Input: C8 socket Output: 4-pin DIN/Barrel type/Tuning fork type		
Unit Weight	0.34 kg (0.75 lb)		
MTBF	1 million hours		
<b>ENVIRONMENT</b>			
Operating Temperature	0°C to +40°C		
Storage Temperature	-40°C to +85°C		
Operating Humidity	10-95% RH (Non-condensing)		
Operating Altitude	0-3,000 meters (0-9,840 feet)		
Degree of Protection	IP22		
Protection Against Shock	Class II		
<b>MEDICAL RATING</b>			
Float Rating	BF		
MOPP	2 × MOPP		

unit: mm

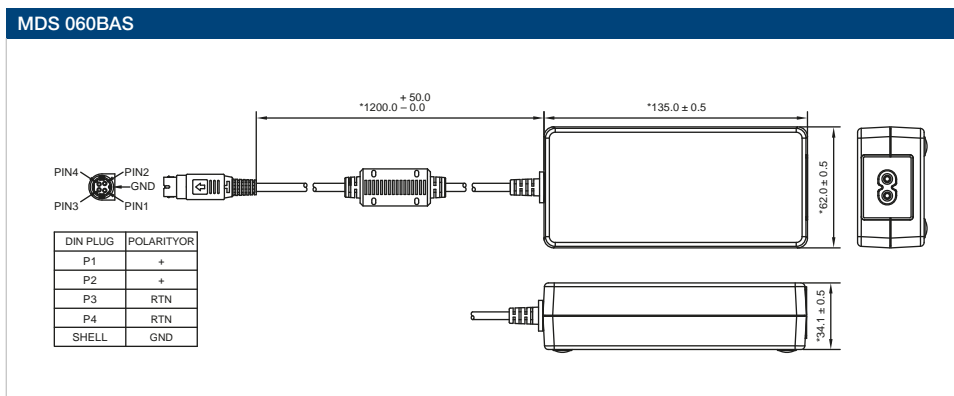

Open Frame Power Supply

Enclosed Power Supply

ATX Power Supply

Adapter Power Supply

# MDS 080AAS Adapter Power Supply

## 12V 80 WATTS



### HIGHLIGHTS & FEATURES

- Safety approvals for medical and IT applications
- Compliant with IEC 60601-1-2 4<sup>th</sup> Ed. Requirements
- Class II input with C8 AC inlet
- Universal input 90-264Vac
- 1 million hours MTBF
- 2 × MOPP isolation
- 3 years warranty

### GENERAL SPECIFICATIONS

<b>OUTPUT</b>	080AAS12	
Output Voltage		12V
Output Current (Max)		6.67A
Output Power		80W
Average Efficiency		80%
<b>INPUT</b>		
Input Voltage Range		90-264Vac
Ripple & Noise		118.4 mVpk-pk @ Rated Load
Load Regulation		±5%
Leakage Current		81.6uA normal condition, 87.4uA single fault condition
Input Frequency		47-63Hz
<b>MECHANICAL</b>		
Dimensions (W × L × H)		75.00 × 150.00 × 40.00 mm (3.0 × 5.9 × 1.6 in)
EMC & Emissions		EN 55011/EN 55032, FCC Title 47: Class B
Connector Type		Input: C8 socket Output: 4-pin DIN/Barrel type/Tuning fork type
Unit Weight		0.50 kg (1.10 lb)
MTBF		1 million hours
<b>ENVIRONMENT</b>		
Operating Temperature		0°C to +40°C
Storage Temperature		-40°C to +85°C
Operating Humidity		10-95% RH (Non-condensing)
Operating Altitude		0-5,000 meters (0-16,400 feet)
Protection Against Shock		Class II
<b>MEDICAL RATING</b>		
Float Rating		BF
MOPP		2 × MOPP

unit: mm

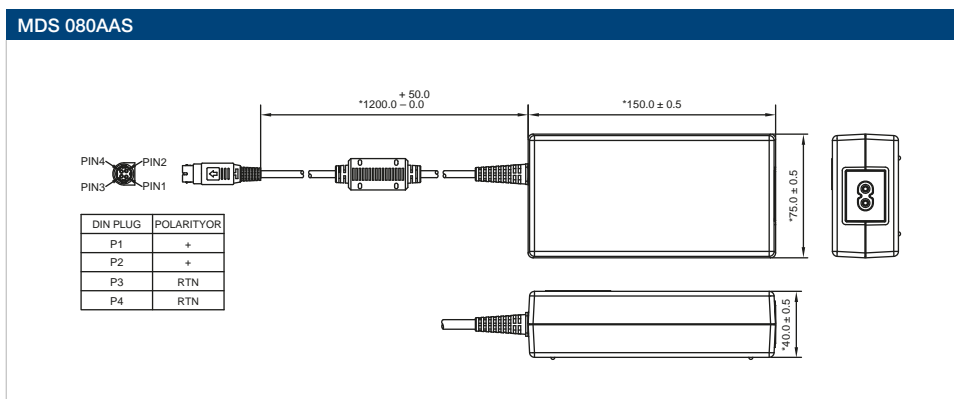

# MDS 090AAS Adapter Power Supply

## 15/19/24V 90 WATTS



### HIGHLIGHTS & FEATURES

- Over-Voltage/Load/Temperature & Short Circuit Protections
- Low leakage current (<0.1mA Normal & <0.3mA single fault)
- Compliant with IEC 60601-1-2 4<sup>th</sup> Ed. Requirements
- Safety approvals for medical and IT applications
- MDS-090AAS15 meet DOE Level VI & ErP 2017
- MDS-090AAS19, 24 meet DOE Level VI
- 1 million hours MTBF
- 2 × MOPP isolation
- 3 years warranty

### GENERAL SPECIFICATIONS

OUTPUT	090AAS15	090AAS19	090AAS24
Output Voltage	15V	19V	24V
Output Current (Max)	6.00A	4.74A	3.75A
Output Power	90W	90W	90W
Average Efficiency	88%	88%	88%
<b>INPUT</b>			
Input Voltage Range	90-264Vac		
Ripple & Noise	<1% (25°C at 10uF/0.47uF with 20MHz bandwidth)		
Load Regulation	±5%		
Leakage Current	<0.1mA normal condition, <0.3mA SFC at 264Vac/63Hz		
Input Frequency	47-63Hz		
<b>MECHANICAL</b>			
Dimensions (W × L × H)	60.00 × 150.00 × 35.00 mm (2.4 × 5.9 × 1.4 in)		
EMC & Emissions	EN 55011/EN 55032, FCC Title 47: Class B		
Connector Type	Input: C14 socket Output: 4-pin DIN/Barrel type/Tuning fork type		
Unit Weight	0.45 kg (0.99 lb)		
MTBF	1 million hours		
<b>ENVIRONMENT</b>			
Operating Temperature	0°C to +40°C		
Storage Temperature	-40°C to +85°C		
Operating Humidity	10-95% RH (Non-condensing)		
Operating Altitude	0-3,000 meters (0-9,840 feet)		
Protection Against Shock	Class I for F series, Class II with functional earth for B series		
<b>MEDICAL RATING</b>			
Float Rating	B		
MOPP	2 × MOPP		

unit: mm

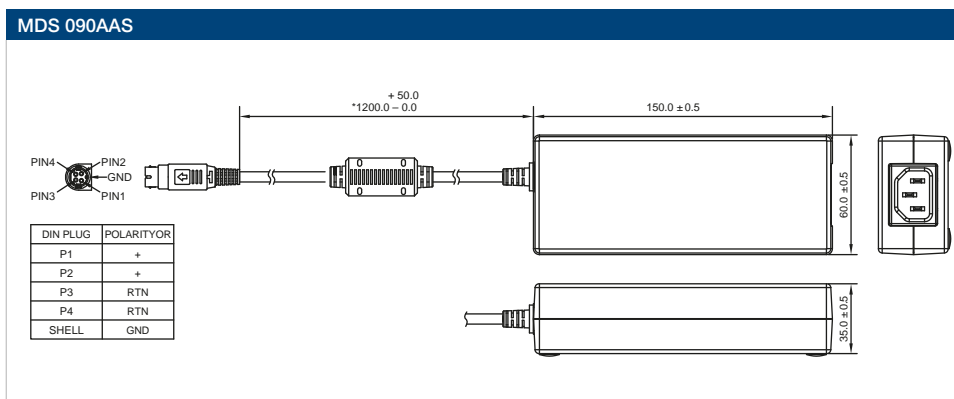

Open Frame Power Supply

Enclosed Power Supply

ATX Power Supply

Adapter Power Supply

# MDS 090BAS24 Adapter Power Supply

## 24V 90 WATTS



### HIGHLIGHTS & FEATURES

- Over-Voltage/Load/Temperature & Short Circuit Protections
- Low leakage current (<0.1mA Normal & <0.3mA single fault)
- Compliant with IEC 60601-1-2 4<sup>th</sup> Ed. Requirements
- Safety rated for medical and IT applications
- Risk management report available
- High isolation: 2 × MOPP
- 1 million hours MTBF
- 3 years warranty

### GENERAL SPECIFICATIONS

<b>OUTPUT</b>	090BAS24	
Output Voltage	24V	
Output Current (Max)	3.75A	
Output Power	90W	
Average Efficiency	88%	
<b>INPUT</b>		
Input Voltage Range	90-264Vac	
Ripple & Noise	<1% (25°C at 10uF/0.47uF with 20MHz bandwidth)	
Load Regulation	±5%	
Leakage Current	<0.1mA normal condition, <0.3mA SFC at 264Vac/63Hz	
Input Frequency	47-63Hz	
<b>MECHANICAL</b>		
Dimensions (W × L × H)	75.00 × 150.00 × 40.00 mm (3.0 × 5.9 × 1.6 in)	
EMC & Emissions	EN 55011/EN 55032, FCC Title 47: Class B	
Connector Type	Input: C8 socket Output: 4-pin DIN/Barrel type/Tuning fork type	
Unit Weight	0.50 kg (1.10 lb)	
MTBF	1 million hours	
<b>ENVIRONMENT</b>		
Operating Temperature	0°C to +40°C	
Storage Temperature	-40°C to +85°C	
Operating Humidity	10-95% RH (Non-condensing)	
Operating Altitude	0-5,000 meters (0-16,400 feet)	
Degree of Protection	IP22	
Protection Against Shock	Class II	
<b>MEDICAL RATING</b>		
Float Rating	BF	
MOPP	2 × MOPP	

unit: mm

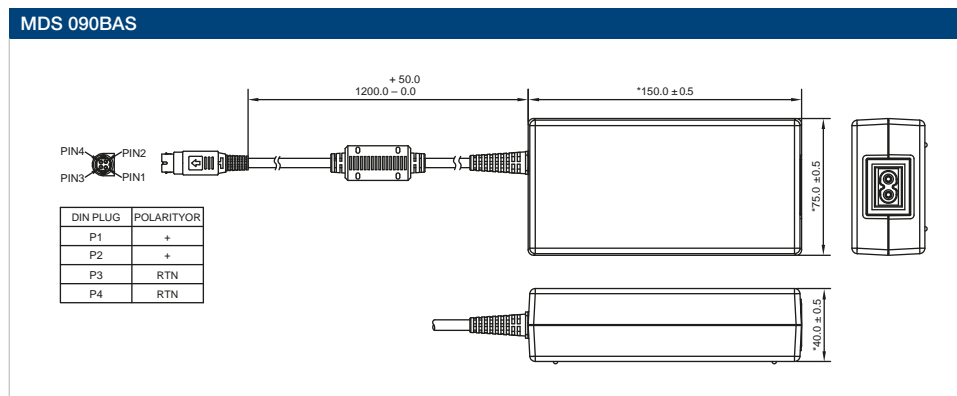

# MDS 150AAS Adapter Power Supply

## 12/19/24V 150 WATTS



### HIGHLIGHTS & FEATURES

- Over-Voltage/Load/Temperature & Short Circuit Protections
- Low leakage current (<0.1mA Normal & 0.3mA single fault)
- Compliant with IEC 60601-1-2 4<sup>th</sup> Ed. Requirements
- Safety approvals for medical and IT applications
- MDS-150AAS19 meet DOE Level VI & ErP 2017
- MDS-150AAS12, 24 meet DOE Level VI
- 1 million hours MTBF
- 2 × MOPP isolation
- 3 years warranty

### GENERAL SPECIFICATIONS

OUTPUT	150AAS12	150AAS19	150AAS24
Output Voltage	12V	19V	24V
Output Current (Max)	10.00A	7.89A	6.25A
Output Power	120W	150W	150W
Average Efficiency	88%	88%	88%
<b>INPUT</b>			
Input Voltage Range	90-264Vac		
Ripple & Noise	<1% (25°C at 10uF/0.47uF with 20MHz bandwidth)		
Load Regulation	±5%		
Leakage Current	<0.1mA normal condition, <0.3mA SFC at 264Vac/63Hz		
Input Frequency	47-63Hz		
<b>MECHANICAL</b>			
Dimensions (W × L × H)	85.00 × 170.00 × 40.00 mm (3.4 × 6.7 × 1.6 in)		
EMC & Emissions	EN 55011/EN 55032, FCC Title 47: Class B		
Connector Type	Input: C14 socket Output: 4-pin DIN/Barrel type/Tuning fork type (Select the appropriate DC plug according to the current)		
Unit Weight	1.10 kg (2.43 lb)		
MTBF	1 million hours		
<b>ENVIRONMENT</b>			
Operating Temperature	0°C to +40°C		
Storage Temperature	-40°C to +85°C		
Operating Humidity	10-95% RH (Non-condensing)		
Operating Altitude	0-3,000 meters (0-9,840 feet)		
Protection Against Shock	Class I for F series, Class II with functional earth for B series		
<b>MEDICAL RATING</b>			
Float Rating	B		
MOPP	2 × MOPP		

unit: mm

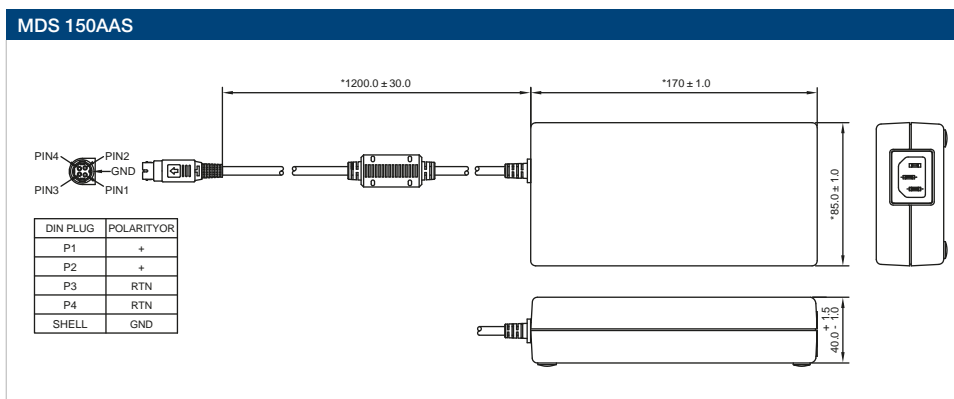

Open Frame Power Supply

Enclosed Power Supply

ATX Power Supply

Adapter Power Supply

# MDS 150CAB19 Adapter Power Supply

## 19V 150 WATTS



### HIGHLIGHTS & FEATURES

- Over-Voltage/Load/Temperature & Short Circuit Protections
- Safety rated for medical and IT applications
- 90-264 Vac universal input
- 2.1 million hours MTBF
- 2 × MOPP isolation
- 3 years warranty

### GENERAL SPECIFICATIONS

<b>OUTPUT</b>	150CAB19	
Output Voltage	19V	
Output Current (Max)	7.90A	
Output Power	150W	
Average Efficiency	88%	
<b>INPUT</b>		
Input Voltage Range	90-264Vac	
Ripple & Noise	<1% (25°C at 10uF/0.47uF with 20MHz bandwidth)	
Load Regulation	±5%	
Leakage Current	<0.1mA normal condition, <0.3mA SFC at 264Vac/63Hz	
Input Frequency	47-63Hz	
<b>MECHANICAL</b>		
Dimensions (W × L × H)	65.00 × 150.00 × 32.00 mm (2.6 × 5.9 × 1.3 in)	
EMC & Emissions	EN 55011/EN 55032, FCC Title 47: Class B	
Connector Type	Input: C6 socket Output: 4-pin DIN/Tuning fork type	
Unit Weight	0.52 kg (1.15 lb)	
MTBF	2.1 million hours	
<b>ENVIRONMENT</b>		
Operating Temperature	0°C to +40°C	
Storage Temperature	-40°C to +85°C	
Operating Humidity	10-95% RH (Non-condensing)	
Operating Altitude	0-5,000 meters (0-16,400 feet)	
Degree of Protection	IP22	
Protection Against Shock	Class I	
<b>MEDICAL RATING</b>		
Float Rating	B	
MOPP	2 × MOPP	

unit: mm

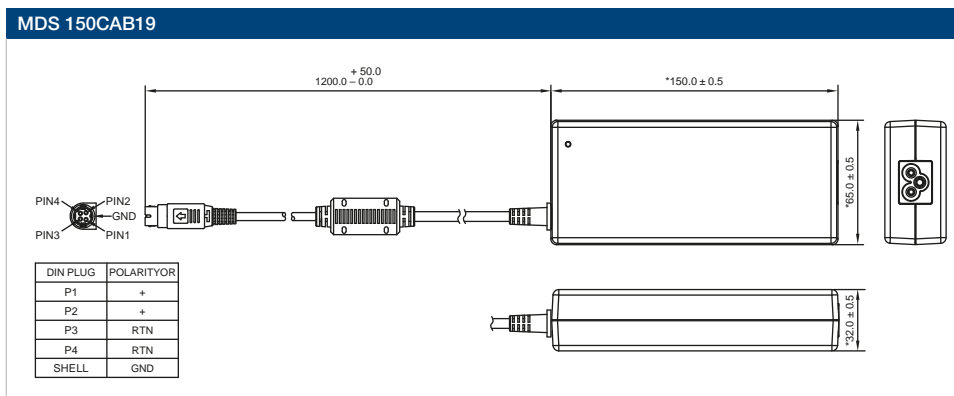

# Standards & Approvals

## Delta Standard Medical Power Supplies

	CE	CB Scheme to IEC 60601-1	CB Scheme to IEC 60950-1	UL 60601-1	UL 60950-1	CQC (China)	CCC (China)	TUV to EN 60601-1	TUV to EN 60950-1	EN 55011 Class B (Emissions)	EN 55032 Class B (Emissions)
<b>Open Frame Power Supply</b>											
MDS-040APS12 B	●	●	●	●	●	●	●			●	●
MDS-040APS15 B	●	●	●	●	●	●	●			●	●
MDS-040APS18 B	●	●	●	●	●	●	●			●	●
MDS-040APS24 B	●	●	●	●	●	●	●			●	●
MDS-065APS12 B	●	●	●	●	●	●				●	●
MDS-065APS15 B	●	●	●	●	●	●				●	●
MDS-065APS18 B	●	●	●	●	●	●				●	●
MDS-065APS24 B	●	●	●	●	●	●				●	●
MDS-100AP401 B	●	●	●	●	●	●				●	●
MDS-100APS12 B	●	●	●	●	●	●		●		●	●
MDS-100APS15 B	●	●	●	●	●	●				●	●
MDS-100APS18 B	●	●	●	●	●	●				●	●
MDS-100APS24 B	●	●	●	●	●	●				●	●
MDS-100BPS12 B	●	●	●	●	●	●				●	●
MDS-100BPS15 B	●	●	●	●	●	●				●	●
MDS-100BPS18 B	●	●	●	●	●	●				●	●
MDS-100BPS24 B	●	●	●	●	●	●				●	●
MDS-200APB12	●	●	●	●	●		●	●	●	●	●
MDS-200APB24	●	●	●	●	●		●	●	●	●	●
MDS-250APB12	●	●	●	●	●		●	●	●	●	●
MDS-250APB24	●	●	●	●	●		●	●	●	●	●
MDS-300APB12	●	●	●	●	●		●	●	●	●	●
MDS-300APB18	●	●	●	●	●		●	●	●	●	●
MDS-300APB24	●	●	●	●	●		●	●	●	●	●
MDS-300APB48	●	●	●	●	●		●	●	●	●	●
MDS-400APB12	●	●	●	●	●		●	●	●	●	●
MDS-400APB24	●	●	●	●	●		●	●	●	●	●
MDS-400AUS19 B	●	●	●	●	●		●	●	●	●	●
MDS-400AUS24 B	●	●	●	●	●		●	●	●	●	●
MEU-600C24T	●	●	●	●	●		●	●	●	●	●
<b>Enclosed Power Supply</b>											
MDS-200ADB12	●	●	●	●	●		●	●	●	●	●
MDS-200ADB24	●	●	●	●	●		●	●	●	●	●
MDS-250ADB12	●	●	●	●	●		●	●	●	●	●
MDS-250ADB24	●	●	●	●	●		●	●	●	●	●
MDS-300ADB12	●	●	●	●	●		●	●	●	●	●
MDS-300ADB18	●	●	●	●	●		●	●	●	●	●
MDS-300ADB24	●	●	●	●	●		●	●	●	●	●
MDS-400ADB12	●	●	●	●	●		●	●	●	●	●
MDS-400ADB24	●	●	●	●	●		●	●	●	●	●
MDS-300ADB48	●	●	●	●	●		●	●	●	●	●
MEB-1K2A24T	●	●	●	●	●		●	●	●	●	●

# Standards & Approvals

## Delta Standard Medical Power Supplies

	CE	CB Scheme to IEC 60601-1	CB Scheme to IEC 60950-1	UL 60601-1	UL 60950-1	CQC (China)	CCC (China)	TUV to EN 60601-1	TUV to EN 60950-1	EN 55011 Class B (Emissions)	EN 55032 Class B (Emissions)
ATX Power Supply											
MDS-040APS12 B	●	●	●	●	●		●				
Adapter Power Supply											
MDS-005AAS05 A	●	●		●			●			●	●
MDS-005AAS05 B	●	●		●						●	●
MDS-005AAS05 C	●	●								●	●
MDS-005AAS06 A	●	●					●				
MDS-005AAS06 B	●	●		●						●	●
MDS-005AAS06 C	●	●								●	●
MDS-030AAC05	●	●		●			●			●	●
MDS-030AAC07	●	●		●			●			●	●
MDS-030AAC12	●	●		●			●			●	●
MDS-030AAC15	●	●		●			●			●	●
MDS-030AAC24	●	●		●			●			●	●
MDS-060AAS12 B	●	●		●			●			●	●
MDS-060AAS15 B	●	●		●			●			●	●
MDS-060AAS19 B	●	●		●			●			●	●
MDS-060AAS24 B	●	●		●			●			●	●
MDS-060BAS12 A	●	●		●			●			●	●
MDS-060BAS19 A	●	●		●			●			●	●
MDS-060BAS24 A	●	●		●			●			●	●
MDS-080AAS12 A	●	●		●			●			●	●
MDS-090AAS15 B	●	●		●			●			●	●
MDS-090AAS19 B	●	●		●			●			●	●
MDS-090AAS24 B	●	●		●			●			●	●
MDS-090BAS24 A	●	●		●			●			●	●
MDS-150AAS12 B	●	●		●			●			●	●
MDS-150AAS19 B	●	●		●			●			●	●
MDS-150AAS24 B	●	●		●			●			●	●
MDS-150CAB19	●	●		●			●			●	●



## Warranty

Delta warrants that the products (“Products”) sold in this catalog will be free of defects in material and workmanship within the warranty period. The warranty does not apply to Products which have been subjected to abuse, misuse, accident, neglect, unauthorized and/or improper installation, operation, use, maintenance, repair or alteration, or accident of unusual deterioration or degradation of the Products or parts thereof due to physical environment beyond the requirements of the Product specifications.

## Attention

- Delta will do our utmost in ensuring the accuracy of all information provided in the catalog and datasheets that are officially released and published. However, there may be instance where discrepancy occurs between the catalog and the datasheets. When such case happens, kindly refer to **[www.DeltaPSU.com](http://www.DeltaPSU.com)** for the latest catalog and datasheets where the datasheets shall take precedence over the catalog information.
- In our constant pursuit for product and quality excellence to fulfill market and customer demands, Delta shall reserve the rights to revise and update any information in this catalog without prior notification.

## EMC Directives

At Delta, all of our products are designed to meet the highest quality standards. All national and international safety certifications including EMC directives are conducted by qualified and independent laboratories. For EMC directives’ compliance, the power supplies are tested to ensure compliance as a stand-alone product. Power supplies like the open frame and adapter types are typically considered component power supply. Therefore, Delta cannot guarantee the system which is installed with Delta’s component power supply can meet the related EMC directives. Customers are advised to contact the system manufacturer for confirmation.

## Availability

Products with “New” tab are slated for official release with immediate effect, while products with “Coming Soon” tab will be available within the next two months from this catalog’s publication month (Refer to cover page). Kindly contact your local Delta distributor for availability, ordering and delivery details. You may also get in touch with us via the Feedback Form on **[www.deltapsu.com/feedback](http://www.deltapsu.com/feedback)**.

---

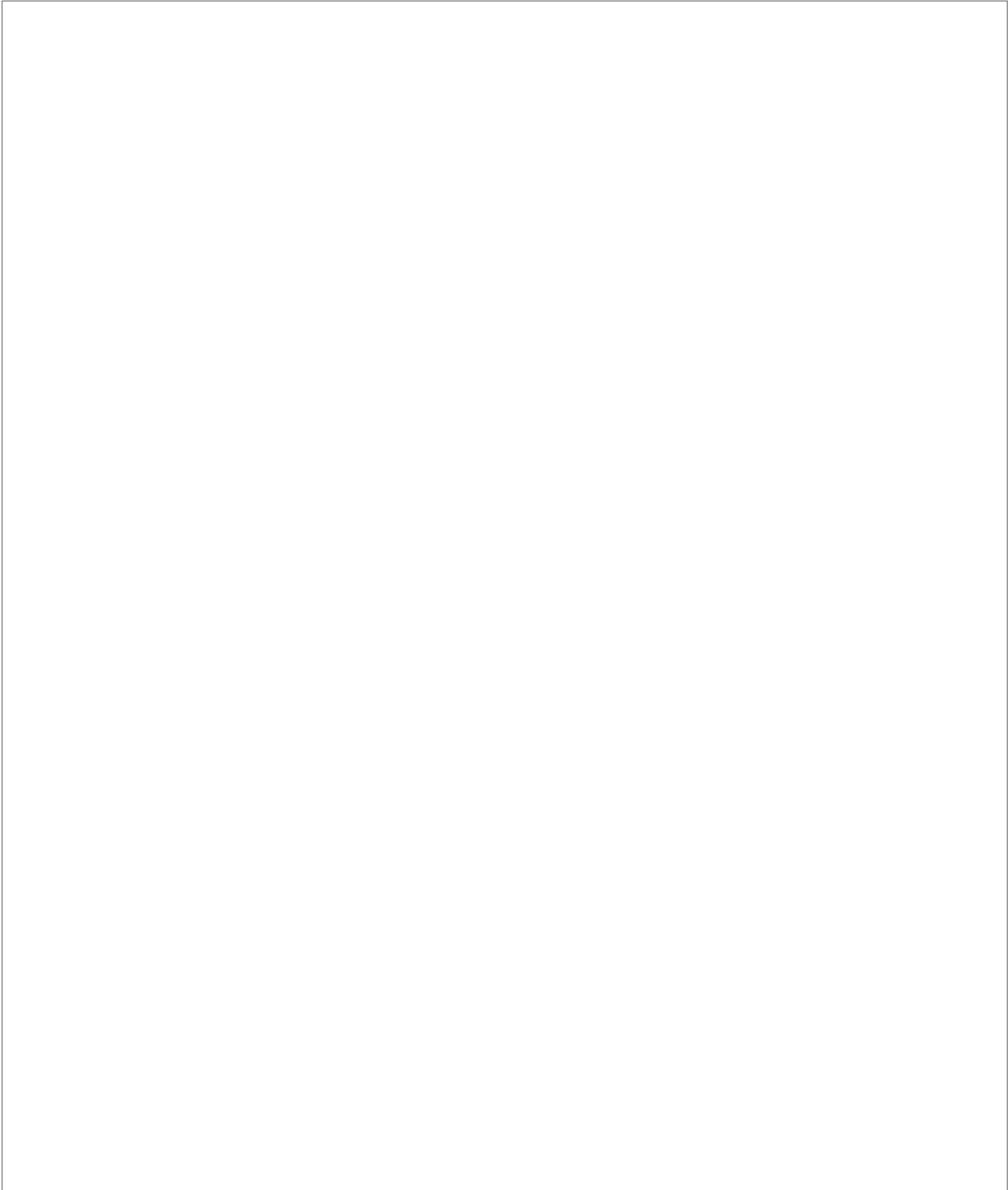



## ASIA

### Delta Electronics, Inc.

3 Tungyuan Road, Chungli Industrial Zone,  
Taoyuan County 32063, Taiwan, R.O.C

Tel: +886 3 452 6107  
Fax: +886 3 434 3617

### Delta Electronics (Shanghai) Co., Ltd. Headquarters

No. 182 Minyu Road, Pudong,  
Shanghai, P.R.C. 201209

Tel: +86 21 68723988  
Fax: +86 21 68723996

### Delta Electronics (Shanghai) Co., Ltd. Beijing Branch

No. 7 Building, 6th Courtyard, Beichen East Rd.,  
Chaoyang Dist., Beijing, P.R.C. 100105

Tel: +86 10 82253225  
Fax: +86 10 82251360

### Delta Electronics (Thailand) PCL.

909 Soi 9, Moo 4, Bangpoo Industrial Estate  
(E.P.Z.), Pattana 1 Rd., T. Phrakasa, A. Muang,  
Samutprakarn 10280, Thailand

Tel: +662 709 2800  
Fax: +662 709 2827

### Delta India Electronics Pvt. Ltd.

Plot No. 43, Sector - 35, HSIIDC,  
Gurgaon, Haryana 122001

Tel: +91 124 4874900  
+91 124 4169040  
Fax: +91 124 4874945

### Delta Electronics (Japan), Inc.

2-1-14 Shibadaimon, Minato-Ku,  
Tokyo, 105-0012, Japan

Tel: +81 3 5733 1155  
Fax: +81 3 5733 1255

### Delta Electronics (Korea), Inc.

1511, Byucksan Digital Valley 6-Cha,  
Gasan-dong, Geumcheon-gu,  
Seoul, 153-704, Korea

Tel: +82 2 515 5303  
+82 2 515 5305  
Fax: +82 2 515 5302

## NORTH AMERICA

### Delta Products Corporation North American Headquarters

46101 Fremont Blvd.  
Fremont, CA 94538, U.S.A.  
Tel: +1 510 668 5100

## CENTRAL AND SOUTH AMERICA

### Delta Greentech (Brasil) S.A.

Rua Itapeva, 26 - 3º, andar Edifício Itapeva,  
One - Bela Vista 01332-000 - São Paulo - SP -  
Brasil

Tel: +55 11 3568 3850  
Fax: +55 11 3568 3865

### Delta Electronics International Mexico, S.A. de C.V.

Via Dr. Gustavo Baz No. 2160,  
Fracc. Ind. La Loma, Tlalnepantla de Baz,  
Estado de México, 54060, Mexico

Tel: +52 55 2628 3015

## EUROPE

### Delta Electronics (Netherlands) B.V. EMEA Headquarters

Zandsteen 15  
2132 MZ Hoofddorp, The Netherlands  
Tel: +31 20 655 0975  
Fax: +31 20 655 0999

Authorized Distributor:

[www.DeltaPSU.com](http://www.DeltaPSU.com) | [info@deltapsu.com](mailto:info@deltapsu.com)

July 2017 (Rev. 01) - All information and specifications are subject to change without prior notice.

## X-ON Electronics

Largest Supplier of Electrical and Electronic Components

*Click to view similar products for [Switching Power Supplies](#) category:*

*Click to view products by [Delta](#) manufacturer:*

Other Similar products are found below :

[70841011](#) [73-551-0005](#) [73-551-0048](#) [PS3E-B12F](#) [PS3E-E12F](#) [AAD600S-4-OP](#) [R22095](#) [KD0204](#) [9021](#) [LDIN100150](#) [LPM000-BBAR-01](#)  
[LPX17S-C](#) [EVS57-10R6/R](#) [FP80](#) [FRV7000G](#) [22929](#) [PS3E-F12F](#) [CQM1IA121](#) [40370121900](#) [VI-PU22-EXX](#) [40370121910](#) [LDIN5075](#)  
[LPM615-CHAS](#) [LPX140-C](#) [09-160CFG](#) [70841025](#) [VPX3000-CBL-DC](#) [VI-LUL-IU](#) [LPM000-BBAR-05](#) [LPM000-BBAR-08](#) [LPM124-](#)  
[OUTA1-48](#) [LPM000-BBAR-07](#) [LPM109-OUTA1-10](#) [LPM616-CHAS](#) [08-30466-1055G](#) [08-30466-2175G](#) [08-30466-2125G](#) [DMB-EWG](#)  
[TVQF-1219-18S](#) [6504-226-2101](#) [CQM1IPS01](#) [SP-300-5](#) [CQM1-IPS02](#) [VI-MUL-ES](#) [22829](#) [08-30466-0065G](#) [VI-RU031-EWWX](#) [08-30466-](#)  
[0028G](#) [EP3000AC48INZ](#) [VP-C2104853](#)