



Digitized Automation for a Changing World

# Delta Sensorless Vector Control Compact Drive VFD-EL Series



[www.deltaww.com](http://www.deltaww.com)

 **DELTA**  
Smarter. Greener. Together.

# Features

▶ **Standard Modbus Protocol**

Standard Modbus protocol via RS-485

▶ **Built-in EMC Filter  
(230V single-phase and 460V 3-phase)**

The built-in EMC filter reduces electromagnetic interference and complies with the EN61800-3 standard

▶ **Compact Design**

Space saving and easy DIN rail mounting with optional DIN rail adapter (Built-in for Frame B)

▶ **Optional Fieldbus Modules**

Provide connection to a variety of networks, including PROFIBUS, DeviceNet and CANopen

▶ **RFI Switch for IT Mains**

Removable "Y" capacitor to use with IT mains supplies



▶ **DC Bus Sharing**

Multiple VFD-EL can be connected in parallel to share the regenerative braking energy. This prevents over-voltage and stabilizes DC bus voltage.

\*This function is not supported by the 115V model.

▶ **Complete Protection Functions**

High precision current detection, full overload protection (oL, oL1 and oL2), overvoltage/overcurrent stall prevention, short-circuit protection, reset after fault, speed search function and motor overheat protection by PTC

▶ **Power Range**

Single-phase 115V series: 0.2~0.75kW (0.25~1 hp)

Single-phase 230V series: 0.2~2.2kW (0.25~3 hp)

3-phase 230V series: 0.2~3.7kW (0.25~5 hp)

3-phase 460V series: 0.4~3.7kW (0.50~5 hp)

▶ **Side-by-side Installation (40°C)**

High-efficiency cooling and flexible spacing



▶ **Easy Maintenance**

Removable cooling fan for easy maintenance



## Applications

### ► Conveyor Belts

1. Multi-step speed application: provides multi-step speed settings to meet the needs of a conveyor belt
2. Side-by-side installation to save space
3. DC bus sharing: connects multiple drives in parallel to share the regenerative energy and prevent overvoltage



### ► Winders

Auto acceleration/deceleration function provides rapid start/stop of operation and increases productivity and efficiency

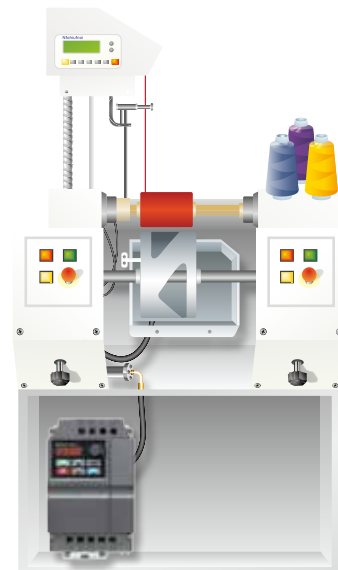

### ► Constant Pressure Control of Water Pumps

1. Built-in smart PID controller saves the cost of a specified external PID meter
2. Built-in auto detection of water suspension and auto power-on saves the cost of external PLC controller and relay
3. A wide range of input voltages are available, including single-phase 110V/230V and 3-phase 230V/460V, for various pump applications and different countries

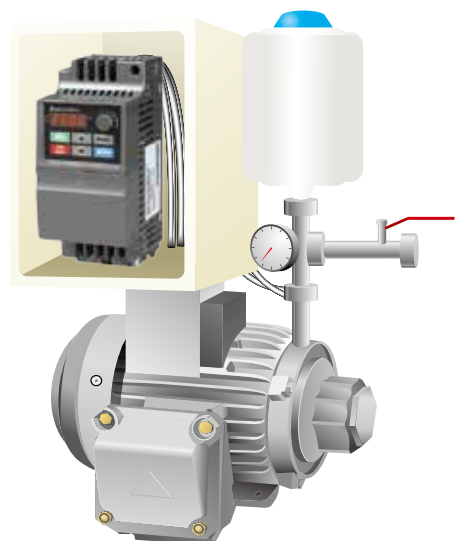

# Standard Wiring Diagram

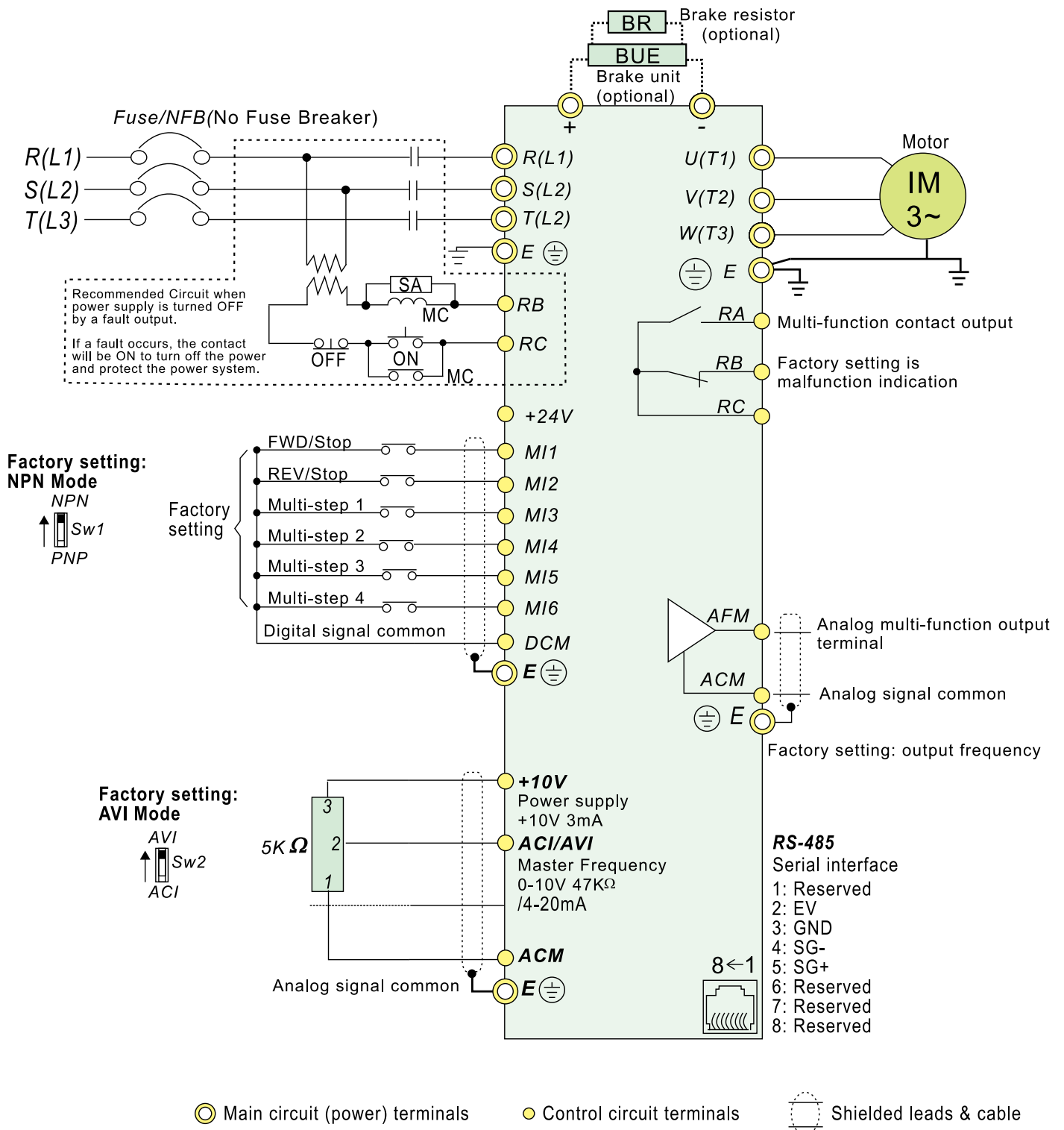

## NOTE

It is recommended to install circuit breaker at the control terminal to protect the circuit from operation abnormality or sudden power outage.

The protection circuit uses the multi-function output terminal of the AC motor drive for connection. When an abnormal condition (closed contact) occurs, the external power supply is disconnected to protect the power system of the AC motor drive.

## External Parts

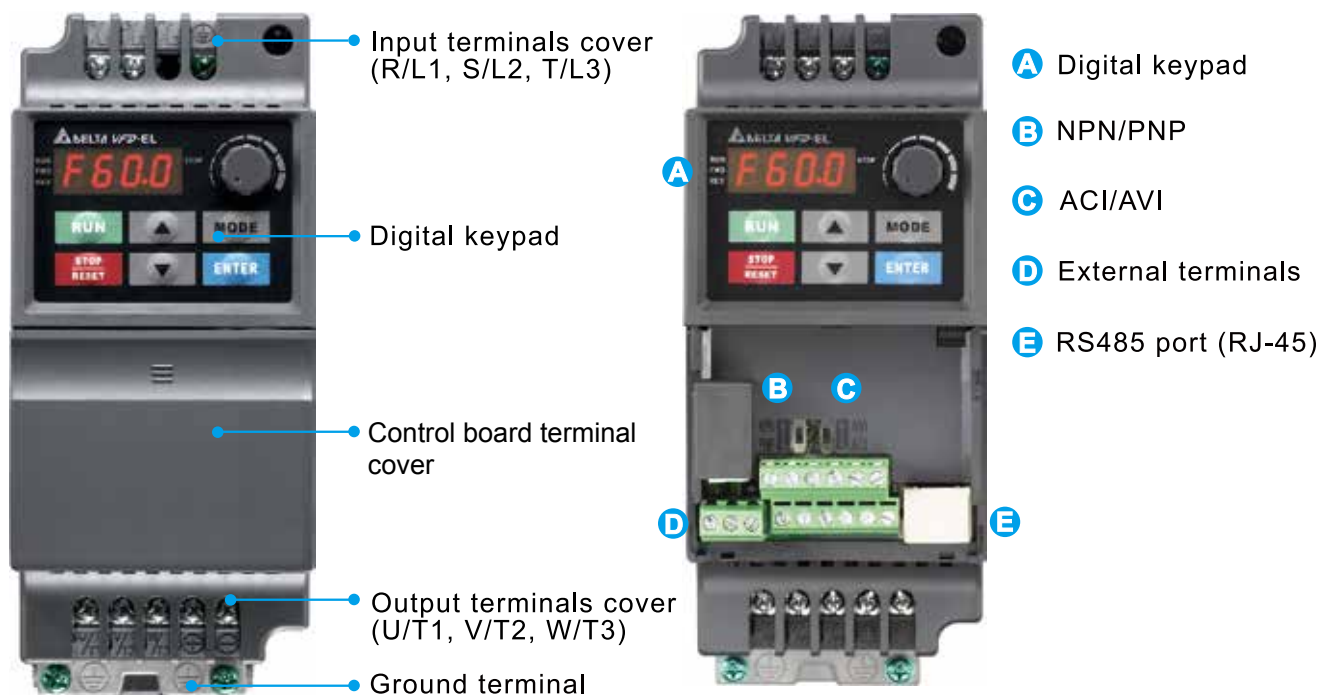

## Control Terminals

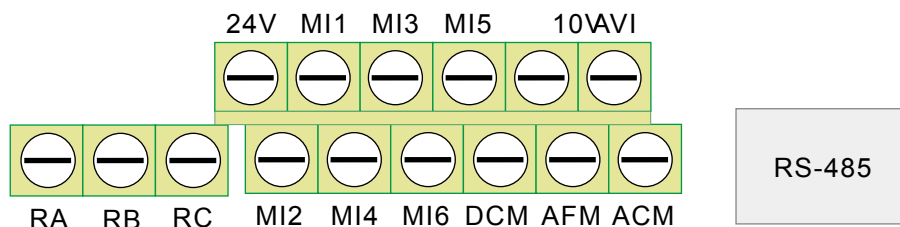

## Model Explanation

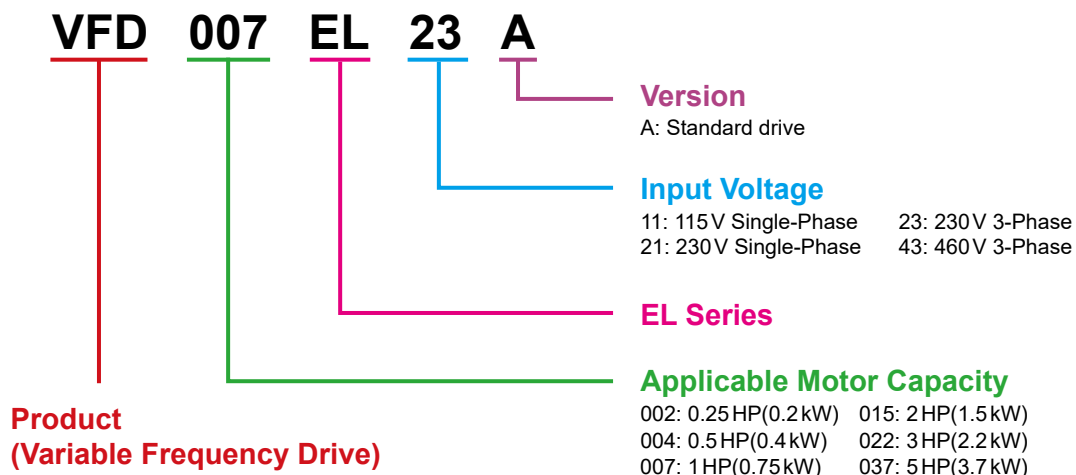

# Application Fields

## Conveyor and Transportation Machinery

- Conveyor belt
- Automatic door
- Roller door
- Small elevator
- Escalator
- X,Y-axis traveling crane

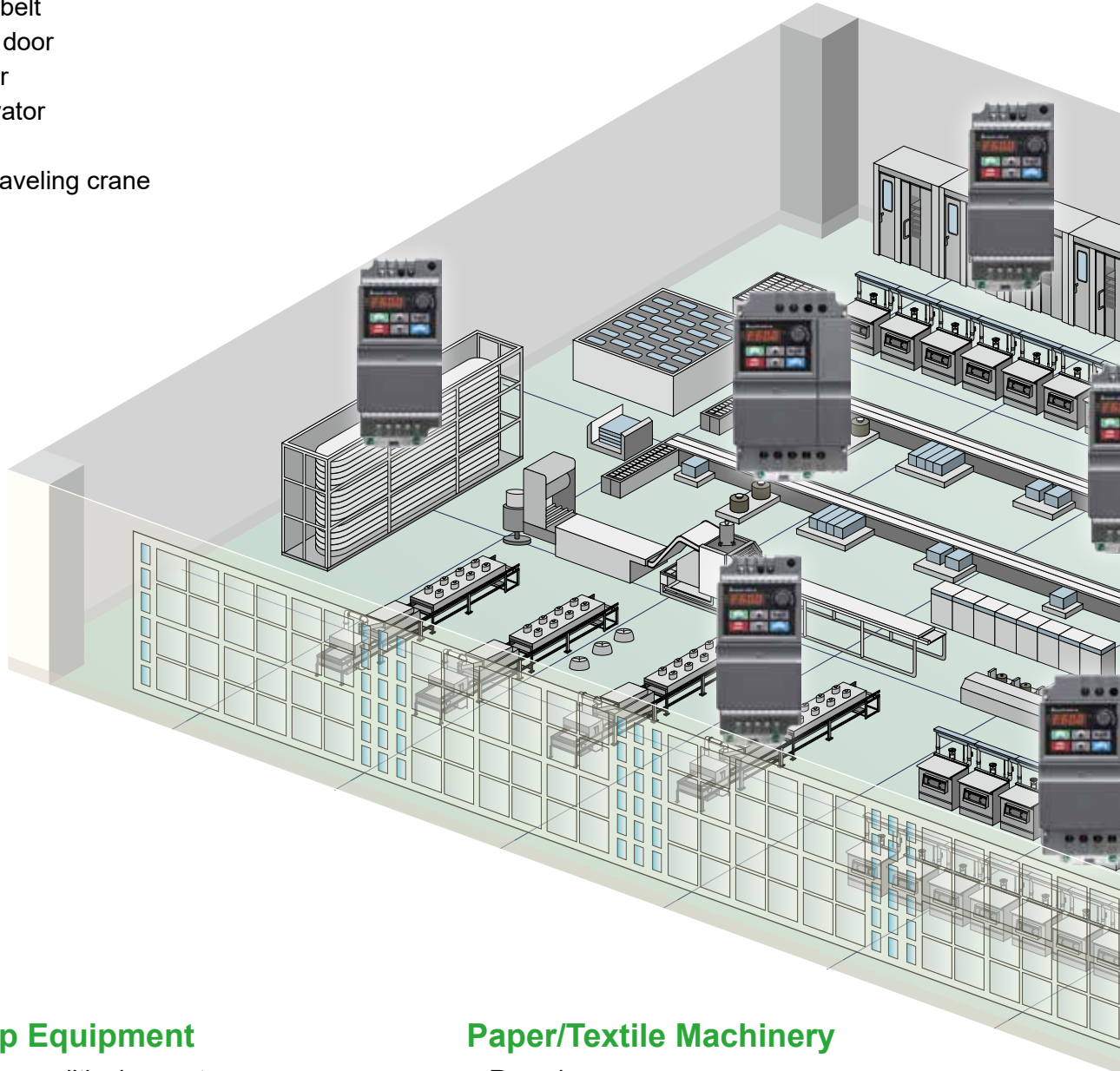

## Fan/Pump Equipment

- Building air conditioning system
- Wastewater processing system
- Constant pressure water treatment system
- Water treatment pump
- Agricultural pump
- Temperature control of mid and larger oven
- Air compressor
- Heat exchange fan
- Building water dispenser system
- Dryer's windmill

## Paper/Textile Machinery

- Round weaver
- Cross weaver
- Ribbon weaver
- Printing press
- Industrial sewing machine
- Knitting machine

## Food Processing

- Dumpling making machine
- Food mixer
- Noodle making machine

## Wood Working Machinery

- 4 side planer
- Wood carving machine
- Woodworking machine
- Simple cutting machine for wood working
- Spraying machine

## Machine Tool/Metal Processing Machinery

- Grinding machine
- Drilling machine
- Small lathe
- Milling machine
- Injection molding (clamp)

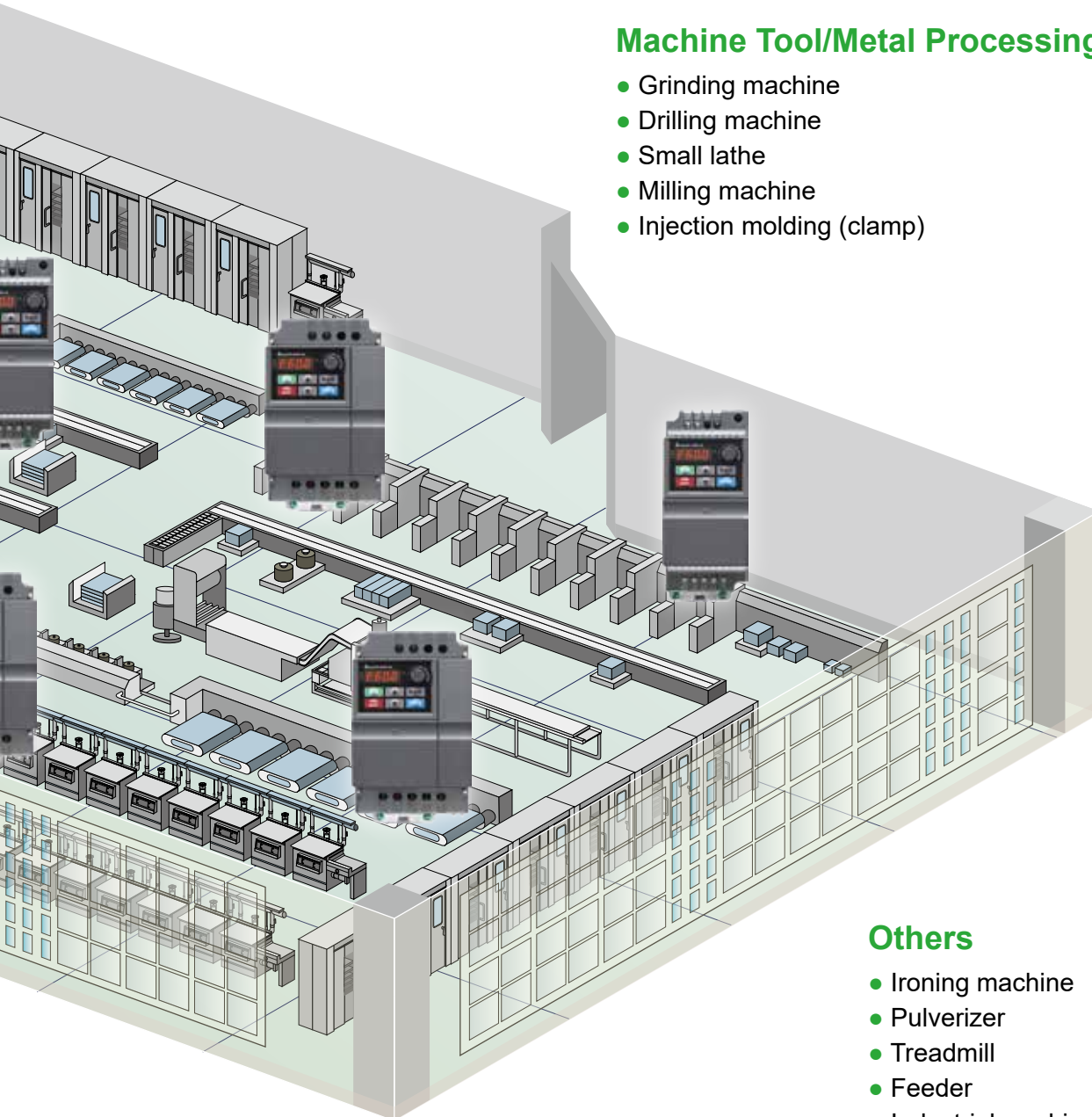

## Others

- Ironing machine
- Pulverizer
- Treadmill
- Feeder
- Industrial washing machine
- Car washing machine
- Packing machine
- Centrifuge
- Liquid mixing machine



# Specifications

115V	Voltage Class	115V		
	Model Number VFD-___ EL	002	004	007
	Max. Applicable Motor Output (kW)	0.2	0.4	0.75
	Max. Applicable Motor Output (Hp)	0.25	0.5	1.0
Output Rating	Rated Output Capacity (kVA)	0.6	1.0	1.6
	Rated Output Current (A)	1.6	2.5	4.2
	Maximum Output Voltage (V)	3-phase proportional to twice the input voltage		
	Output Frequency (Hz)	0.1~599Hz		
	Carrier Frequency (kHz)	2~12		
Input Rating	Rated Input Current (A)	Single-phase		
		6.4	9	18
	Rated Voltage/Frequency	Single-phase 100~120V, 50/60Hz		
	Voltage Tolerance	±10% (90~132V)		
	Frequency Tolerance	±5% (47~63Hz)		
	Cooling Method	Natural cooling		
	Weight (kg)	1.1	1.1	1.4

230V	Voltage Class	230V						
	Model Number VFD-___ EL	002	004	007	015	022	037	
	Max. Applicable Motor Output (kW)	0.2	0.4	0.75	1.5	2.2	3.7	
	Max. Applicable Motor Output (Hp)	0.25	0.5	1.0	2.0	3.0	5.0	
Output Rating	Rated Output Capacity (kVA)	0.6	1.0	1.6	2.9	4.2	6.5	
	Rated Output Current (A)	1.6	2.5	4.2	7.5	11.0	17.0	
	Maximum Output Voltage (V)	3-phase proportional to input voltage						
	Output Frequency (Hz)	0.1~599Hz						
	Carrier Frequency (kHz)	2~12						
Input Rating	XXXE L21A	Rated Input Current (A)	4.9	6.5	9.5	15.7	24	--
		Rated Voltage/Frequency	Single-phase, 200~240V, 50/60Hz					
	XXXE L23A	Rated Input Current (A)	1.9	2.7	4.9	9	15	20.6
		Rated Voltage/Frequency	Single-phase/3-phase, 200~240V, 50/60Hz					
	Voltage Tolerance	±10% (180~264V)						
	Frequency Tolerance	±5% (47~63Hz)						
	Cooling Method	Natural cooling	Fan cooling (XXXEL21A) Natural cooling (XXXEL23A)		Fan cooling			
	Weight (kg)	1.2	1.2	1.2	1.7	1.7	1.7	

460V	Voltage Class	460V				
	Model Number VFD-___ EL	004	007	015	022	037
	Max. Applicable Motor Output (kW)	0.4	0.75	1.5	2.2	3.7
	Max. Applicable Motor Output (hp)	0.5	1.0	2.0	3.0	5.0
Output Rating	Rated Output Capacity (kVA)	1.2	2.0	3.3	4.4	6.8
	Rated Output Current (A)	1.5	2.5	4.2	5.5	8.2
	Maximum Output Voltage (V)	3-phase proportional to input voltage				
	Output Frequency (Hz)	0.1~599 Hz				
	Carrier Frequency (kHz)	2~12				
Input Rating	Rated Input Current (A)	3-phase				
		1.8	3.2	4.3	7.1	9.0
	Rated Voltage/Frequency	3-phase, 380~480V, 50/60Hz				
	Voltage Tolerance	±10% (342~528V)				
	Frequency Tolerance	±5% (47~63Hz)				
	Cooling Method	Natural cooling		Fan cooling		
	Weight (kg)	1.2	1.2	1.2	1.7	1.7



Control Characteristics	<b>Control System</b>		SPWM (Sinusoidal Pulse Width Modulation) control (V/F control)
	<b>Frequency Setting Resolution</b>		0.01 Hz
	<b>Output Frequency Resolution</b>		0.01 Hz
	<b>Torque Characteristics</b>		Including the auto-torque/auto-slip compensation; starting torque can be 150 % at 5.0Hz
	<b>Overload Endurance</b>		150% of rated current for 1 minute
	<b>Skip Frequency</b>		Three zones, setting range 0.1 ~ 599Hz
	<b>Accel/Decel Time</b>		0.1 to 600 seconds (2 Independent settings for Accel/Decel time)
	<b>Stall Prevention Level</b>		Setting 20 to 250 % of rated current
	<b>DC Braking</b>		Operation frequency 0.1 ~ 599 Hz, output 0 ~ 100 % rated current Start time 0 ~ 60 seconds, stop time 0 ~ 60 seconds
	<b>Regenerated Braking Torque</b>		Approx. 20% (up to 125 % possible with optional brake resistor)
	<b>V/F Pattern</b>		Adjustable V/F pattern
Operating Characteristics	<b>Frequency Setting</b>	<b>Keypad</b>	Setting by ▲ ▼
		<b>External Signal</b>	Potentiometer 5k/0.5W, 0 to +10V <sub>DC</sub> , 4 to 20 mA, RS-485 interface; Multi-function Inputs 3 to 6 (15 steps, Jog, up/down)
	<b>Operation Setting Signal</b>	<b>Keypad</b>	Set by RUN and STOP
		<b>External Signal</b>	2 wires/3 wires (MI1, MI2, MI3), JOG operation, RS-485 serial interface (Modbus)
	<b>Multi-function Input Signal</b>		Multi-step selection 0 to 15, Jog, accel / decel inhibit, 2 accel / decel switches, counter, external Base Block, ACI/AVI selections, driver reset, UP/DOWN key settings, NPN/PNP input selection
	<b>Multi-function Output Indication</b>		AC drive operating, frequency attained, counter attained, zero speed, Base Block, fault indication, overheat alarm, emergency stop and status selections of input terminals
	<b>Analog Output Signal</b>		Output frequency / current
<b>Alarm Output Contact</b>		Contact will be ON when drive malfunctions (1 Form C/change-over contact or 1 open collector output)	
<b>Operation Functions</b>		AVR, accel / decel S-Curve, overvoltage / overcurrent stall prevention, 5 fault records, reverse inhibition, momentary power loss restart, DC braking, auto torque / slip compensation, adjustable carrier frequency, output frequency limits, parameter lock / reset, PID control, external counter, MODBUS communication, abnormal reset, abnormal re-start, power-saving, fan control, sleep/wake frequency, 1st/2nd frequency source selections, 1st/2nd frequency source combination, NPN/PNP selection	
<b>Protection Functions</b>		Over voltage, over current, under voltage, external fault, overload, ground fault, overheating, electronic thermal, IGBT short circuit, PTC	
<b>Display Keypad</b>		6-key, 7-segment LED with 4-digit, 4 status LEDs, master frequency, output frequency, output current, custom units, parameter values for setup and lock, faults, RUN, STOP, RESET, FWD/REV	
<b>Built-in EMC Filter</b>		For 230V 1-phase and 460V 3-phase models	
Environmental Conditions	<b>Enclosure Rating</b>		IP20
	<b>Pollution Degree</b>		2
	<b>Installation Location</b>		Altitude 1,000 m or lower, keep from corrosive gasses, liquid and dust
	<b>Ambient Temperature</b>		-10°C ~ 50°C (40°C for side-by-side mounting) non-condensing and not frozen
	<b>Storage/ Transportation Temperature</b>		-20°C ~ 60°C
	<b>Ambient Humidity</b>		Below 90 % RH (non-condensing)
	<b>Vibration</b>		9.80665 m/s <sup>2</sup> (1G) less than 20Hz, 5.88 m/s (0.6 G) at 20 ~ 50Hz
<b>Certifications</b>		  	

# Dimensions

## Frame A

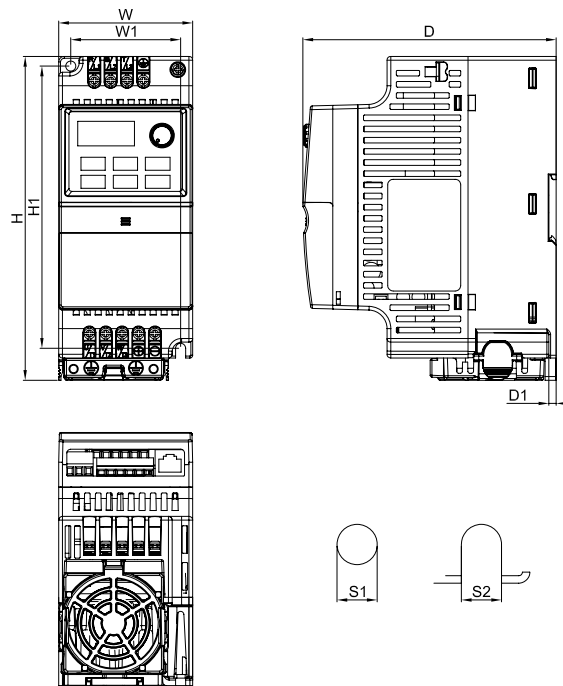

### MODEL

- VFD002EL11A
- VFD002EL21A
- VFD002EL23A
- VFD004EL11A
- VFD004EL21A
- VFD004EL23A
- VDF004EL43A
- VFD007EL21A
- VDF007EL23A
- VDF007EL43A
- VDF015EL23A
- VDF015EL43A

Unit: mm[inch]

Frame		W	H	D	W1	H1	D1	S1	S2
A	mm	72.0	174.0	136.0	59.0	151.6	4.0	5.4	5.4
	inch	2.83	6.86	5.36	2.32	5.97	0.16	0.21	0.21

## Frame B

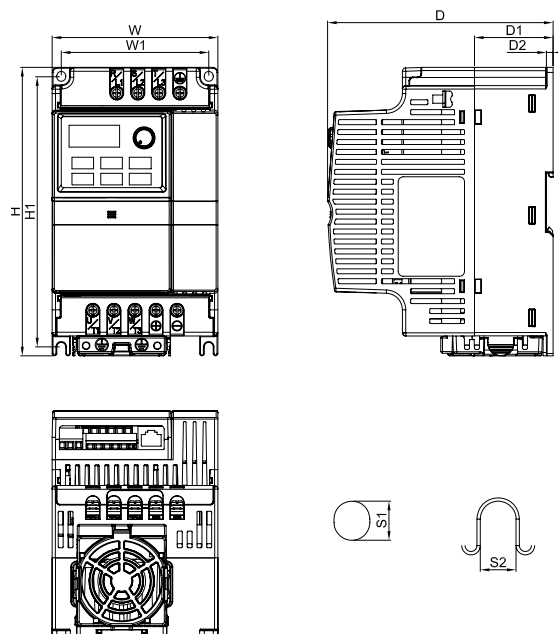

### MODEL

- VFD007EL11A
- VFD015EL21A
- VFD022EL21A
- VDF022EL23A
- VFD022EL43A
- VDF037EL23A
- VDF037EL43A

Unit: mm[inch]

Frame		W	H	D	W1	H1	D1	D2	S1	S2
B	mm	100.0	174.0	136.0	89.0	162.9	47.4	4.0	5.9	5.4
	inch	3.94	6.85	5.36	3.50	6.42	1.87	0.16	0.23	0.21

# Accessories

## Fieldbus Modules



▪ **DeviceNet**  
CME-DN01



▪ **PROFIBUS**  
CME-PD01



▪ **CANopen**  
CME-COP01

## Others



▪ **Brake unit**  
BUE-20015    BUE-40015  
BUE-20037    BUE-40037



▪ **Communication keypad**  
VFD-PU06



▪ **DIN Rail (Width 35mm)**  
MKEL-DRA    MKEL-DRB



▪ **Brake resistor**





▪ **Zero phase reactor**  
RF220X00A



▪ **Grounding plate**  
MKE-EP

## Ordering Information

Frame Size	Power Range	Models
<b>Frame A</b> 	115V: 0.2 kW~0.4 kW 230V: 0.2 kW~1.5 kW 460V: 0.4 kW~1.5 kW	VFD002EL 11A / 21A / 23A VFD004EL 11A / 21A / 23A / 43A VFD007EL 21A / 23A / 43A VFD015EL 23A / 43A
<b>Frame B</b> 	115V: 0.75 kW 230V: 1.5 kW~3.7 kW 460V: 2.2 kW~3.7 kW	VFD007EL11A VFD015EL 21A VFD022EL 21A / 23A / 43A VFD037EL 23A / 43A



Smarter. Greener. Together.

## Industrial Automation Headquarters

### Taiwan: Delta Electronics, Inc.

Taoyuan Technology Center  
No.18, Xinglong Rd., Taoyuan District,  
Taoyuan City 33068, Taiwan  
TEL: +886-3-362-6301 / FAX: +886-3-371-6301

## Asia

### China: Delta Electronics (Shanghai) Co., Ltd.

No.182 Minyu Rd., Pudong Shanghai, P.R.C.  
Post code : 201209  
TEL: +86-21-6872-3988 / FAX: +86-21-6872-3996  
Customer Service: 400-820-9595

### Japan: Delta Electronics (Japan), Inc.

Industrial Automation Sales Department  
2-1-14 Shibadaimon, Minato-ku  
Tokyo, Japan 105-0012  
TEL: +81-3-5733-1155 / FAX: +81-3-5733-1255

### Korea: Delta Electronics (Korea), Inc.

1511, 219, Gasan Digital 1-Ro., Geumcheon-gu,  
Seoul, 08501 South Korea  
TEL: +82-2-515-5305 / FAX: +82-2-515-5302

### Singapore: Delta Energy Systems (Singapore) Pte Ltd.

4 Kaki Bukit Avenue 1, #05-04, Singapore 417939  
TEL: +65-6747-5155 / FAX: +65-6744-9228

### India: Delta Electronics (India) Pvt. Ltd.

Plot No.43, Sector 35, HSIIDC Gurgaon,  
PIN 122001, Haryana, India  
TEL: +91-124-4874900 / FAX: +91-124-4874945

### Thailand: Delta Electronics (Thailand) PCL.

909 Soi 9, Moo 4, Bangpoo Industrial Estate (E.P.Z),  
Pattana 1 Rd., T.Phraksa, A.Muang,  
Samutprakarn 10280, Thailand  
TEL: +66-2709-2800 / FAX: +66-2709-2827

### Australia: Delta Electronics (Australia) Pty Ltd.

Unit 20-21/45 Normanby Rd., Notting Hill Vic 3168, Australia  
TEL: +61-3-9543-3720

## Americas

### USA: Delta Electronics (Americas) Ltd.

5101 Davis Drive, Research Triangle Park, NC 27709, U.S.A.  
TEL: +1-919-767-3813 / FAX: +1-919-767-3969

### Brazil: Delta Electronics Brazil

Rua Itapeva, 26 - 3º, andar Edifício Itapeva,  
One - Bela Vista 01332-000 - São Paulo - SP - Brazil  
TEL: +55-12-3932-2300 / FAX: +55-12-3932-237

### Mexico: Delta Electronics International Mexico S.A. de C.V.

Gustavo Baz No. 309 Edificio E PB 103  
Colonia La Loma, CP 54060  
Tlalnepantla, Estado de México  
TEL: +52-55-3603-9200

## EMEA

### EMEA Headquarters: Delta Electronics (Netherlands) B.V.

Sales: Sales.IA.EMEA@deltaww.com  
Marketing: Marketing.IA.EMEA@deltaww.com  
Technical Support: iatechnicalsupport@deltaww.com  
Customer Support: Customer-Support@deltaww.com  
Service: Service.IA.emea@deltaww.com  
TEL: +31(0)40 800 3900

### BENELUX: Delta Electronics (Netherlands) B.V.

Automotive Campus 260, 5708 JZ Helmond, The Netherlands  
Mail: Sales.IA.Benelux@deltaww.com  
TEL: +31(0)40 800 3900

### DACH: Delta Electronics (Netherlands) B.V.

Coesterweg 45, D-59494 Soest, Germany  
Mail: Sales.IA.DACH@deltaww.com  
TEL: +49(0)2921 987 0

### France: Delta Electronics (France) S.A.

ZI du bois Challand 2, 15 rue des Pyrénées,  
Lisses, 91090 Evry Cedex, France  
Mail: Sales.IA.FR@deltaww.com  
TEL: +33(0)1 69 77 82 60

### Iberia: Delta Electronics Solutions (Spain) S.L.U

Ctra. De Villaverde a Vallecas, 265 1º Dcha Ed.  
Hormigueras – P.I. de Vallecas 28031 Madrid  
TEL: +34(0)91 223 74 20

### Carrer Llacuna 166, 08018 Barcelona, Spain

Mail: Sales.IA.Iberia@deltaww.com

### Italy: Delta Electronics (Italy) S.r.l.

Via Meda 2-22060 Novedrate(CO)  
Piazza Grazioli 18 00186 Roma Italy  
Mail: Sales.IA.Italy@deltaww.com  
TEL: +39 039 8900365

### Russia: Delta Energy System LLC

Vereyskaya Plaza II, office 112 Vereyskaya str.  
17 121357 Moscow Russia  
Mail: Sales.IA.RU@deltaww.com  
TEL: +7 495 644 3240

### Turkey: Delta Greentech Elektronik San. Ltd. Sti. (Turkey)

Şerifali Mah. Hendem Cad. Kule Sok. No:16-A  
34775 Ümraniye – İstanbul  
Mail: Sales.IA.Turkey@deltaww.com  
TEL: + 90 216 499 9910

### MEA: Eltek Dubai (Eltek MEA DMCC)

OFFICE 2504, 25th Floor, Saba Tower 1,  
Jumeirah Lakes Towers, Dubai, UAE  
Mail: Sales.IA.MEA@deltaww.com  
TEL: +971(0)4 2690148

## X-ON Electronics

Largest Supplier of Electrical and Electronic Components

*Click to view similar products for [Motor Drives](#) category:*

*Click to view products by [Delta](#) manufacturer:*

Other Similar products are found below :

[GMA02](#) [R7DBP02L](#) [1300920283](#) [GMA20](#) [R88ACRKN020CRE](#) [R88DUA03LAAC100V30W](#) [R88DUP03LAAC100V30W](#)  
[MFECA0050EAM](#) [MFECA0030EAM](#) [1300920078](#) [R88D-GT04H](#) [R88D-KT01H](#) [R7D-BP01H](#) [R88ACR1A005CF](#) [R88D1SN04HECT](#)  
[R88D1SN08HECT](#) [R88ACR1A003CFRA](#) [K6CMISZBI52](#) [KLC35BE](#) [R88A-CA1A010B](#) [ST10-IP-EE](#) [ST10-Q-RN](#) [103H7121-0410P](#)  
[103H7123-0440P](#) [103H7126-0740P](#) [103H7126-5740P](#) [103H7823-5740P](#) [SMCV6150](#) [U-PKZ0\(480V60HZ\)](#) [ODE-3-120070-1F1A-01](#) [ODE-](#)  
[3-240041-3F4B](#) [ODE-3-120070-1F1B-01](#) [132B0107](#) [68581737](#) [3AUA0000072069](#) [3AUA0000089109](#) [ODE-3-220105-1F4B](#)  
[1SFA897103R7000](#) [1SFA897102R7000](#) [3AUA0000058190](#) [68581974](#) [68581796](#) [MCD 201-007-T4-CV1](#) [3AUA0000039627](#)  
[3AXD50000031889](#) [ATS22D17Q](#) [3AXD50000716630](#) [3AUA0000058169](#) [ATV610U55N4](#) [ATV310H075N4E](#)