

# PJT Open Frame Power Supply

## PJT-40 W Series / PJT-□□V40WBA□

# PJT

### Highlights & Features

- Universal AC input voltage
- Standard industrial foot print of 2" x 3"
- Low leakage current < 0.1 mA
- Convection cooled operating temperature range from -10°C to +70°C
- High MTBF > 700,000 hrs as per Telcordia SR-332
- Multiple connector source options

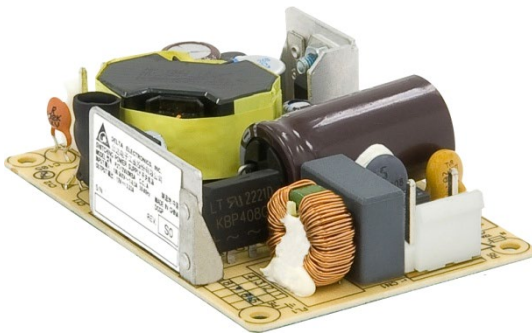

### Safety Standards



CB Certified for worldwide use

**Model Number:** PJT-□□V40WBA□  
**Unit Weight:** 0.08 kg (0.18 lb)  
**Dimensions (L x W x H):** 76.2 x 50.8 x 22.9 mm [2" x 3"]

### General Description

The PJT open frame power supply series offers choices of 12 V, 15 V, 18 V and 24 V nominal output voltages. The single output products are designed with small standard industrial foot prints at 2" x 3". The highly efficient convection cooling designs enable optimum thermal management for high power efficiency. The PJT series of products can operate from -10°C to +70°C across the entire input voltage range of 90 to 264 Vac and are certified for safety standard according to IEC/EN/UL 62368-1 and for EMI standard according to EN/BS EN 55032, Class B.

### Model Information

#### PJT Open Frame Power Supply

Model Number	Input Voltage Range	Rated Output Voltage	Rated Output Current
PJT-12V40WBA□	90-264 Vac	12 Vdc	3.33 A
PJT-15V40WBA□		15 Vdc	2.67 A
PJT-18V40WBA□		18 Vdc	2.22 A
PJT-24V40WBA□		24 Vdc	1.66 A

### Model Numbering

PJ	T –	XX V	40 W	B	A	□
Open Frame	Product Type T – ITE Application Series	Output Voltage 12 V 15 V 18 V 24 V	Output Power	Package Type B – Open Frame	Family Code A	Harness Connector A – JST connector B – Molex connector* C – JWT connector*

\*Options

# PJT Open Frame Power Supply

## PJT-40 W Series / PJT-□□V40WBA□

### Specifications

	Model Number	PJT-12V40WBA□	PJT-15V40WBA□	PJT-18V40WBA□	PJT-24V40WBA□
--	--------------	---------------	---------------	---------------	---------------

#### Input Ratings / Characteristics

Nominal Input Voltage	100-240 Vac				
Input Voltage Range	90-264 Vac				
Nominal Input Frequency	50-60 Hz				
Input Frequency Range	47-63 Hz				
Input Current	< 0.85 A typ. @ 115 Vac				
Efficiency at 100% Load	115 Vac	85.0% typ.	86.0% typ.	86.0% typ.	86.0% typ.
	230 Vac	86.0% typ.	87.0% typ.		87.0% typ.
Max Inrush Current (Cold Start)	30 A typ. @ 115 Vac, 60 A typ. @ 230 Vac				
Leakage Current	0.1 mA @ 240 Vac				

#### Output Ratings / Characteristics

Nominal Output Voltage	12 Vdc	15 Vdc	18 Vdc	24 Vdc
Factory Set Point Tolerance	No potentiometer (± 5%)			
Output Current	3.33 A	2.67 A	2.22 A	1.66 A
Output Power	40 W			
Line Regulation	± 0.5% @ 115 Vac & 230 Vac			
Load Regulation	± 1.0% @ 115 Vac & 230 Vac			
PARD* (20 MHz)	< 120 mVpp	< 150 mVpp	< 180 mVpp	< 240 mVpp
Start-up Time	115 Vac	2800 ms typ. (100% load)		
	230 Vac	1100 ms typ. (100% load)		
Hold-up Time	115 Vac	18 ms typ. (100% load)		
	230 Vac	90 ms typ. (100% load)		
Dynamic Response (Overshoot & Undershoot O/P Voltage)	± 5% @ 50-100% load (Slew Rate: 0.1A/μS)			
Start-up with Capacitive Loads	4,000uF Max	3,500uF Max	3,000uF Max	2,000uF Max

\*PARD is measured with an AC coupling mode, 5 cm wires, and in parallel with 0.1 μF ceramic capacitor & 47 μF electrolytic capacitor.

### Mechanical

Dimensions	76.2 x 50.8 x 22.9 mm [ 2" x 3"]				
Unit Weight	0.08 kg (0.18 lb)				
Cooling System	Convection				
Power Supply Header	PJT-□□V40WBA <u>A</u>	Input: JST B2P3-VH (LF)(SN) Output: JST B4P-VH (LF)(SN)			
	PJT-□□V40WBA <u>B</u>	Input: Molex 26-62-4030 Output: Molex 26-60-4040			
	PJT-□□V40WBA <u>C</u>	Input: JWT A3963WV2-3P-D Output: JWT A3963WV2-4P			
Wire	AWG 22-18				

# PJT Open Frame Power Supply

## PJT-40 W Series / PJT-□□V40WBA□

### Environment

Surrounding Air Temperature	Operating	-10°C to +70°C
	Storage	-40°C to +85°C
Power De-rating	> 50°C de-rate power by 2.5% / °C	
Operating Humidity	10 to 95% RH (Non-Condensing)	
Operating Altitude	0 to 5,000 Meters (16,400 ft.)	
Shock Test (Non-Operating)	IEC 60068-2-27, Half Sine Wave: 50 G for a duration of 11 ms, 3 shocks for each 3 directions	
Vibration (Operating)	IEC 60068-2-6, Sine Wave: 10 Hz to 150 Hz @ 25 m/S <sup>2</sup> (2.5 G); 10 min per cycle, 90 min per axis for all X, Y, Z direction	

### Protections

Overvoltage	13.2-18.0 V, Latch Mode	16.5-22.5 V, Latch Mode	19.8-27.0 V, Latch Mode	26.4-36.0 V, Latch Mode
Overload / Overcurrent	> 140% of rated load current, Hiccup Mode, Non-Latching (Auto-Recovery)			
Over Temperature	Non-Latching (Auto-Recovery)			
Short Circuit	Hiccup Mode, Non-Latching (Auto-Recovery when the fault is removed)			
Protection Against Shock	Class I with PE* connection			

\*PE: Primary Earth

### Reliability Data

MTBF	> 700,000 hrs. as per Telcordia SR-332
Expected Cap Life Time	10 years (115 Vac & 230 Vac, 50% load @ 40°C)

### Safety Standards / Directives

Electrical Safety	TUV Bauart UL/cUL recognized	EN 60950-1/ EN 62368-1 UL 60950-1 and CSA C22.2 No. 60950-1 (File No. E131881) UL 62368-1 and CSA C22.2 No. 62368-1 (File No. E131881)
	CB scheme	IEC 60950-1/ IEC 62368-1
CE	In conformance with EMC Directive 2014/30/EU and Low Voltage Directive 2014/35/EU	
UKCA	In conformance with Electromagnetic Compatibility Regulations 2016 and Electrical Equipment (Safety) Regulations 2016	
Galvanic Isolation	Input to Output	3.0 KVac
	Input to Ground	2.0 KVac
	Output to Ground	0.5 KVac

# PJT Open Frame Power Supply

## PJT-40 W Series / PJT-□□V40WBA□

### EMC

Emissions (CE&RE)	CISPR 32, EN/BS EN 55032, FCC Title 47: Class B		
Immunity to	EN/BS EN 55024		
Electrostatic Discharge	IEC 61000-4-2	Criteria A <sup>1)</sup> Level 3 Air Discharge: 8 kV Level 3 Contact Discharge: 6 kV	
Radiated Field	IEC 61000-4-3	Level 2 Criteria A <sup>1)</sup> 80 MHz-1 GHz, 3 V/M with 1 kHz tone / 80% modulation	
Electrical Fast Transient / Burst	IEC 61000-4-4	Level 3 Criteria A <sup>1)</sup> 2 kV	
Surge	IEC 61000-4-5	Level 3 Criteria A <sup>1)</sup> Common Mode <sup>2)</sup> : 2 kV Differential Mode <sup>3)</sup> : 1 kV	
Conducted	IEC 61000-4-6	Level 2 Criteria A <sup>1)</sup> 3 V with 80% AM	
Power Frequency Magnetic Fields	IEC 61000-4-8	Criteria A <sup>1)</sup> Magnetic field strength 3 A/Meter	
Voltage Dips	IEC 61000-4-11	30% dip; 10 ms Criterion A 60% dip; 100 ms Criterion B 95% dip; 5000 ms Criterion B	
Voltage Fluctuation and Flicker	IEC/EN/BS EN 61000-3-3		

- 1) Criteria A: Normal performance within the specification limits
- 2) Asymmetrical: Common mode (Line to earth)
- 3) Symmetrical: Differential mode (Line to line)

### Block Diagram

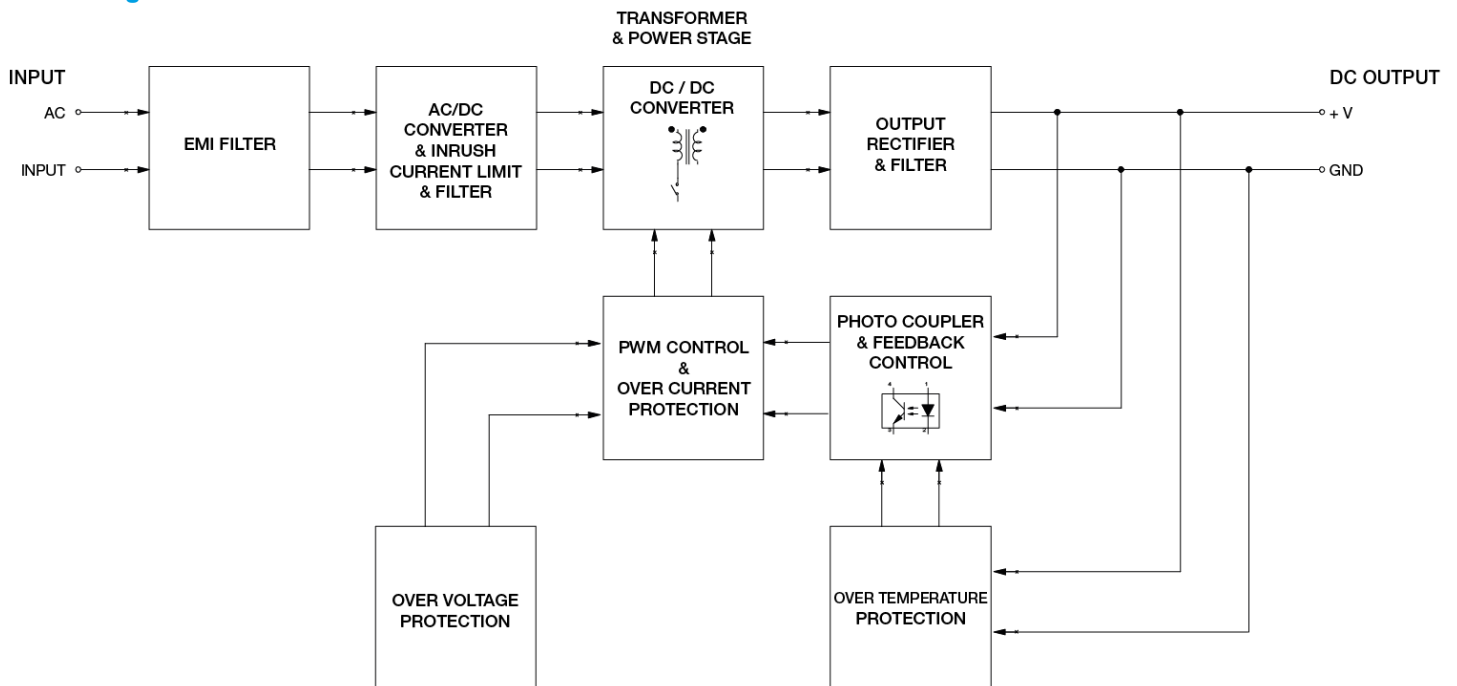

# PJT Open Frame Power Supply

## PJT-40 W Series / PJT-□□V40WBA□

### Dimensions

L x W x H: 76.2 x 50.8 x 22.9 mm [2" x 3"]

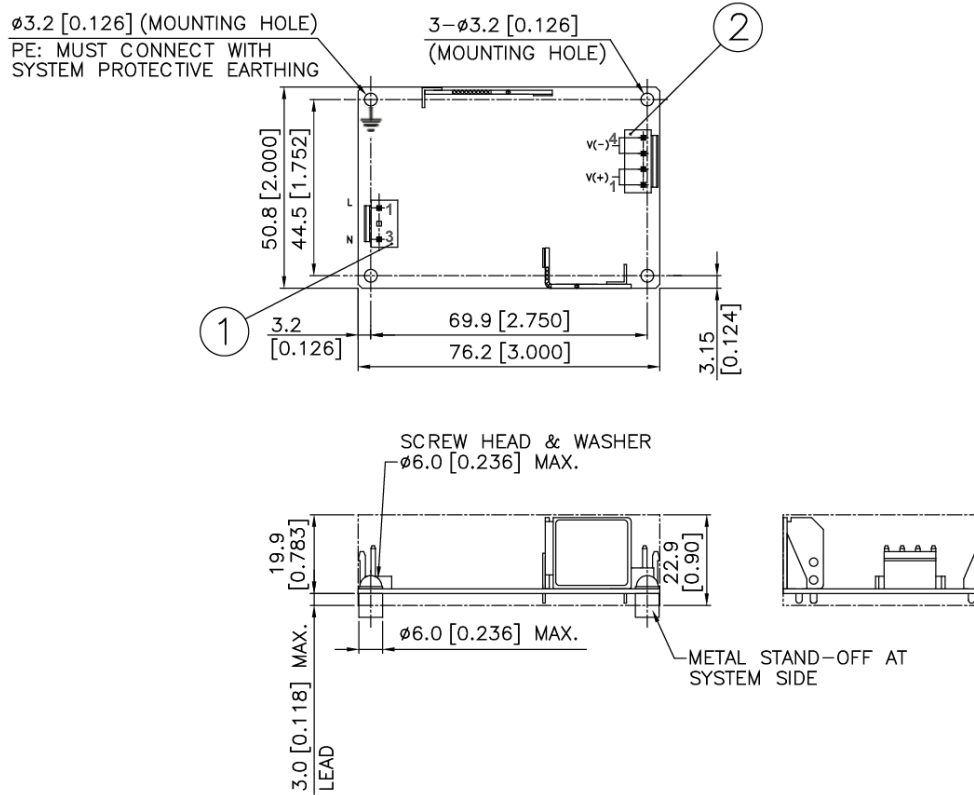

Item	Device Description
1	Input Connector (CN1) Pin 1: Line Pin 2: NC Pin 3: Neutral
2	Output Connector (CN2) Pin 1 to 2 : V(+) Pin 3 to 4 : V(-)

# PJT Open Frame Power Supply

## PJT-40 W Series / PJT-□□V40WBA□

### Engineering Data

#### Output Load De-rating VS Surrounding Air Temperature

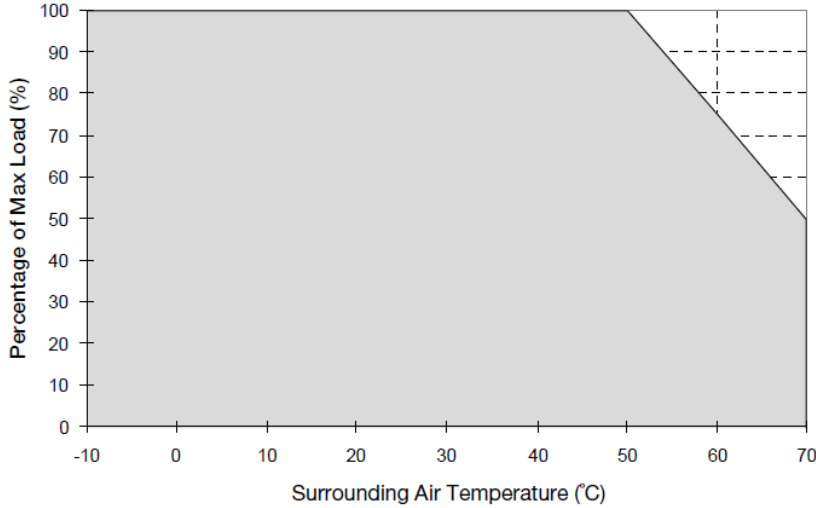
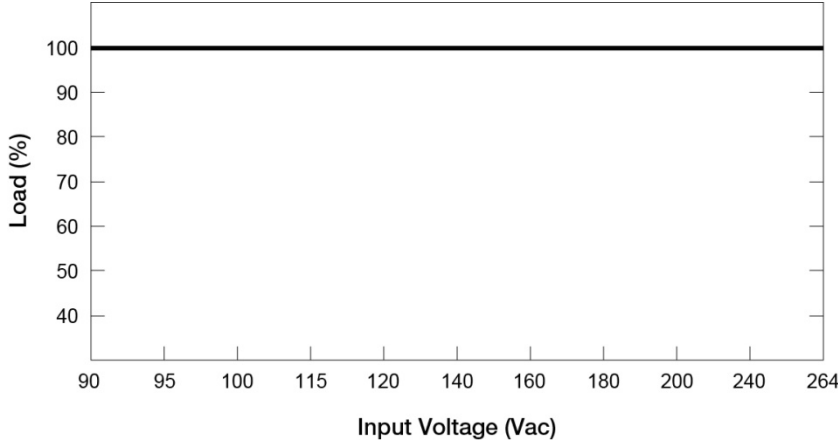

**Fig. 1 De-rating for Horizontal Mounting Orientation**  
 > 50°C de-rate power by 2.5% / °C

#### Note

1. Power supply components may degrade, or be damaged, when the power supply is continuously used outside the shaded region, refer to the graph shown in Fig. 1.
2. If the output capacity is not reduced when the surrounding air temperature >50°C, the device will run into Over Temperature Protection. When activated, the output voltage will go into bouncing mode and will recover when the surrounding air temperature is lowered or the load is reduced as far as necessary to keep the device in working condition.
3. Depending on the surrounding air temperature and output load delivered by the power supply, the device can be very hot!
4. If the device has to be mounted in any other orientation, please contact [info@deltapsu.com](mailto:info@deltapsu.com) for more details.

#### Output Load De-rating VS Input Voltage



- No output power de-rating for the input voltage from 90 Vac to 264 Vac

■ L Frame / Enclosed



# PJT Open Frame Power Supply

## PJT-40 W Series / PJT-□□V40WBA□

### Functions

#### Start-up Time

The time required for the output voltage to reach 90% of its final steady state set value, after the input voltage is applied.

#### Rise Time

The time required for the output voltage to change from 10% to 90% of its final steady state set value.

#### Hold-up Time

Time between the collapse of the AC input voltage, and the output falling to 95% of its steady state set value.

### ■ Graph illustrating the Start-up Time, Rise Time, and Hold-up Time

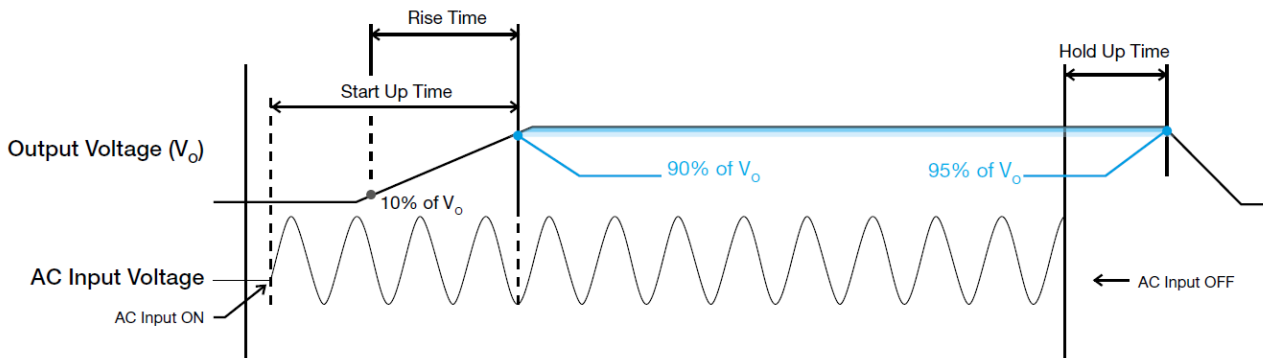

### Inrush Current

Inrush current is the peak, instantaneous, input current measured and, occurs when the input voltage is first applied. For AC input voltages, the maximum peak value of inrush current will occur during the first half cycle of the applied AC voltage. This peak value decreases exponentially during subsequent cycles of AC voltage.

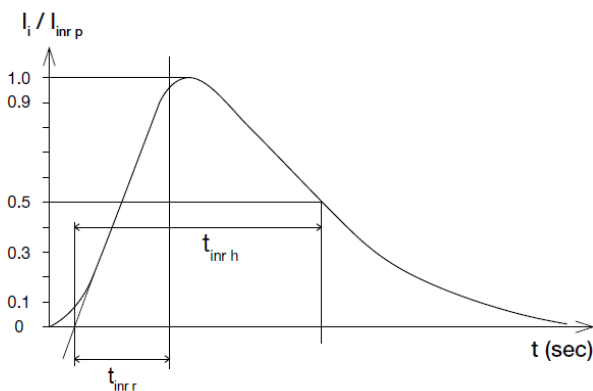

### Dynamic Response

The power supply output voltage will remain within  $\pm 5\%$  of its steady state value, when subjected to a dynamic load from 0 to 100% of its rated current.

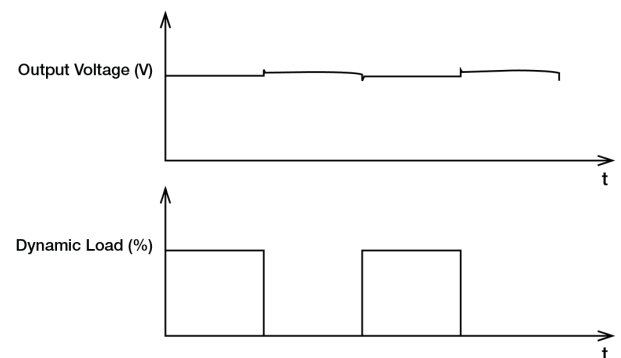



# PJT Open Frame Power Supply

## PJT-40 W Series / PJT-□□V40WBA□

### Overload & Overcurrent Protections (Auto-Recovery)

The power supply's Overload (OLP) and Overcurrent (OCP) Protections will be activated when output current exceeds 140% of  $I_O$  (Max load). In such occurrence, the  $V_O$  will start to droop and once the power supply has reached its maximum power limit, the protection is activated and the power supply will go into "Hiccup mode" (Auto-Recovery). The power supply will recover once the fault condition of the OLP and OCP is removed and  $I_O$  is back within the specifications.

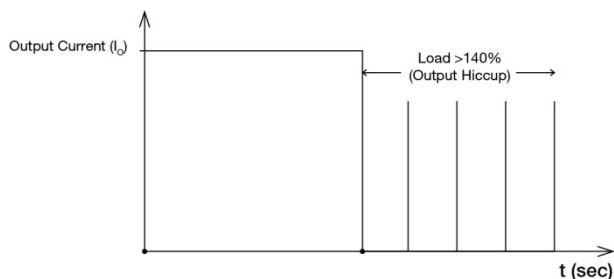

It is not recommended to prolong the duration of  $I_O$  when it is <140% but >100%, since it may cause damage to the PSU.

### Short Circuit Protection (Auto-Recovery)

The power supply's output OLP/OCP function also provides protection against short circuits. When a short circuit is applied, the output current will operate in "Hiccup mode", as shown in the illustration in the OLP/OCP section on this page. The power supply will return to normal operation after the short circuit is removed.

### Others

#### Attention

Delta provides all information in the datasheets on an "AS IS" basis and does not offer any kind of warranty through the information for using the product. In the event of any discrepancy between the information in the catalog and datasheets, the datasheets shall prevail (please refer to [www.DeltaPSU.com](http://www.DeltaPSU.com) for the latest datasheets information). Delta shall have no liability of indemnification for any claim or action arising from any error for the provided information in the datasheets. Customer shall take its responsibility for evaluation of using the product before placing an order with Delta.

Delta reserves the right to make changes to the information described in the datasheets without notice.

### Manufacturer and Authorized Representatives Information

#### Manufacturer

Thailand  
Delta Electronics (Thailand) PCL.  
909 Pattana 1 Rd., Muang, Samutprakarn, 10280 Thailand

Taiwan  
Delta Electronics, Inc.  
3 Tungyuan Road, Chungli Industrial Zone, Taoyuan County  
32063, Taiwan

#### Authorized Representatives

The Netherlands  
Delta Greentech (Netherlands) B.V.  
Zandsteen 15, 2132 MZ Hoofddorp, The Netherlands

United Kingdom  
Delta Electronics Europe Limited  
1 Redwood Court, Peel Park Campus,  
East Kilbride, Glasgow, G74 5PF, United Kingdom

### Overvoltage Protection (Latch Mode)

The power supply's overvoltage circuit will be activated when its internal feedback circuit fails. The output voltage shall not exceed its specifications defined on Page 3 under "Protections". Power supply will latch off, and require removal/re-application of input AC voltage in order to restart.

**The power supply should be latch.**

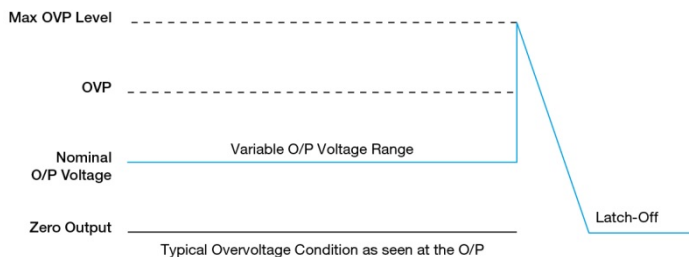

### Over Temperature Protection (Auto-Recovery)

As described in load de-rating section, the power supply also has Over Temperature Protection (OTP). In the event of a higher operating temperature at 100% load, the power supply will run into OTP when the operating temperature is beyond what is recommended in the de-rating graph. When activated, the output voltage will go into bouncing mode until the temperature drops to its normal operating temperature as recommended in the de-rating graph.

## X-ON Electronics

Largest Supplier of Electrical and Electronic Components

*Click to view similar products for [Switching Power Supplies](#) category:*

*Click to view products by [Delta](#) manufacturer:*

Other Similar products are found below :

[70841011](#) [73-551-0005](#) [73-551-0048](#) [PS3E-B12F](#) [PS3E-E12F](#) [AAD600S-4-OP](#) [R22095](#) [KD0204](#) [9021](#) [LDIN100150](#) [LPM000-BBAR-01](#)  
[LPX17S-C](#) [EVS57-10R6/R](#) [FP80](#) [FRV7000G](#) [22929](#) [PS3E-F12F](#) [CQM1IA121](#) [40370121900](#) [VI-PU22-EXX](#) [40370121910](#) [LDIN5075](#)  
[LPM615-CHAS](#) [LPX140-C](#) [09-160CFG](#) [70841025](#) [VPX3000-CBL-DC](#) [VI-LUL-IU](#) [LPM000-BBAR-05](#) [LPM000-BBAR-08](#) [LPM124-](#)  
[OUTA1-48](#) [LPM000-BBAR-07](#) [LPM109-OUTA1-10](#) [LPM616-CHAS](#) [08-30466-1055G](#) [08-30466-2175G](#) [08-30466-2125G](#) [DMB-EWG](#)  
[TVQF-1219-18S](#) [6504-226-2101](#) [CQM1IPS01](#) [SP-300-5](#) [CQM1-IPS02](#) [VI-MUL-ES](#) [22829](#) [08-30466-0065G](#) [VI-RU031-EWWX](#) [08-30466-](#)  
[0028G](#) [EP3000AC48INZ](#) [VP-C2104853](#)