

PMT Panel Mount Power Supply

5 V 35 W 1 Phase / PMT-5V35W1A□

PMT

Highlights & Features

- Universal AC input range
- Power will not de-rate from input voltage 100 Vac to 264 Vac
- High MTBF > 700,000 hrs. per Telcordia SR-332
- Short Circuit / Overvoltage / Overload / Over Temperature Protections
- Versatile connector options (Terminal Block, Front Face, Harness)



Safety Standards



CB Certified for worldwide use

Model Number:	PMT-5V35W1A□
Unit Weight:	0.23 kg (0.51 lb)
Dimensions (L x W x H):	98 x 98 x 38 mm (3.86 x 3.86 x 1.50 inch)

General Description

The new PMT series of panel mount power supplies is the latest offering from one of the world's largest power supply manufacturers and solution providers – Delta. The PMT products also offer a nominal output voltage of 5 V with a wide operating temperature range from -10°C to +70°C and can withstand shock and vibration requirements (in accordance to IEC 60068-2-27 and IEC 60068-2-6 respectively). In addition to features like overvoltage and overload protections, Delta's PMT series of panel mount power supplies is unlike many other brands in the same price level. The PMT series is designed for cost competitive markets without compromising the quality of the components and product specifications. The series of products has an expected life time of 10 years and this versatile product has three different connector options (Terminal Block, Front Face and Harness) and can also be converted into L Frame (PML) type of power supplies to satisfy different application needs.

Model Information

PMT Panel Mount Power Supply

Model Number	Input Voltage Range	Rated Output Voltage	Rated Output Current
PMT-5V35W1A□	85-264 Vac	5 Vdc	7.00 A

Model Numbering

PM	□ -	5V	35W	1	A	□
Panel Mount	Product Type T – Enclosed L – L Frame*	Output Voltage	Output Power	Single Phase	No PFC	Connector Type A – Terminal Block G – Front Face* H – Harness*

*Options



A



G



H

PMT Panel Mount Power Supply

5 V 35 W 1 Phase / PMT-5V35W1A□

Specifications

Input Ratings / Characteristics

Nominal Input Voltage	100-240 Vac
Input Voltage Range	85-264 Vac
Nominal Input Frequency	50-60 Hz
Input Frequency Range	47-63 Hz
Input Current	< 0.75 A @ 115 Vac, < 0.50 A @ 230 Vac
Efficiency at 100% Load	81.0% typ. @ 230 Vac
Max Inrush Current (Cold Start)	45 A typ. @ 230 Vac
Leakage Current	< 0.5 mA @ 240 Vac

Output Ratings / Characteristics

Nominal Output Voltage	5 Vdc
Output Voltage Tolerance	± 1% (initial set point tolerance from factory)
Output Voltage Adjustment Range	4.50-5.50 Vdc
Output Current	7.00 A
Output Power	35 W
Line Regulation	< 0.5% typ. (@ 115 Vac & 230 Vac input, 100% input)
Load Regulation	< 1% typ. (@ 115 Vac & 230 Vac input, 0-100% input)
PARD (20MHz)	< 80 mVpp @ 25°C to 50°C, < 160 mVpp @ -10°C to 0°C
Rise Time	< 30 ms @ nominal input (100% load)
Start-up Time	1,200 ms typ. @ 115 Vac, 500 ms typ. @ 230 Vac (100% load)
Hold-up Time	20 ms typ. @ 115 Vac, 100 ms typ. @ 230 Vac
Dynamic Response (Overshoot & Undershoot O/P Voltage)	± 10% (1000 mV _{p-p}) @ 0-100% load (Slew Rate: 0.1 A/μS)
Start-up with Capacitive Loads	8,000 μF Max

PMT Panel Mount Power Supply

5 V 35 W 1 Phase / PMT-5V35W1A□

Mechanical

Case Chassis	Aluminium	
Case Cover	SGCC	
Dimensions (L x W x H)	98 x 98 x 38 mm (3.86 x 3.86 x 1.50 inch)	
Unit Weight	0.23 kg (0.51 lb)	
Indicator	Green LED (DC OK)	
Cooling System	Convection	
Terminal	PM□-5V35W1AA	M3.5 x 5 Pins (Rated 300 V /15 A)
	PM□-5V35W1AG	M3.5 x 5 Pins (Rated 300 V /20 A)
	PM□-5V35W1AH	I/P (JST): B3P5-VH(LF)(SN) O/P (JST): B2P3-VH(LF)(SN)
Wire	PM□-5V35W1AA	AWG 18-12
	PM□-5V35W1AG	AWG 18-12
	PM□-5V35W1AH	AWG 18 (For the recommended Housing and Terminal, please refer to the Table on Page 10)
Noise (1 Meter from power supply)	Sound Pressure Level (SPL) < 25 dBA	

Environment

Surrounding Air Temperature	Operating	-10°C to +70°C
	Storage	-25°C to +85°C
Power De-rating	> 50°C de-rate power by 2.5% / °C < 100Vac de-rate power by 1.33% / V (80% load @ 85 Vac)	
Operating Humidity	5 to 95% RH (Non-Condensing)	
Operating Altitude	0 to 5,000 Meters (0 to 16,400 ft)	
Shock Test (Non-Operating)	IEC 60068-2-27, Half Sine Wave: 50 G for a duration of 11 ms, 3 shocks for each 3 directions	
Vibration (Non-Operating)	IEC 60068-2-6, Random: 5 Hz to 500 Hz (2.09 Grms); 20 min per axis for all X, Y, Z direction	
Pollution Degree	2	

Protections

Overvoltage	5.75-7.50 V, SELV Output, Hiccup Mode, Non-Latching (Auto-Recovery)
Overload / Overcurrent	105-150% of rated load current, Hiccup Mode, Non-Latching (Auto-Recovery)
Over Temperature	Non-Latching (Auto-Recovery)
Short Circuit	Hiccup Mode, Non-Latching (Auto-Recovery when the fault is removed)
Protection Against Shock	Class I with PE* connection

*PE: Primary Earth

PMT Panel Mount Power Supply

5 V 35 W 1 Phase / PMT-5V35W1A □

Reliability Data

MTBF	> 700,000 hrs. as per Telcordia SR-332 I/P: 100 Vac, O/P: 100% Load, Ta: 35°C)
Expected Cap Life Time	10 years (115 Vac & 230 Vac, 50% load @ 40°C)

Safety Standards / Directives

Electrical Safety	TUV Bauart UL/cUL recognized CB scheme BIS CCC	EN 60950-1, EN 62368-1 UL 60950-1 and CSA C22.2 No. 60950-1 (File No. E131881) UL 62368-1 and CSA C22.2 No. 62368-1 (File No. E131881) IEC 60950-1, IEC 62368-1 IS 13152-1 GB 4943
CE		In conformance with EMC Directive 2014/30/EU and Low Voltage Directive 2014/35/EU
UKCA		In conformance with Electromagnetic Compatibility Regulations 2016 and Electrical Equipment (Safety) Regulations 2016
Galvanic Isolation	Input to Output	3.0 KVac
	Input to Ground	1.5 KVac
	Output to Ground	0.5 KVac

EMC

EMC / Emissions		CISPR 22, EN/BS EN 55032, FCC Title 47: Class B
Immunity to		EN/BS EN 55024
Electrostatic Discharge	IEC 61000-4-2	Level 4 Criteria A ¹⁾ Air Discharge: 15 kV Contact Discharge: 8 kV
Radiated Field	IEC 61000-4-3	Level 3 Criteria A ¹⁾ 80 MHz-1 GHz, 10 V/M with 1 kHz tone / 80% modulation
Electrical Fast Transient / Burst	IEC 61000-4-4	Level 3 Criteria A ¹⁾ 2 kV
Surge	IEC 61000-4-5	Level 3 Criteria A ¹⁾ Common Mode ²⁾ : 2 kV Differential Mode ³⁾ : 1 kV
Conducted	IEC 61000-4-6	Level 3 Criteria A ¹⁾ 150 kHz-80 MHz, 10 Vrms
Power Frequency Magnetic Fields	IEC 61000-4-8	Criteria A ¹⁾ 10 A / Meter
Voltage Dips	IEC 61000-4-11	100% dip; 1 cycle (20 ms); Self Recoverable
Low Energy Pulse Test (Ring Wave)	IEC 61000-4-12	Level 3 200 A Criteria A ¹⁾ Common Mode ²⁾ : 2 kV Differential Mode ³⁾ : 1 kV

1) Criteria A: Normal performance within the specification limits

2) Asymmetrical: Common mode (Line to earth)

3) Symmetrical: Differential mode (Line to line)

PMT Panel Mount Power Supply

5 V 35 W 1 Phase / PMT-5V35W1A□

Block Diagram

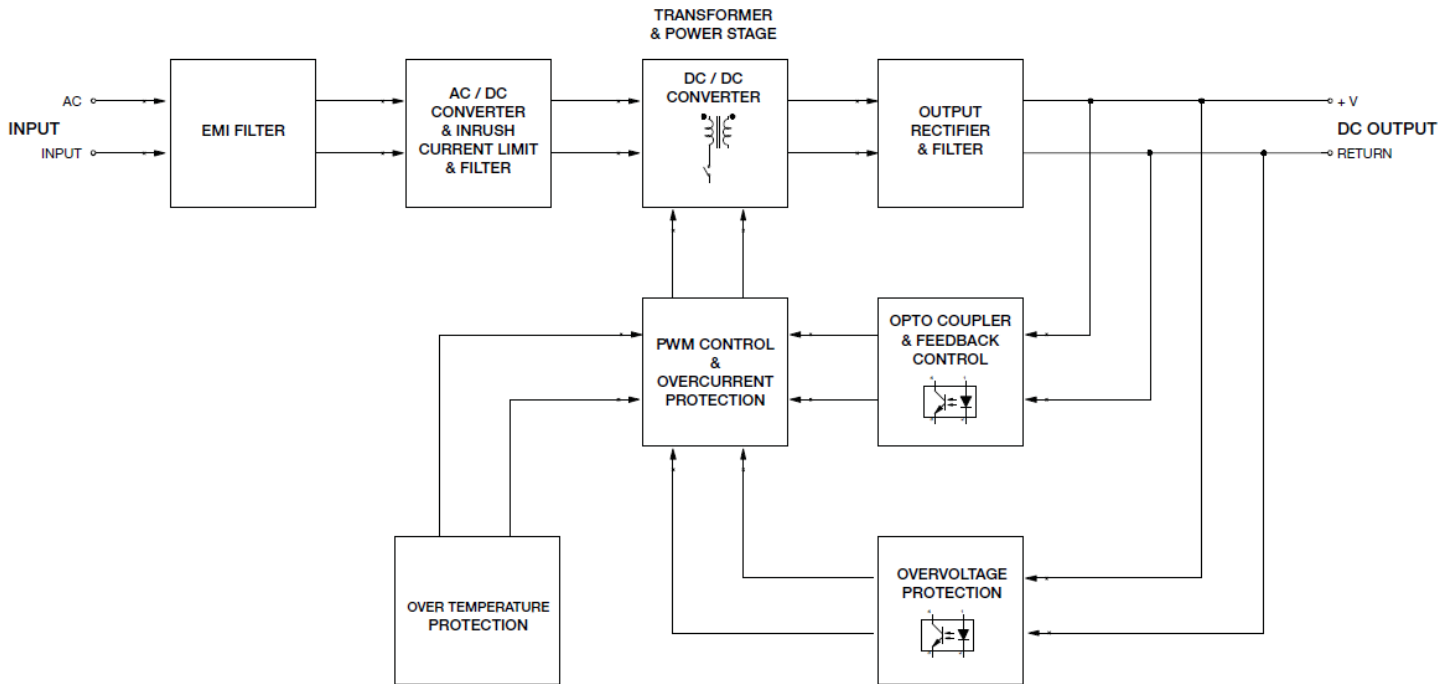

Device Descriptions

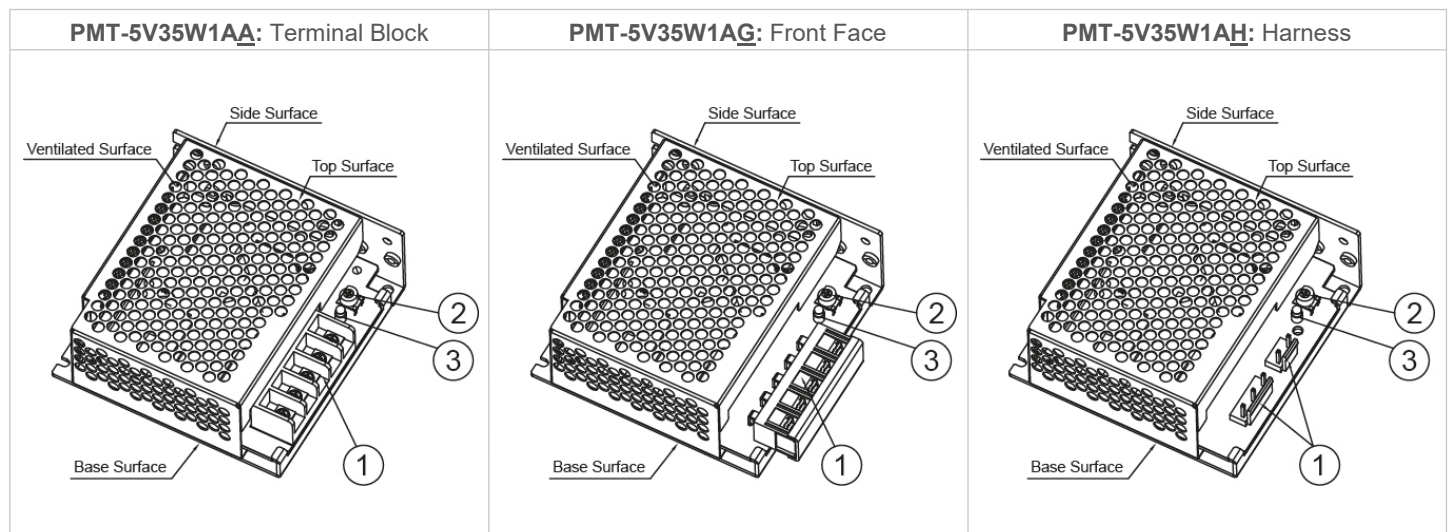

- 1) Input & Output terminal block connector
- 2) DC voltage adjustment potentiometer
- 3) DC OK control LED (Green)

PMT Panel Mount Power Supply

5 V 35 W 1 Phase / PMT-5V35W1A□

Dimensions

PMT-5V35W1AA: Terminal Block

L x W x H: 98 x 98 x 38 mm (3.86 x 3.86 x 1.50 inch)

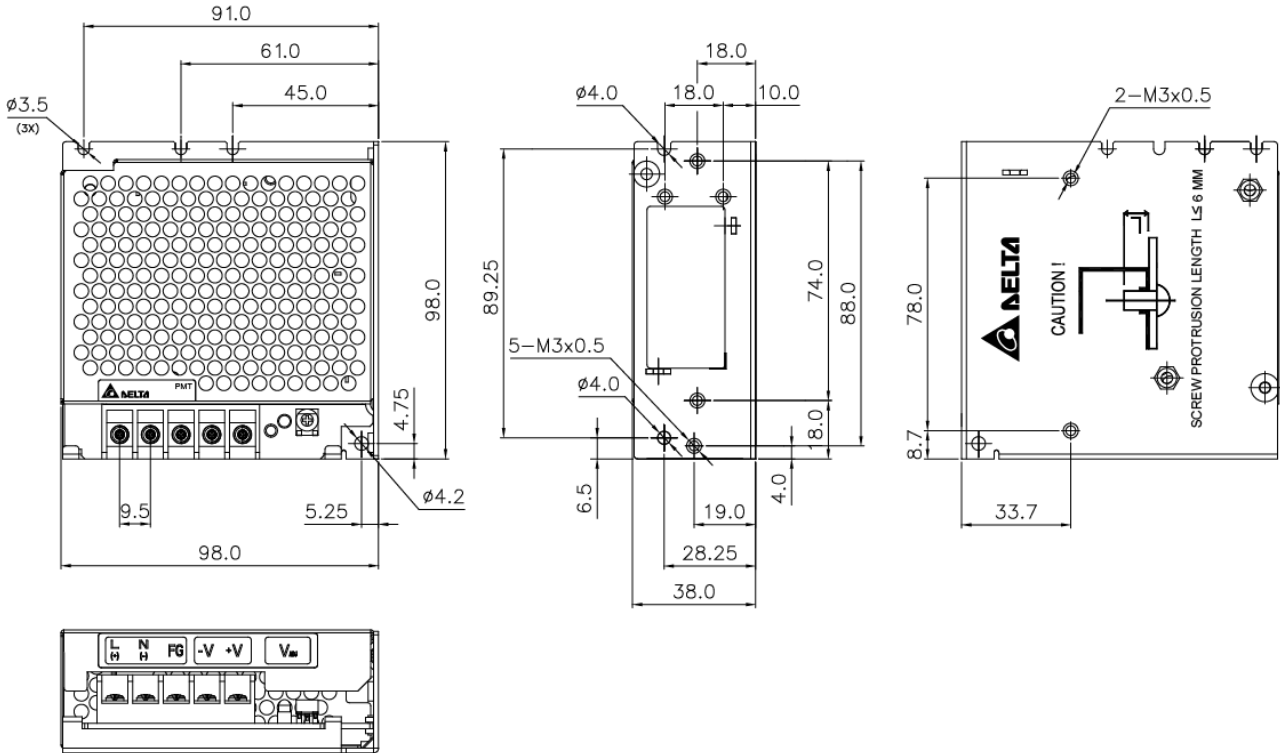

PMT-5V35W1AG: Front Face

L x W x H: 98 x 98 x 38 mm (3.86 x 3.86 x 1.50 inch)

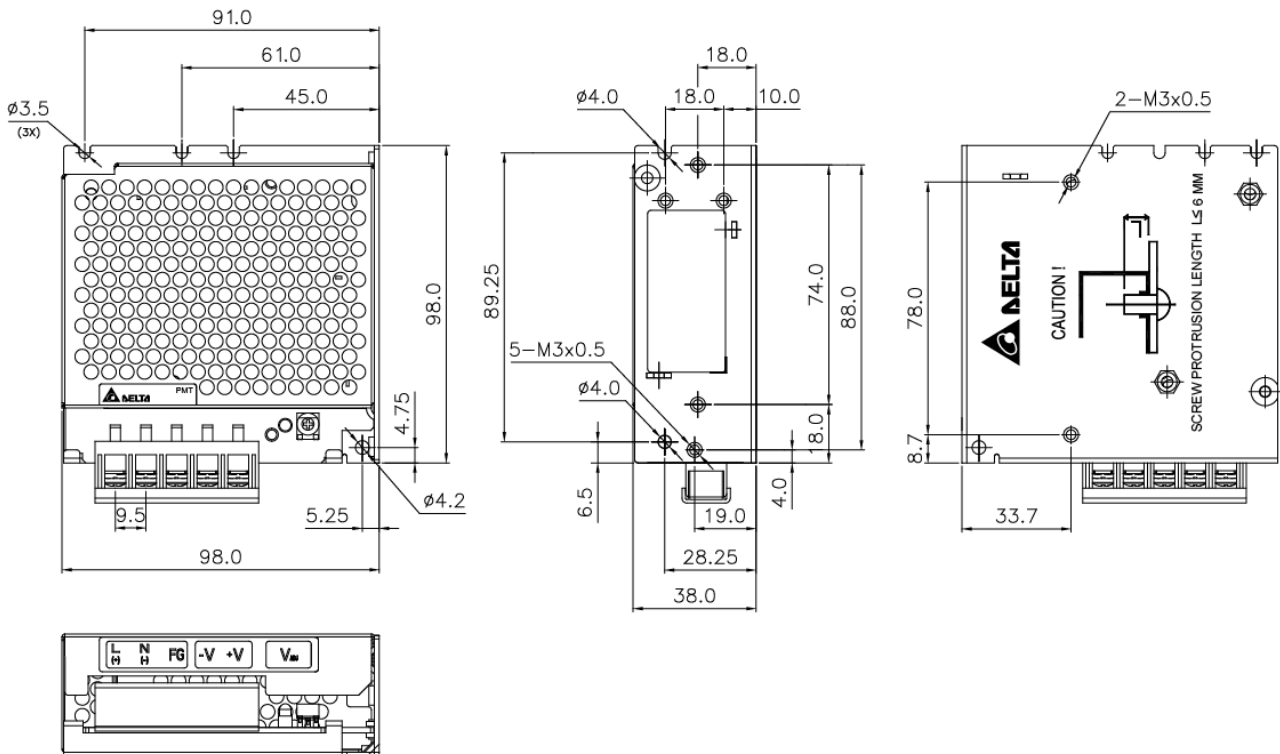

PMT Panel Mount Power Supply

5 V 35 W 1 Phase / PMT-5V35W1A□

PMT-5V35W1A□: Harness

L x W x H: 98 x 98 x 38 mm (3.86 x 3.86 x 1.50 inch)

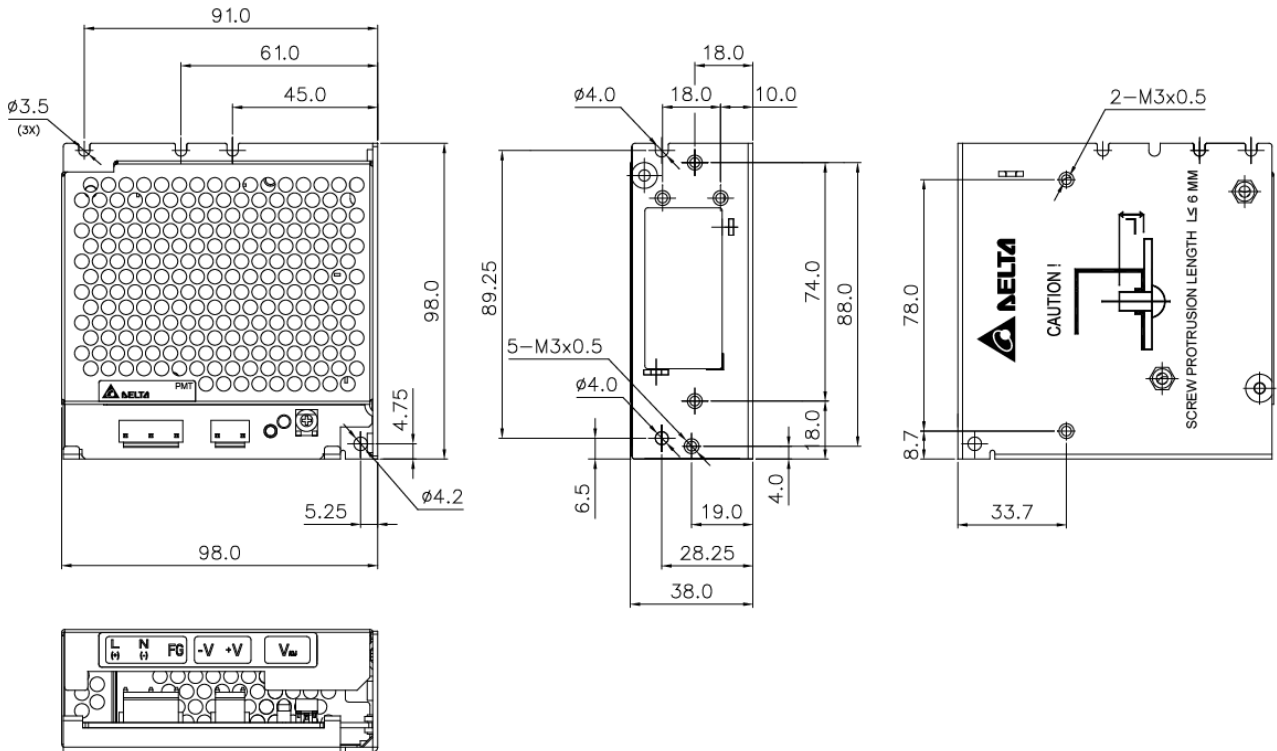

PML-5V35W1AA: Terminal Block

L x W x H: 98 x 98 x 37.5 mm (3.86 x 3.86 x 1.48 inch)

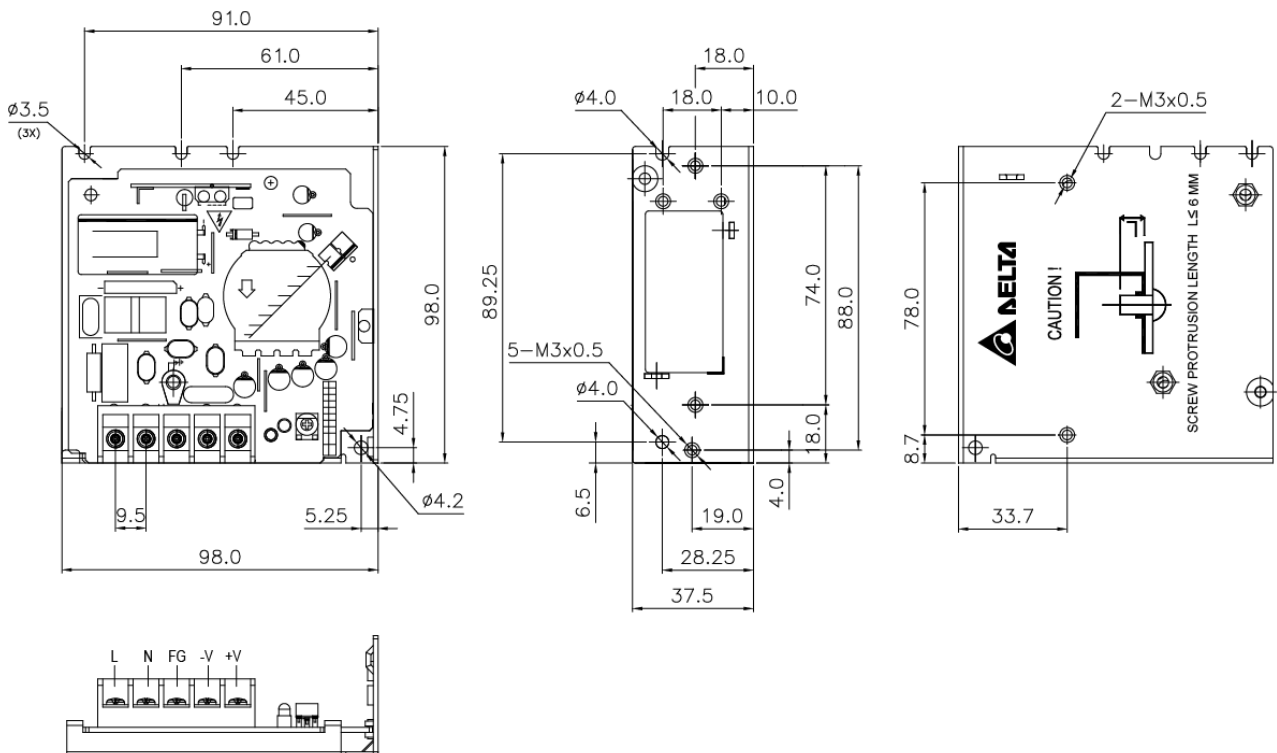

PMT Panel Mount Power Supply

5 V 35 W 1 Phase / PMT-5V35W1A□

PML-5V35W1AG: Front Face

L x W x H: 98 x 98 x 37.5 mm (3.86 x 3.86 x 1.48 inch)

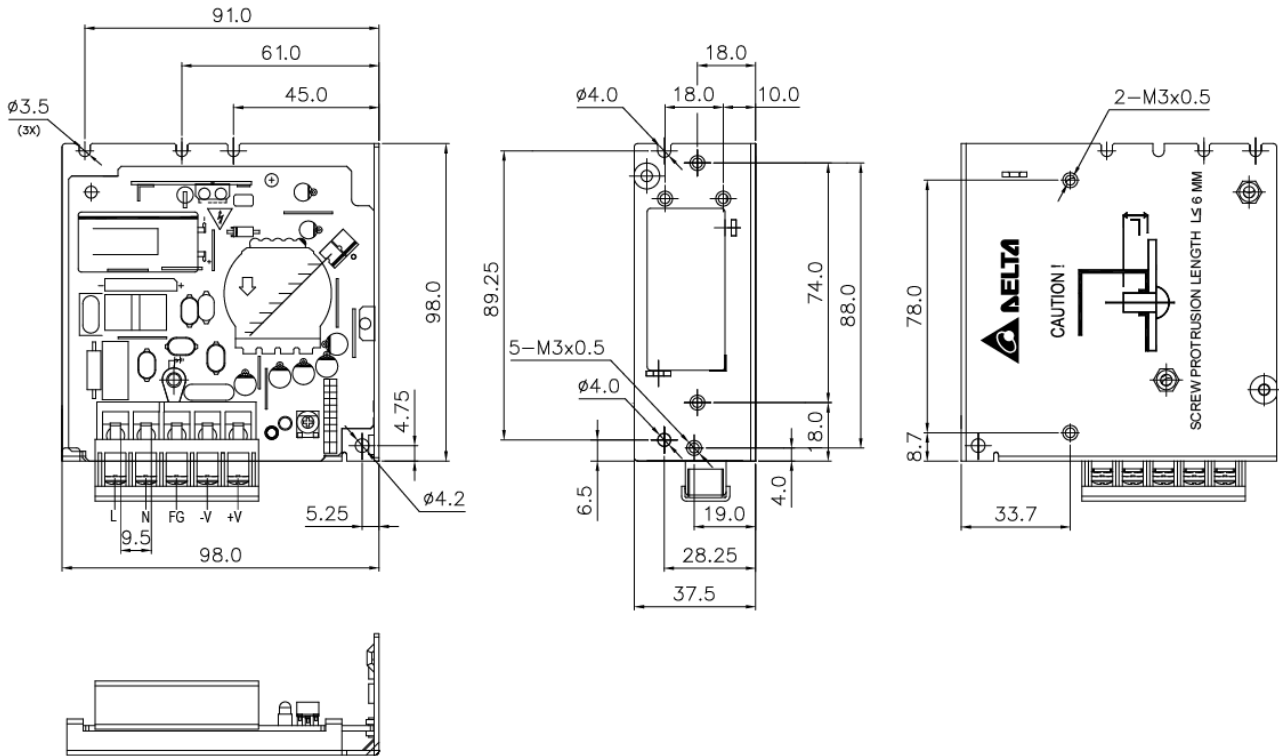

PML-5V35W1AH: Harness

L x W x H: 98 x 98 x 37.5 mm (3.86 x 3.86 x 1.48 inch)

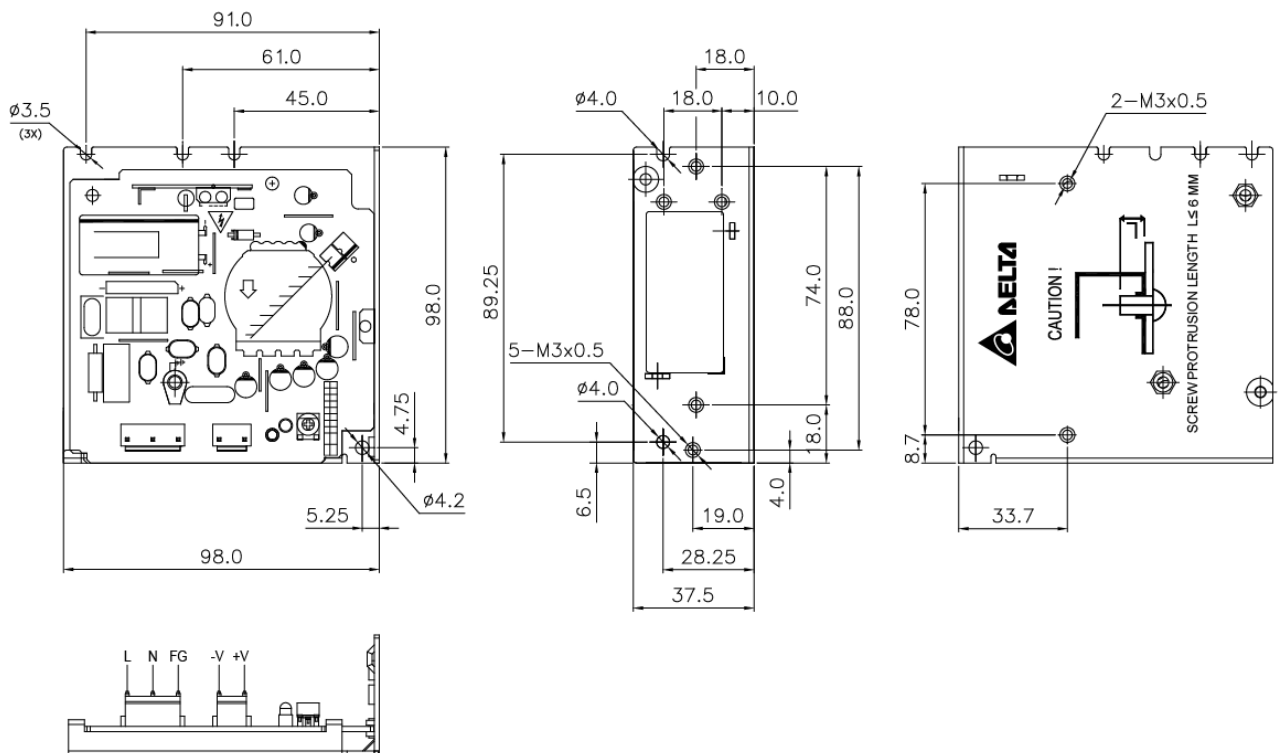

PMT Panel Mount Power Supply

5 V 35 W 1 Phase / PMT-5V35W1A□

Engineering Data

De-rating

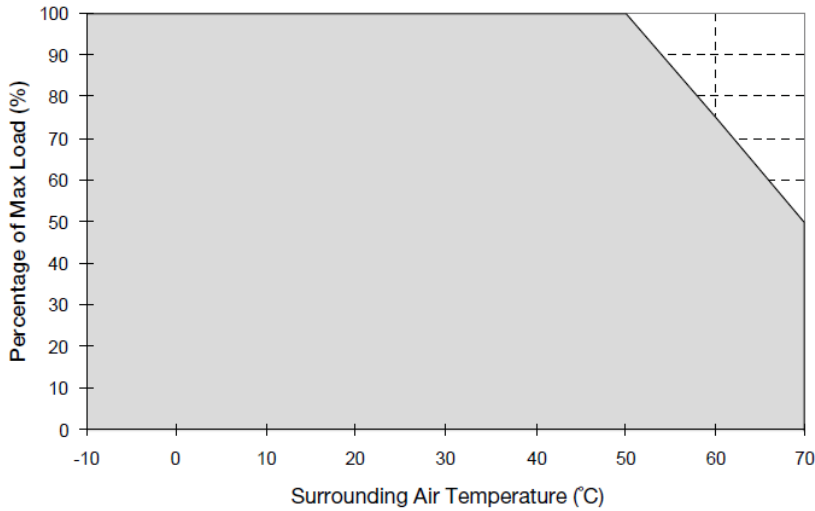
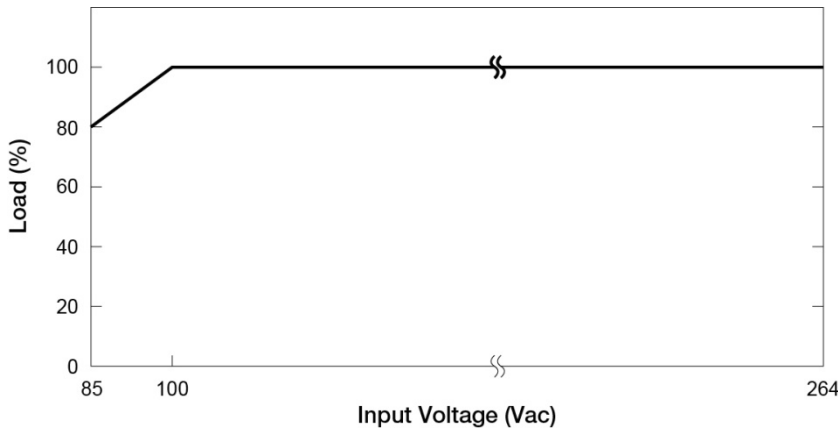

Fig. 1 De-rating for Vertical and Horizontal Mounting Orientation
 > 50°C de-rate power by 2.5% / °C

Note

1. Power supply components may degrade, or be damaged, when the power supply is continuously used outside the shaded region, refer to the graph shown in Fig. 1.
2. If the output capacity is not reduced when the surrounding air temperature >50°C, the device will run into Over Temperature Protection. When activated, the output voltage will go into bouncing mode and will recover when the surrounding air temperature is lowered or the load is reduced as far as necessary to keep the device in working condition.
3. In order for the device to function in the manner intended, it is also necessary to keep a safety distance of 20mm with adjacent units while the device is in operation.
4. Depending on the surrounding air temperature and output load delivered by the power supply, the device can be very hot!
5. If the device has to be mounted in any other orientation, please do not hesitate to contact info@deltapsu.com for more details.

Output De-rating VS. Input Voltage



- No output power de-rating for the input voltage from 100 Vac to 264 Vac

PMT Panel Mount Power Supply

5 V 35 W 1 Phase / PMT-5V35W1A□

Assembly & Installation

- (A) Mounting holes for power supply (device). The power supply shall be mounted on minimum 2 mounting holes using M3 screw minimum 5 mm length.
- (B) This surface belongs to customer's end system or panel where the power supply is mounted.
- (C) Connector

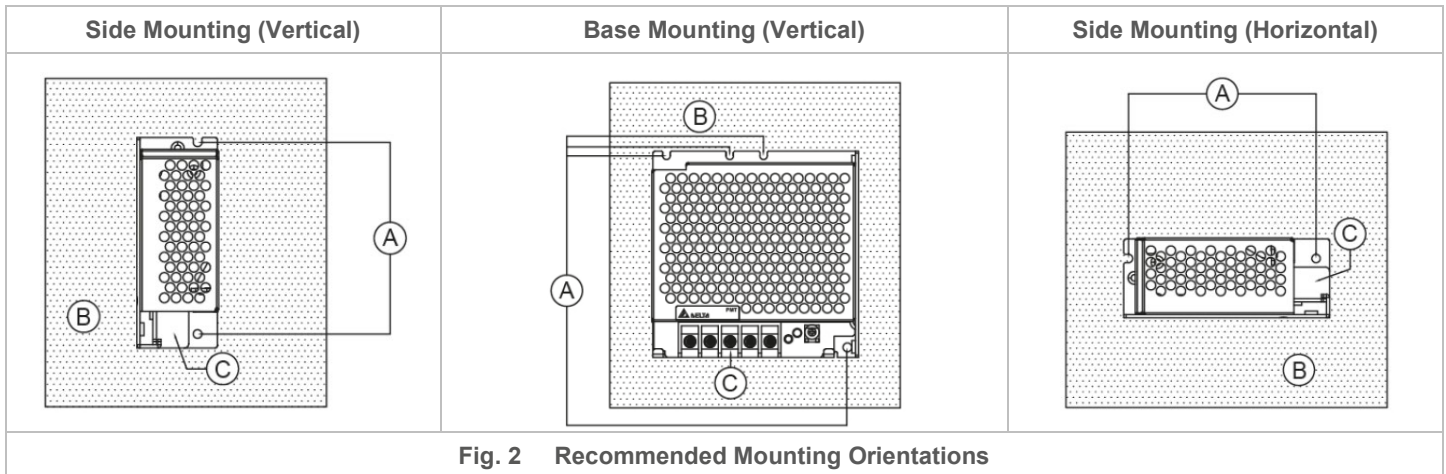

Fig. 2 Recommended Mounting Orientations

- **PM□-5V35W1AA / PM□-5V35W1AG:** Use flexible cable (stranded or solid) of AWG No. 18-12. User should calculate and select the suitable wire specification (type/quantity/diameter) according to actual output current. The torque at the Connector shall not exceed 13Kgf.cm. The insulation stripping length should not exceed 0.275" or 7 mm (Refer to Fig. 3).
- **PM□-5V35W1AH:** Use flexible cable (stranded or solid) of AWG No. 18. Please refer to Table 1 for the recommended Housing and Terminal.

Table 1	Connector (Board Mounting)	Housing	Terminal
Input (JST)	B3P5-VH(LF)(SN)	VHR-5N	SVH-21T-P1.1
Output (JST)	B2P3-VH(LF)(SN)	VHR-3N	

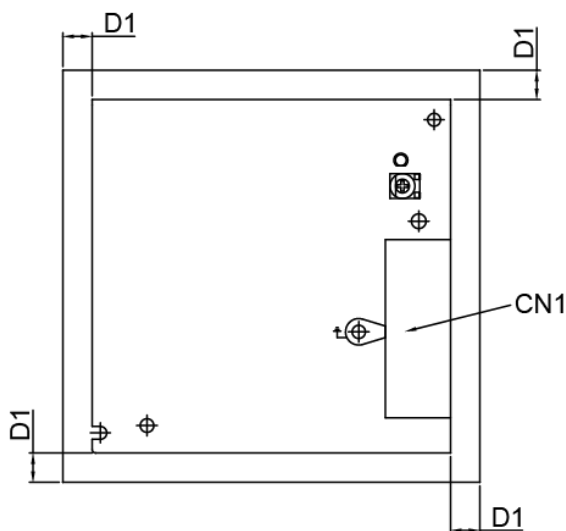
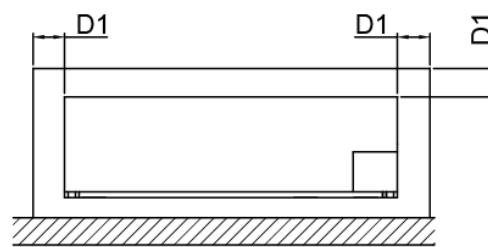

Fig. 3 Assembly Reference



Safety Distance

D1 = 4.0mm Min.

Ensure the mounted device is kept at ≥ 4 mm safety distance at all sides from other components and equipments. In addition, to ensure sufficient convection cooling, always maintain a distance of ≥ 20 mm from ventilated surfaces while the device is in operation.

PMT Panel Mount Power Supply

5 V 35 W 1 Phase / PMT-5V35W1A□

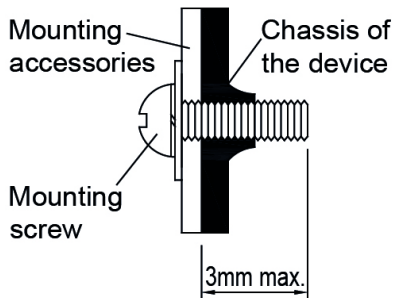

- **For PMT and PML Series (Refer to Fig. 4):** Only use M3 screw ≤ 3 mm through the base mounting holes. This is to keep a safe distance between the screw and internal components. Recommended mounting tightening torque: 4~7 Kgf.cm.

Fig. 4 Mounting Screw

Safety Instructions

- If user's mounting orientation is not according to the recommended mounting orientations, please consult Delta for further information.
- L frame (PML) and Open frame (PMB) options are to be manufactured by Delta and not to be reconfigured by users from the standard enclosed configuration.
- The device is not recommended to be placed on low thermal conductive surface. For example, plastics.
- The enclosure of the device can become very hot depending on the ambient temperature and load of the power supply. Do not touch the device while it is in operation or immediately after power is turned OFF. Risk of burning!
- Do not touch the terminals while power is being supplied. Risk of electric shock.
- Prevent any foreign metal, particles or conductors from entering the device through the openings during installation. It may cause electric shock, safety hazard, fire and/or product failure.
- The power supply must be mounted by metal screws onto a grounded metal surface. It is highly recommended that the Earth terminal on the connector be connected to the grounded surface.
- Warning (For Standard Terminal Block and Front Face Terminal Block products): When connecting the device, secure Earth connection before connecting L and N. When disconnecting the device, remove L and N connections before removing the Earth connection.

PMT Panel Mount Power Supply

5 V 35 W 1 Phase / PMT-5V35W1A□

Functions

Start-up Time

The time required for the output voltage to reach 90% of its set value, after the input voltage is applied.

Rise Time

The time required for the output voltage to change from 10% to 90% of its set value.

Hold-up Time

Hold up time is the time when the AC input collapses and output voltage retains regulation for a certain period of time. The time required for the output to reach 95% of its set value, after the input voltage is removed.

■ Graph illustrating the Start-up Time, Rise Time, and Hold-up Time

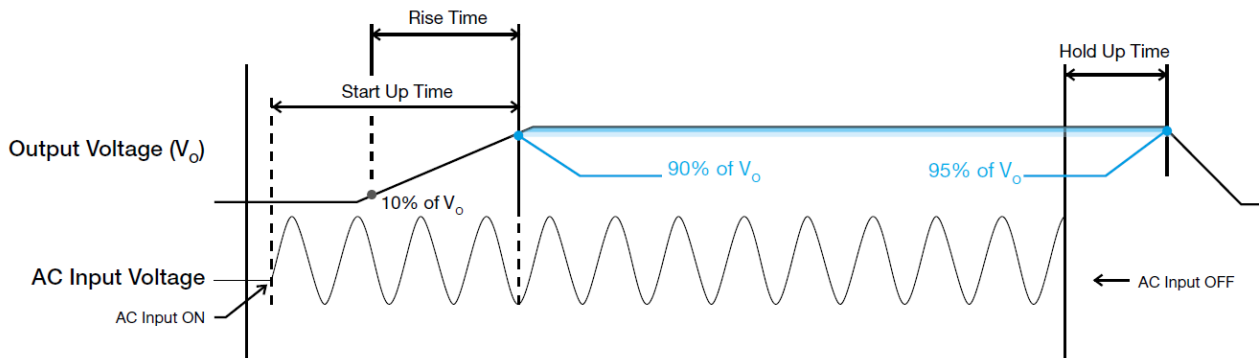

Inrush Current

Inrush current is the peak, instantaneous, input current measured and, occurs when the input voltage is first applied. For AC input voltages, the maximum peak value of inrush current will occur during the first half cycle of the applied AC voltage. This peak value decreases exponentially during subsequent cycles of AC voltage.

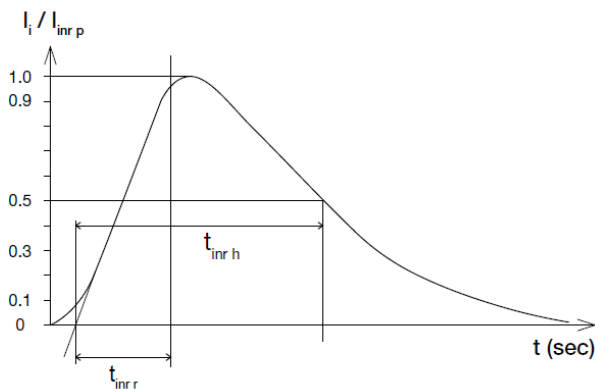

Dynamic Response

The power supply output voltage will remain within $\pm 10\%$ of its steady state value, when subjected to a dynamic load from 0 to 100% of its rated current.

50% duty cycle / 5 Hz to 1 KHz

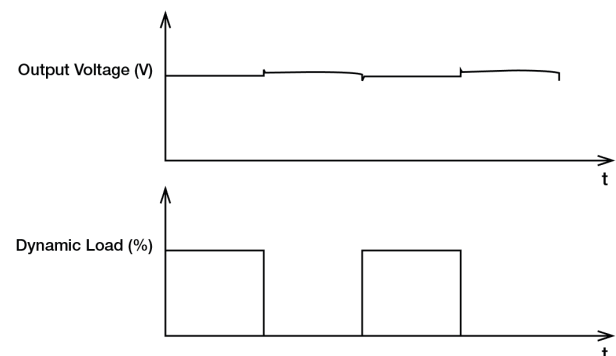

PMT Panel Mount Power Supply

5 V 35 W 1 Phase / PMT-5V35W1A□

Overload & Overcurrent Protections

The power supply's Overload (OLP) and Overcurrent (OCP) Protections will be activated when output current exceeds 105% of I_O (Max load). In such occurrence, the V_O will start to droop and once the power supply has reached its maximum power limit, the protection is activated and the power supply will go into "Hiccup mode" (Auto-Recovery). The power supply will recover once the fault condition of the OLP and OCP is removed and I_O is back within the specifications.

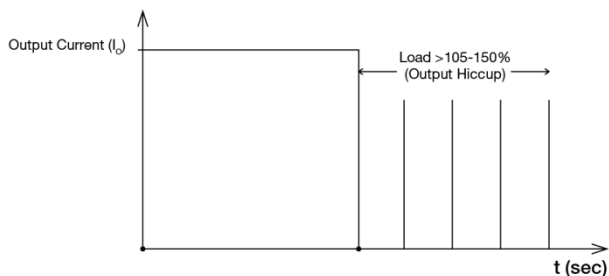

It is not recommended to prolong the duration of I_O when it is <105% but >100%, since it may cause damage to the PSU.

Short Circuit Protection

The power supply's output OLP/OCP function also provides protection against short circuits. When a short circuit is applied, the output current will operate in "Hiccup mode", as shown in the illustration in the OLP/OCP section on this page. The power supply will return to normal operation after the short circuit is removed.

Others

Attention

Delta provides all information in the datasheets on an "AS IS" basis and does not offer any kind of warranty through the information for using the product. In the event of any discrepancy between the information in the catalog and datasheets, the datasheets shall prevail (please refer to www.DeltaPSU.com for the latest datasheets information). Delta shall have no liability of indemnification for any claim or action arising from any error for the provided information in the datasheets. Customer shall take its responsibility for evaluation of using the product before placing an order with Delta.

Delta reserves the right to make changes to the information described in the datasheets without notice.

Manufacturer and Authorized Representatives Information

Manufacturer

Thailand
Delta Electronics (Thailand) PCL.
909 Pattana 1 Rd., Muang, Samutprakarn, 10280 Thailand

Taiwan
Delta Electronics, Inc.
3 Tungyuan Road, Chungli Industrial Zone, Taoyuan County
32063, Taiwan

Authorized Representatives

The Netherlands
Delta Greentech (Netherlands) B.V.
Zandsteen 15, 2132 MZ Hoofddorp, The Netherlands

United Kingdom
Delta Electronics Europe Limited
1 Redwood Court, Peel Park Campus,
East Kilbride, Glasgow, G74 5PF, United Kingdom

Overvoltage Protection

The power supply's overvoltage circuit will be activated when its internal feedback circuit fails. The output voltage shall not exceed its specifications defined on Page 3 under "Protections".

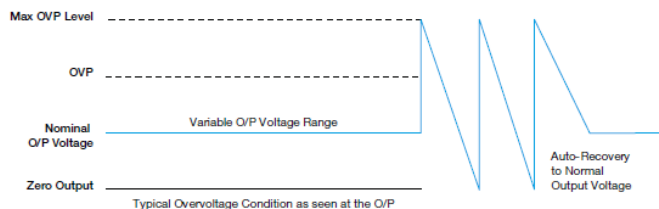

Over Temperature Protection

As mentioned above, the power supply also has Over Temperature Protection (OTP). In the event of a higher operating temperature at 100% load, the power supply will run into OTP when the operating temperature is beyond what is recommended in the de-rating graph. When activated, the output voltage will go into bouncing mode until the temperature drops to its normal operating temperature as recommended in the de-rating graph.

X-ON Electronics

Largest Supplier of Electrical and Electronic Components

Click to view similar products for [Switching Power Supplies](#) category:

Click to view products by [Delta](#) manufacturer:

Other Similar products are found below :

[70841011](#) [73-551-0005](#) [73-551-0048](#) [PS3E-B12F](#) [PS3E-E12F](#) [AAD600S-4-OP](#) [R22095](#) [KD0204](#) [9021](#) [LDIN100150](#) [LPM000-BBAR-01](#)
[LPX17S-C](#) [EVS57-10R6/R](#) [FP80](#) [FRV7000G](#) [22929](#) [PS3E-F12F](#) [CQM1IA121](#) [40370121900](#) [VI-PU22-EXX](#) [40370121910](#) [LDIN5075](#)
[LPM615-CHAS](#) [LPX140-C](#) [09-160CFG](#) [70841025](#) [VPX3000-CBL-DC](#) [VI-LUL-IU](#) [LPM000-BBAR-05](#) [LPM000-BBAR-08](#) [LPM124-](#)
[OUTA1-48](#) [LPM000-BBAR-07](#) [LPM109-OUTA1-10](#) [LPM616-CHAS](#) [08-30466-1055G](#) [08-30466-2175G](#) [08-30466-2125G](#) [DMB-EWG](#)
[TVQF-1219-18S](#) [6504-226-2101](#) [CQM1IPS01](#) [SP-300-5](#) [CQM1-IPS02](#) [VI-MUL-ES](#) [22829](#) [08-30466-0065G](#) [VI-RU031-EWWX](#) [08-30466-](#)
[0028G](#) [EP3000AC48INZ](#) [VP-C2104853](#)