



Input voltage: 14.4~170V continuous
12V/200V transient
Single output: 5V, 12V, 15V, 24V, 54V
Output power: 150W

FEATURES

Electrical

- ◆ Efficiency up to 90% @110Vin
- ◆ Meet requirements of EN50155
- ◆ Package with Industry Standard Pinout
- ◆ Dimension: 2.39"×1.54"×0.5" (60.6×39×12.7mm)
- ◆ Output over-voltage protection, Output over-current protection, Over temperature protection.
- ◆ Without tantalum capacitor inside module
- ◆ Operating Baseplate Temperature: -40°C ~+105°C
- ◆ 4242VDC input to output reinforced isolation
- ◆ Applied to altitude up to 5000m

Safety & Certificate

- ◆ UL60950-1, UL62368-1
- ◆ Fire & Smoke meet EN45545
- ◆ ISO 9001, TL 9000, ISO 14001, QS 9000, OHSAS18001 certified manufacturing facility

Soldering Method

- ◆ Wave soldering
- ◆ Hand soldering

Recommended Part Number

Model Name	Input	Output		Eff. @ 100% Load	Others
Q80SV05030PRFA	24/48/72/110V (14.4~170V)	5V	30A	88.3% @110V	Positive on/off Unthreaded mounting hole
Q80SV12013PRFA		12V	12.5A	90% @110V	
Q80SV15010PRFA		15V	10A	89.5% @110V	
Q80SV24006PRFA		24V	6.3A	89.3% @110V	
Q80SV54003PRFA		54V	2.8A	89.5% @110V	

Part Numbering System

Q	80	S	V	xxxxx	P	R	F	A
Form Factor	Input Voltage	Number Of Outputs	Product Series	Output Voltage & Current	ON/OFF Logic	Pin Length	Option Code	Option Code
Q - 1/4 Brick	80 - 14.4~170V	S - Single	V - Series Number	05030 - 5.0V & 30A 12013 - 12V & 12.5A 15010 - 15V & 10A 24006 - 24V & 6.3A 54003 - 54V & 2.8A	P - Positive N - Negative	R - 0.170"	F - RoHS 6/6 (Lead Free)	A - unthreaded mounting hole S - with threaded mounting hole(M3*0.5)

Attribute		Model	Q80SV05030	Q80SV12013	Q80SV15010	Q80SV24006	Q80SV54003
INPUT	Voltage	Continuous	14.4~170Vdc				
		Transient	12V-14.4V/1s, 170V-200V/1s				
	Current	@14.4Vin, full load	13A	12.5A	12.5A	12.5A	12.5A
		@110Vin, No load	20mA	20mA	20mA	20mA	20mA
		@Enable off & 110V	15mA				
Efficiency	110Vin, 100% load	88.3%	90.0%	89.5%	89.3%	89.5%	
	110Vin, 60% load	87.1%	88.5%	88.5%	88.6%	88.1%	
OUTPUT	Voltage Setting (72Vin,full load, 25°C)		5V±1%	12V±1%	15V±1%	24V±1%	54V±1%
	Current Rating		0~30A	0~12.5A	0~10.0A	0~6.3A	0~2.8A
	Voltage trim range ^{Note1}		-20~10%	-20~10%	-20~10%	-20~18%	-20%~10%
	Ripple & Noise Vpp ^{Note2}		<1.5%	<1.5%	<3%	<1.5%	<1.5%
	Output Regulation	Line	0.2% Max				
		Load	0.2% Max				
		Temperature	0.004%/°C				
	Start-up Time ^{Note3}	Delay from input	250ms				
		Delay from on/off	250ms				
		Rise time	50ms	25ms	50ms	50ms	55ms
	Transient response ^{Note4}	Voltage deviation	5%				
Response time		<1ms					
Output capacitance		0~ 10000uF	0~ 10000uF	100~ 5000uF	0~ 5000uF	0~ 1000uF	
PROTECTION	Output Over Current (hiccup)		110%~190% Iomax				
	Output Over Voltage (hiccup)		6~10V	14~17V	18~24V	30~36V	60~75V
	Input UVLO	On threshold	12.2~13.8V				
		Off threshold	9.5~12V				
		Hysteresis	2.2V				
	OTP shutdown	NTC temperature	125 °C				
Restart Hysteresis		15 °C					
ISOLATION	Voltage, Input to Output		4242Vdc				
	Voltage, Input to baseplate		2250Vdc				
	Voltage, Output to baseplate		2250Vdc				
	Resistance (at 500Vdc)		100 MΩ min				
ENVIRONMENT	Operating ambient temperature		-40~85°C				
	Operating baseplate temperature		-40~105°C				
	Storage temperature		-40~125°C				
	Operating Humidity		Max 95%				
	Shock & Vibration		EN 61373				
Enable control	Logic low		-0.7~-0.8V				
	Logic high		2.5-5V				
	Current (V _{on/off} =0V)		1mA max				
	Voltage when floating		<10V				
Others	Switching Frequency		250kHz				
	MTBF (72Vin,80% load,25°C)		597K hours				
	Weight		88g				
	Altitude		5000m				

Notes (All specifications valid at 72Vin,100% Rated load and 25°C ambient, unless otherwise indicated.)

*1 Maximum output power & current of the module should not over rated output power & current.

*2 Ripple & Noise measurement bandwidth is 0-20MHz, Vin=72V, full load, Cout=100uF polymer +4.7uF ceramic.

*3 "Delay from input": from Vin reaching turn-on threshold to 10% Vout (pre-applied enable);

"Delay from on/off": From enable to 10% Vout (pre-applied Vin); "Rise time" From 10% to 90% Vout.

*4 Load transient test condition: 72Vin, 50% to 75% full load, 100uF Polymer Capacitor load cap, 0.1A/us.

*5 Define that the maximum Vin rising rate is 100V/ms and the recommend output capacitance is 100uF.

*6 The recommended external input capacitance is 100uF.

Mechanical Drawing

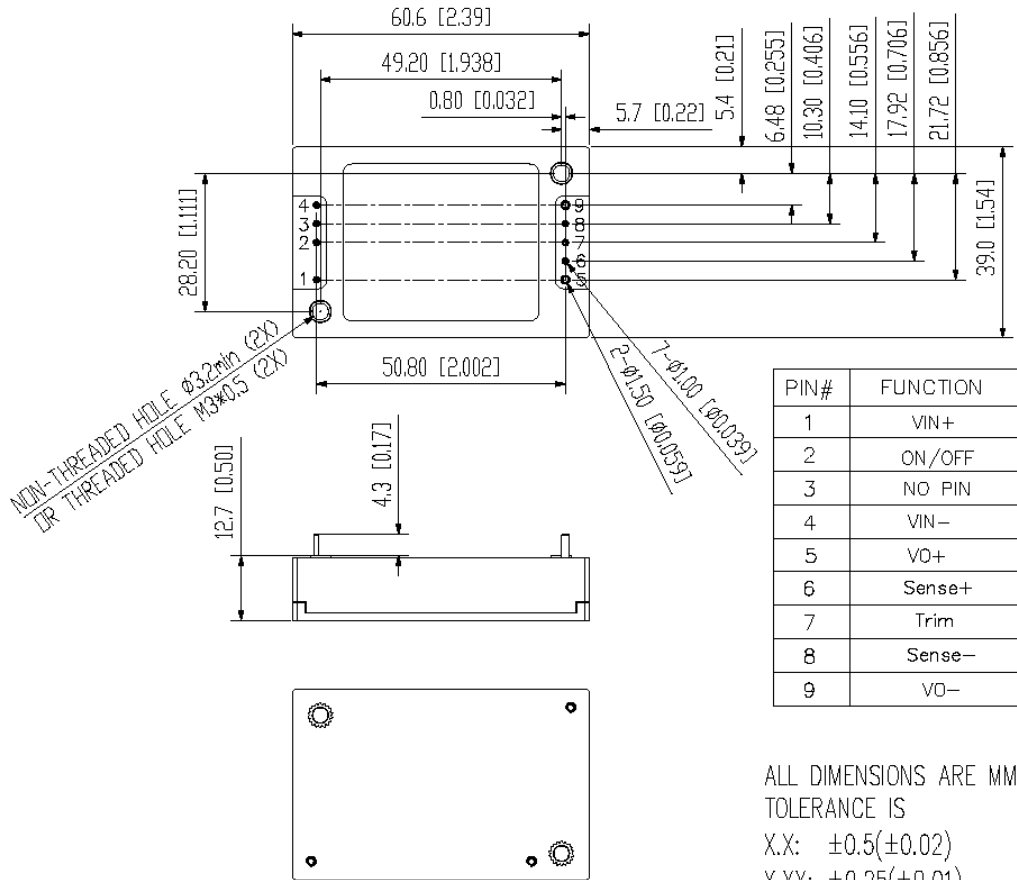

Recommended Pad Layout

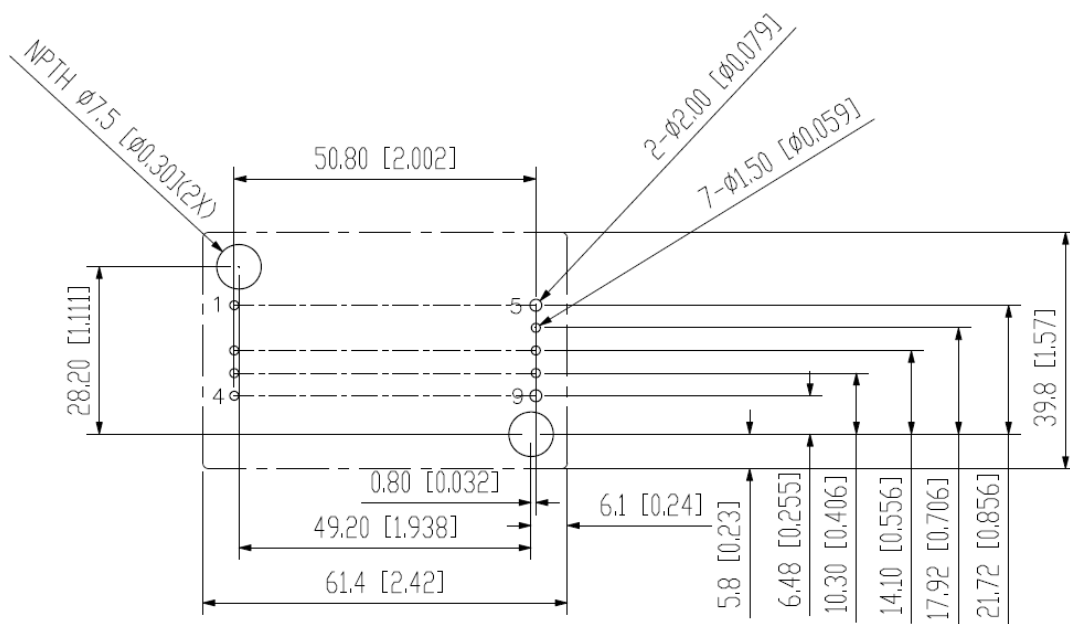

Typical EMI Filter Circuit for EN55032 Class A Conducted Emission

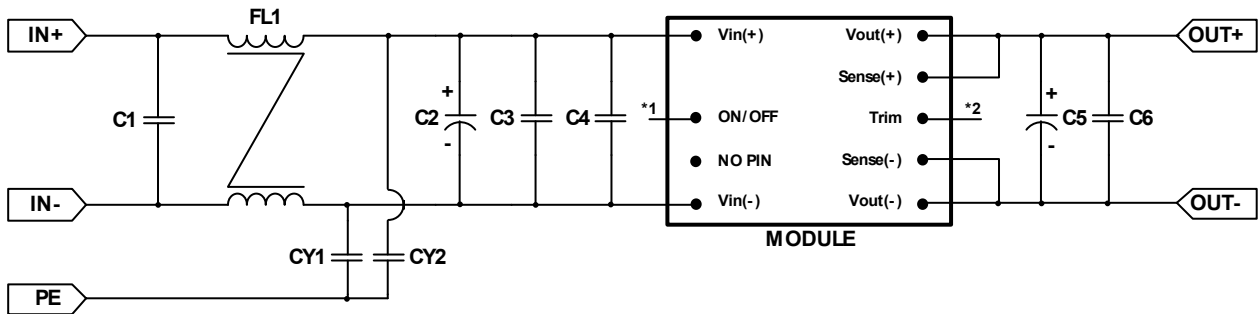

* Compliance to EN50155

* 1, 2: Please refer to page12 for the remote On/Off (pin2) and Trim (pin7) implementation.

Location	Vendor P/N	Description	Qty	Vendor	Purpose
C1	D3D2H505KB00352	500V 5uF K S27.5 32*11*20	2	FARATRONIC	EMC
FL1	PH9455.155NL	19A 1.62mH NPB SRF 10MHz	1	Pulse	EMC
CY1	CS12-F2GA472MYNSAC	250VAC 4700pF M F VI7.5	5	TDK	EMC
CY2	CS12-F2GA472MYNSAC	250VAC 4700pF M F VI7.5	5	TDK	EMC
C2	EKXG251EC3221MMN3S	250V 220uF M 18*31.5	1	NCC	EMC
C3	C1210X684K251TX	250V 0.68uF K X7R 1210	3	HOLY STONE	EMC
C4	GRM32DR72E104KW01L	250V 0.1uF K X7R 1210	1	MURATA	EMC
C5	100PX100MEFCT810X16	100V 100uF M 10*16	1	RUBYCON	RIPPLE
C6	C1210X475K101TX	100V 4.7uF K X7R 1210	1	HOLY STONE	RIPPLE

* The components for EMC purpose can be deleted if no EMC requirement.

1. Q80SV05030 (5V OUTPUT)

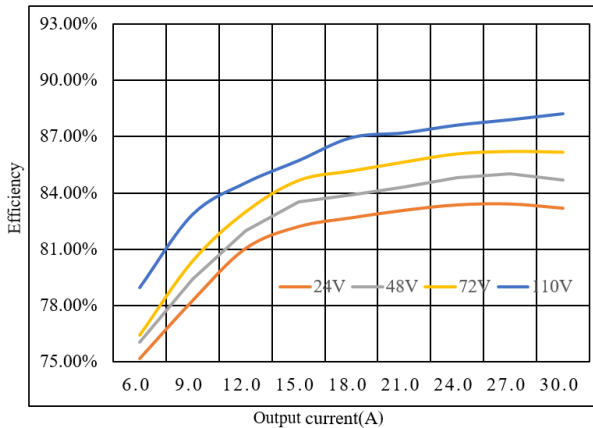

Figure 1: Efficiency vs. load current at 25°C.

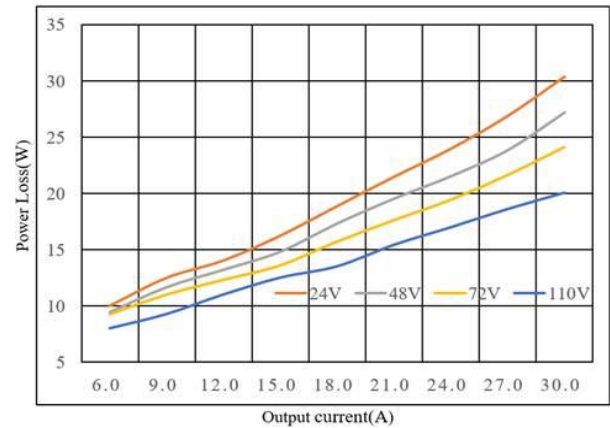

Figure 2: Power loss vs. load current at 25°C.

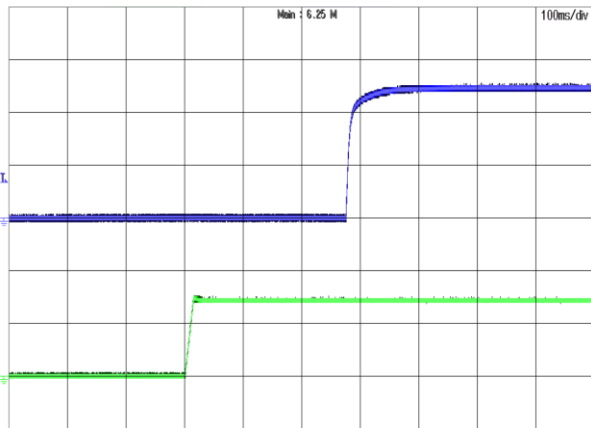

Figure 3: Turn-on transient at full load current (100ms/div).
Top Trace: Vout, 2V/div; Bottom Trace: Vin, 50V/div

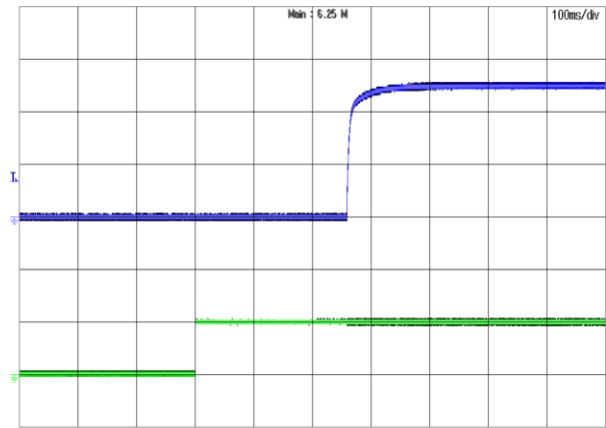

Figure 4: Turn-on transient at full load current (100ms/div).
Top Trace: Vout, 2V/div; Bottom Trace: ON/OFF, 5V/div

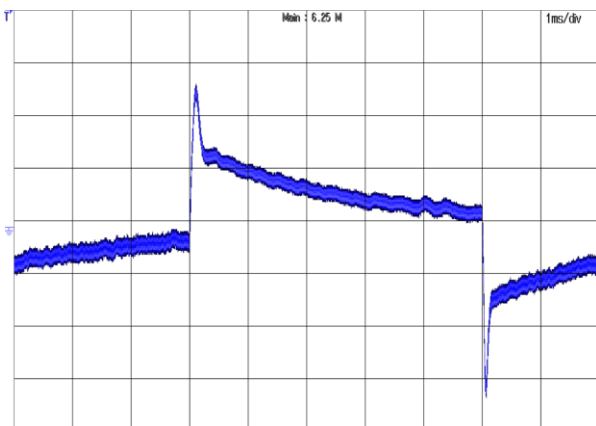

Figure 5: Output voltage response to step-change in load current (50%-75%-50% of full load; $di/dt = 0.1A/\mu s$).
Trace: Vout, 100mV/div; Time: 1ms/div

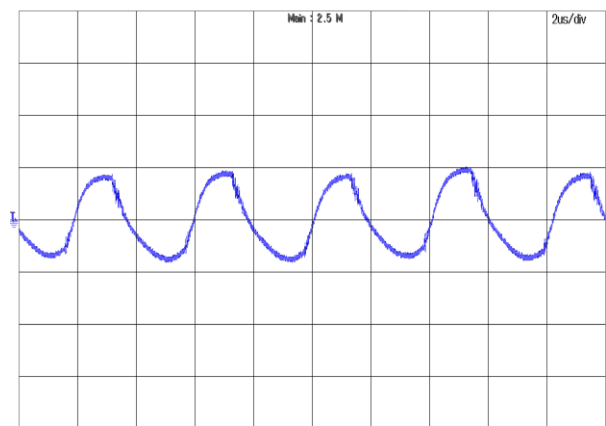

Figure 6: Output voltage ripple at $V_{in}=72V$ and full load
Trace: Vout, 20mV/div, 2us/div; Bandwidth: 20 MHz.

2. Q80SV12013 (12V OUTPUT)

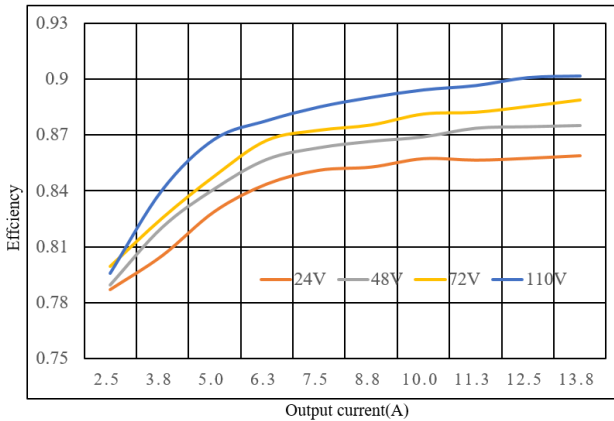

Figure 7: Efficiency vs. load current at 25°C.

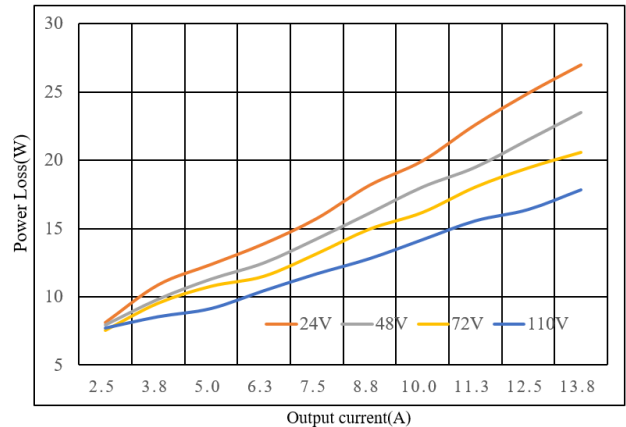

Figure 8: Power loss vs. load current at 25°C.

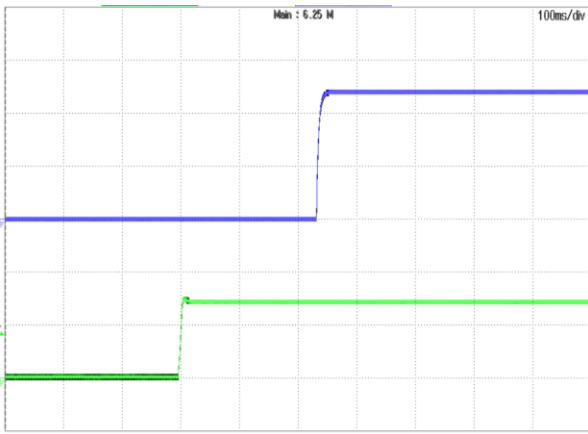

Figure 9: Turn-on transient at full load current (100ms/div).
Top Trace: Vout, 5V/div; Bottom Trace: Vin, 50V/div

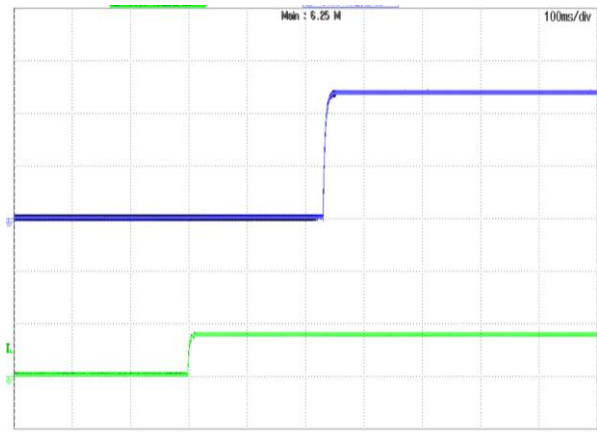

Figure 10: Turn-on transient at full load current (100ms/div).
Top Trace: Vout, 5V/div; Bottom Trace: ON/OFF, 5V/div

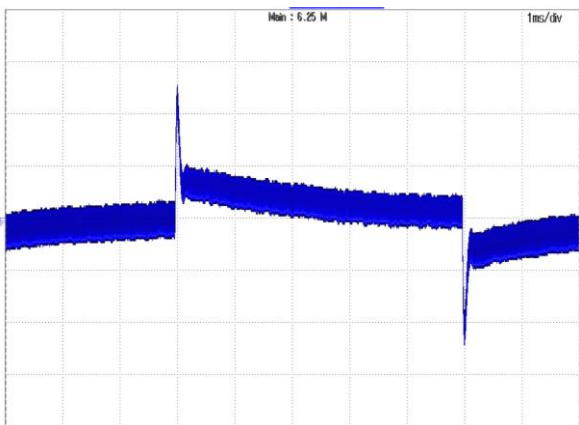

Figure 11: Output voltage response to step-change in load current (50%-75%-50% of full load; $di/dt = 0.1A/\mu s$).
Trace: Vout, 200mV/div; Time: 1ms/div

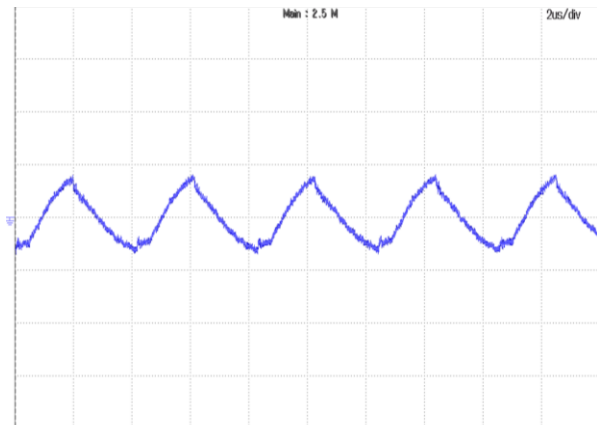

Figure 12: Output voltage ripple at $V_{in}=72V$ and full load
Trace: Vout, 100mV/div, 2us/div; Bandwidth: 20 MHz.

3. Q80SV15010 (15V OUTPUT)

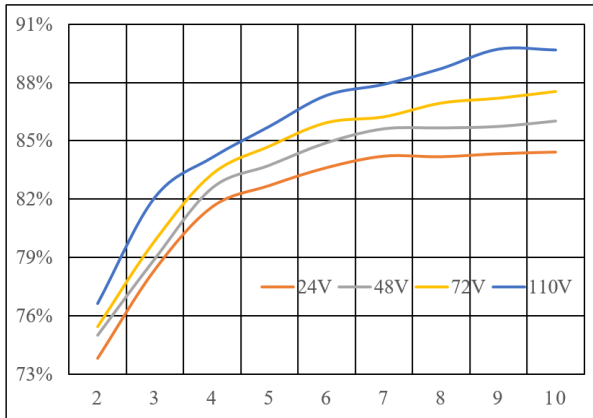

Figure 13: Efficiency vs. load current at 25°C.

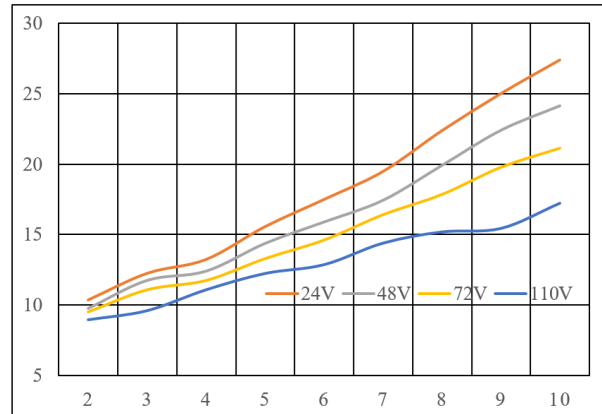

Figure 14: Power loss vs. load current at 25°C.

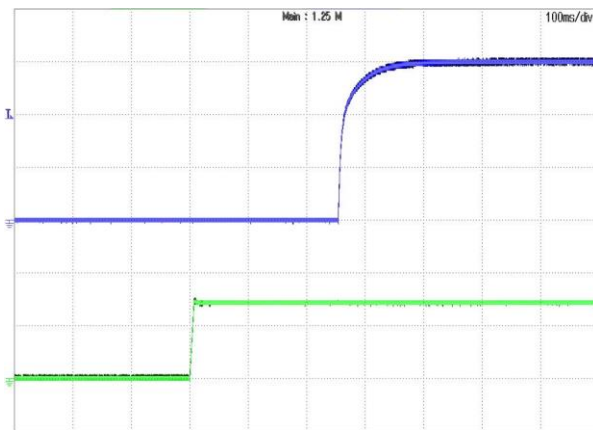

Figure 15: Turn-on transient at full load current (100ms/div).
Top Trace: Vout, 5V/div; Bottom Trace: Vin, 50V/div

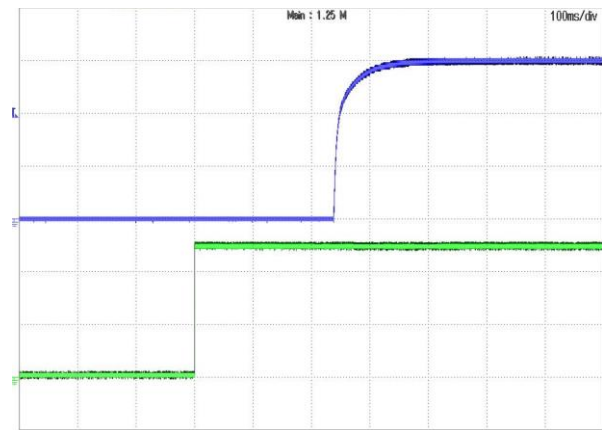

Figure 16: Turn-on transient at full load current (100ms/div).
Top Trace: Vout, 5V/div; Bottom Trace: ON/OFF, 5V/div

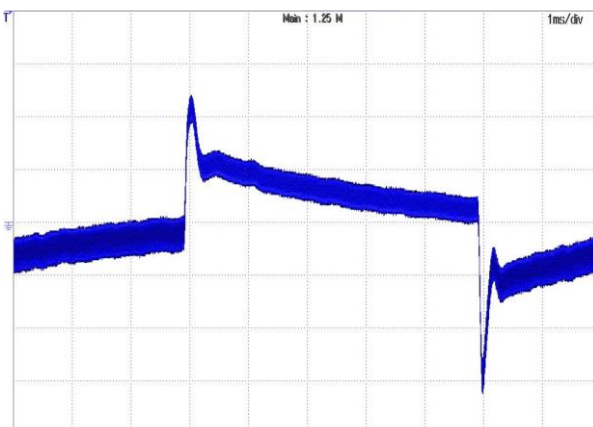

Figure 17: Output voltage response to step-change in load current (50%-75%-50% of full load; $di/dt = 0.1A/\mu s$).
Trace: Vout, 200mV/div; Time: 1ms/div

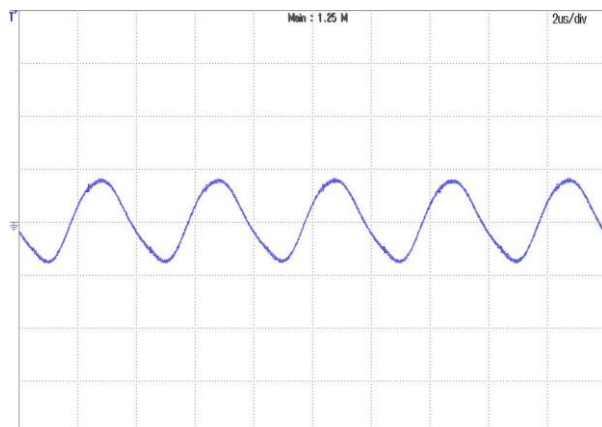

Figure 18: Output voltage ripple at $V_{in}=72V$ and full load
Trace: Vout, 100 mV/div, 2μs/div; Bandwidth: 20 MHz.

4. Q80SV24006 (24V OUTPUT)

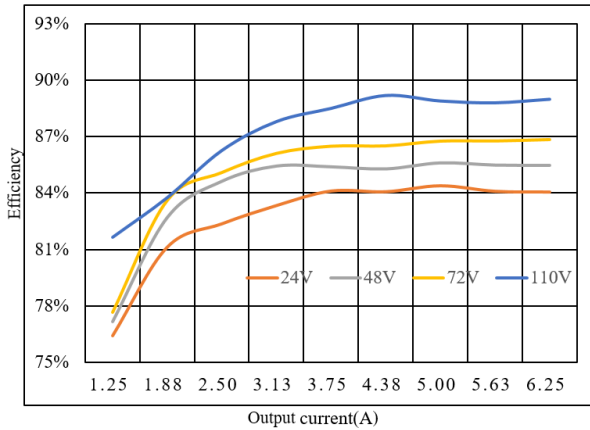

Figure 19: Efficiency vs. load current at 25°C.

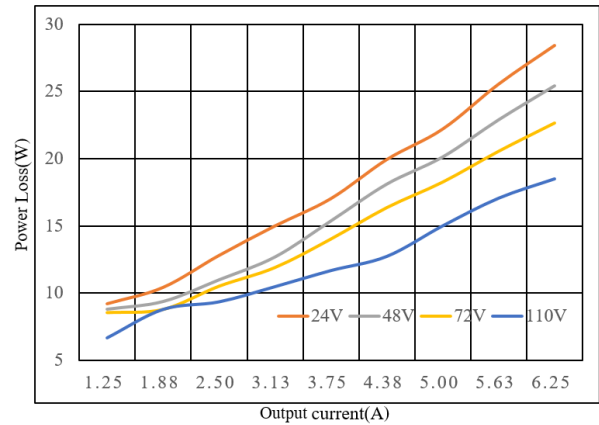

Figure 20: Power loss vs. load current at 25°C.

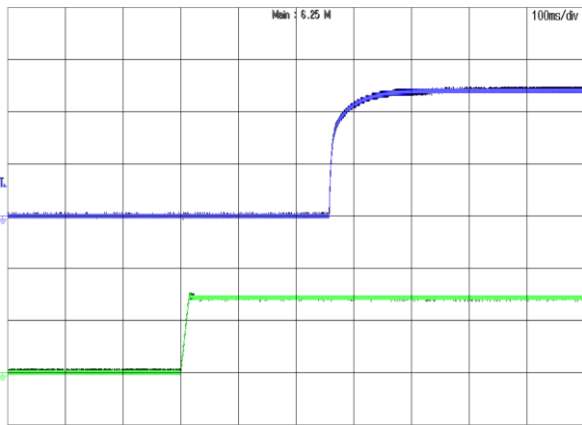

Figure 21: Turn-on transient at full load current (100ms/div).
Top Trace: Vout, 5V/div; Bottom Trace: Vin, 50V/div

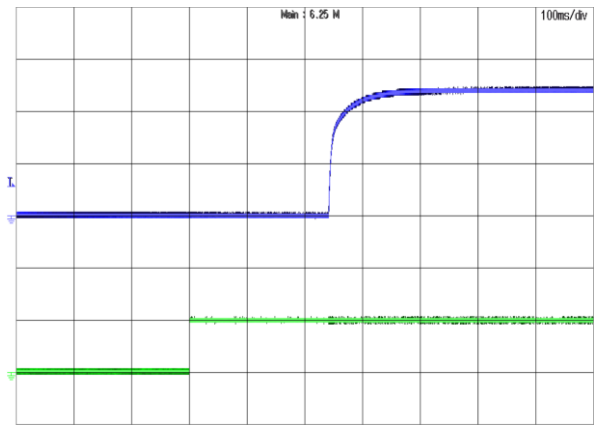

Figure 22: Turn-on transient at full load current (100ms/div).
Top Trace: Vout, 5V/div; Bottom Trace: ON/OFF, 5V/div

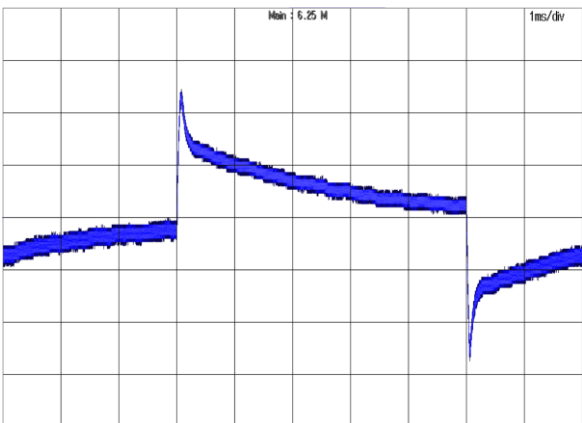

Figure 23: Output voltage response to step-change in load current (50%-75%-50% of full load; $di/dt = 0.1A/\mu s$).
Trace: Vout, 300mV/div; Time: 1ms/div

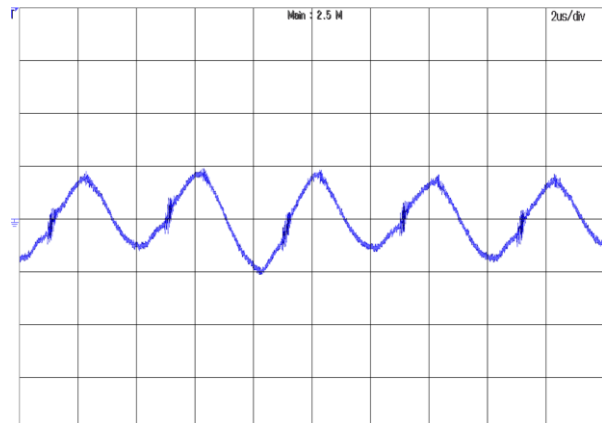

Figure 24: Output voltage ripple at $V_{in}=72V$ and full load
Trace: Vout, 100 mV/div, 2us/div; Bandwidth: 20 MHz.

5. Q80SV54003 (54V OUTPUT)

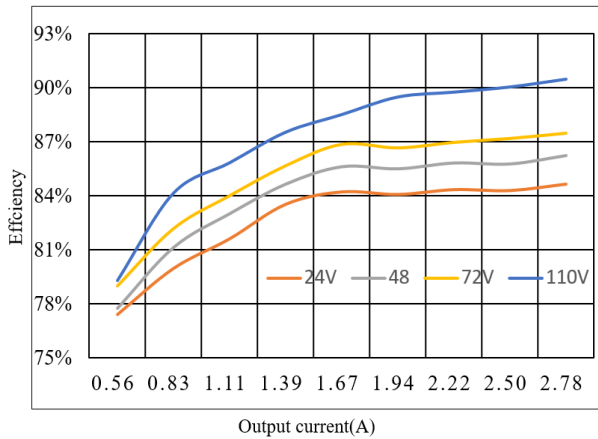

Figure 25: Efficiency vs. load current at 25°C.

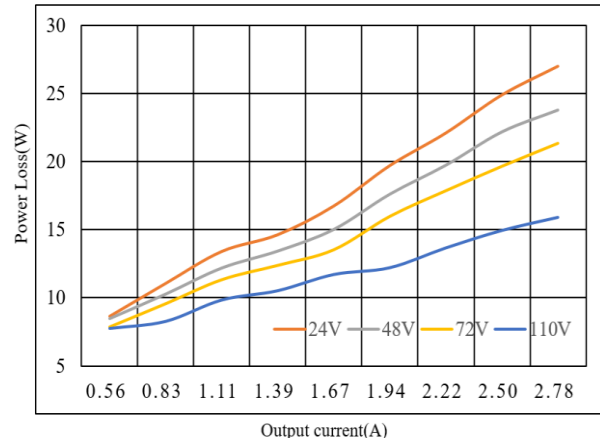

Figure 26: Power loss vs. load current at 25°C.

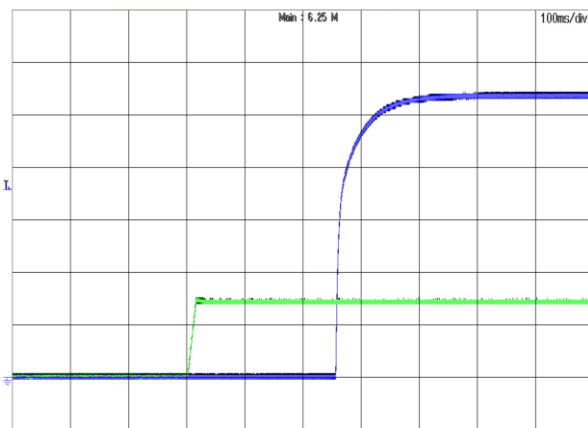

Figure 27: Turn-on transient at full load current (100ms/div).
Top Trace: Vout, 10V/div; Bottom Trace: Vin, 50V/div

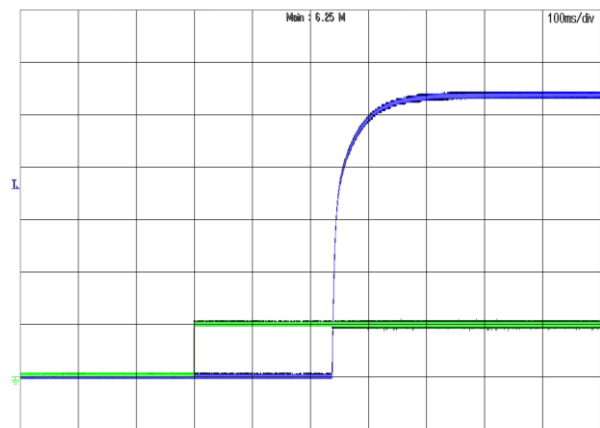

Figure 28: Turn-on transient at full load current (100ms/div).
Top Trace: Vout, 10V/div; Bottom Trace: ON/OFF, 5V/div

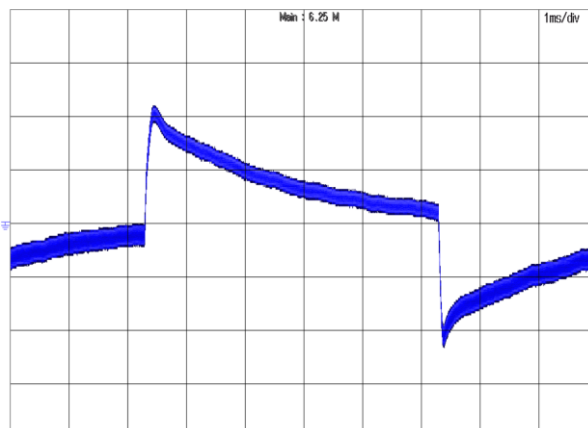

Figure 29: Output voltage response to step-change in load current (50%-75%-50% of full load; $di/dt = 0.1A/\mu s$).
Trace: Vout, 500mV/div; Time: 1ms/div

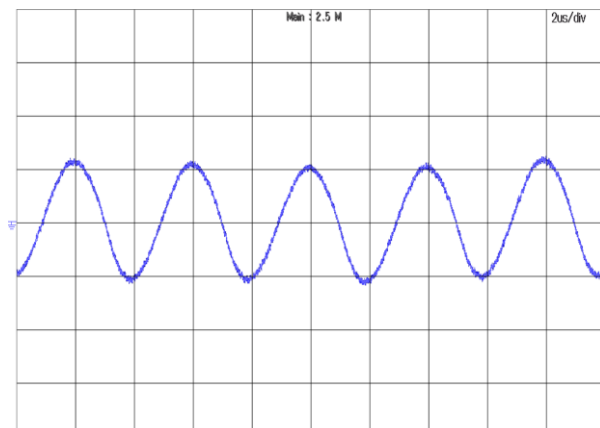
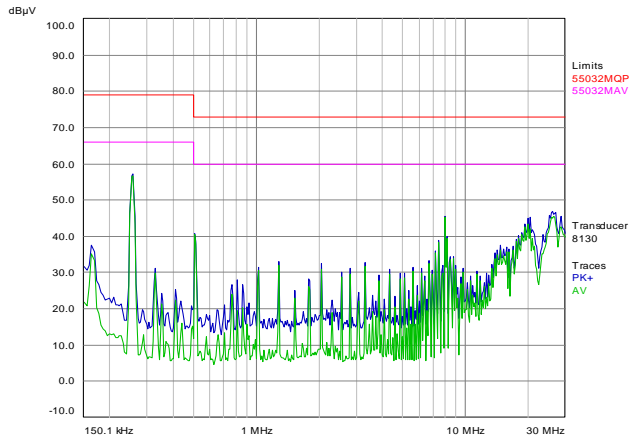

Figure 30: Output voltage ripple at $V_{in}=72V$ and full load
Trace: Vout, 100 mV/div, 2us/div; Bandwidth: 20 MHz.

Layout and EMI Considerations

Delta's DC/DC power modules are designed to operate in a wide variety of systems and applications. For design assistance with EMC compliance and related PWB layout issues, please contact Delta's technical support team.

Below is the EN55032 Class A Conducted Emission test result using typical EMI filter circuit.
At T = +25°C, Typical input voltage and full load.



Q80SV05030

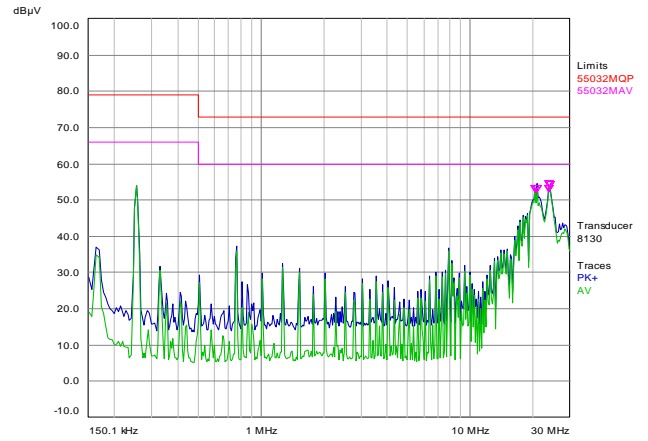

Q80SV12013

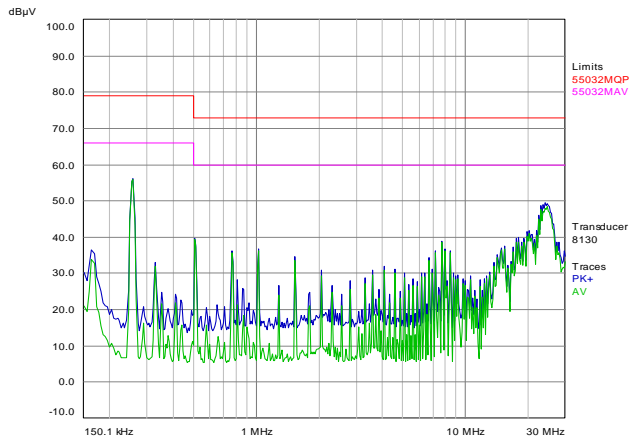

Q80SV15010

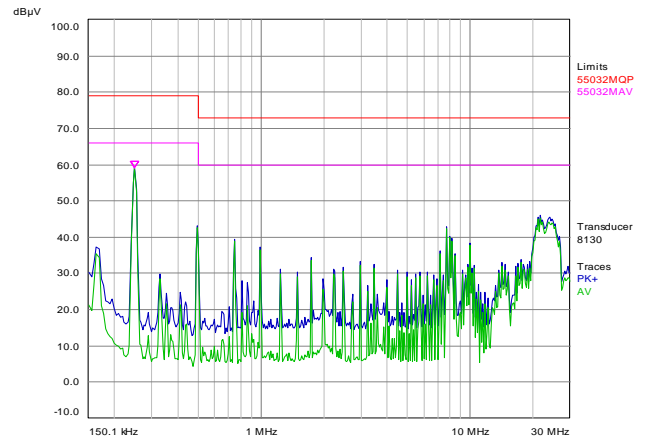

Q80SV24006

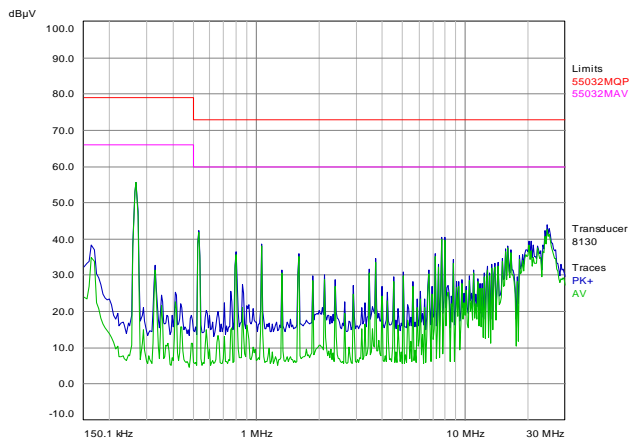

Q80SV54003

Protection Features

Over-Current Protection:

The modules include an internal output over-current protection circuit, which will endure current limiting for an unlimited duration during output overload. If the output current exceeds the OCP set point, the module will shut down, and always try to restart (hiccup mode) until the over current condition is corrected.

Over-Voltage Protection:

The modules include an internal output over-voltage protection circuit, which monitors the voltage on the output terminals. If this voltage exceeds the over-voltage set point, the module will shut down, and always try to restart until the over current condition is corrected

Over-Temperature Protection:

The over-temperature protection consists of circuitry that provides protection from thermal damage. If the over-temperature is detected the module will shut down, and restart after the temperature is within specification.

Remote On/off(Pin2):

The remote On/Off feature on the module can be either negative or positive logic depend on the part number options on the first page.

For Negative logic version: turns the module on during an external logic low and off during a logic high. If the remote on/off feature is not used, please short the On/Off pin to Vin(-).

For Positive logic version: turns the modules on during an external logic high and off during a logic low. If the remote On/Off feature is not used, please leave the On/Off pin to floating.

Remote On/Off can be controlled by an external switch between the On/Off terminal and the Vin(-) terminal. The switch can be an open collector or open drain, as showed in below picture (figure 31)

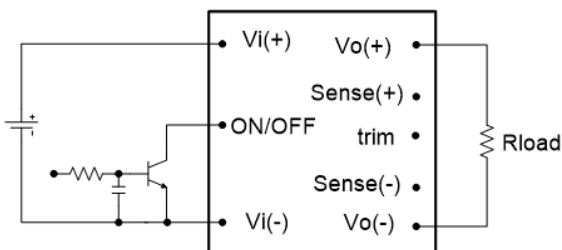

Figure 31: Remote On/Off Implementation

Trim (PIN7):

To increase or decrease the output voltage set point, connect an external resistor between the TRIM pin and SENSE (+) pin or SENSE (-) pin. The TRIM pin should be left open if this feature is not used.

Take Q80SV12013 as example, for trim down, the external resistor value required to obtain a percentage of output voltage change Δ is defined as:

$$R_{trim-down} = \left[\frac{5.11}{\Delta} - 10.22 \right] (K\Omega)$$

Ex. When Trim-down -10% ($12V \times 0.9 = 10.8V$)

$$R_{trim-down} = \left[\frac{5.11}{10\%} - 10.22 \right] (K\Omega) = 40.88(K\Omega)$$

For trim up, the external resistor value required to obtain a percentage output voltage change Δ is defined as:

$$R_{trim-up} = \left[\frac{45}{\Delta} + 40 \right] K\Omega$$

Ex. When Trim-up +10% ($12V \times 110\% = 13.2V$)

$$R_{trim-up} = \left[\frac{45}{10\%} + 40 \right] = 490(K\Omega)$$

	Rtrim-up /kohm	Rtrim-down /kohm
Q80SV05030	$\frac{15.8}{\Delta} + 10.6$	$\frac{5.11}{\Delta} - 10.22$
Q80SV12013	$\frac{45}{\Delta} + 40$	$\frac{5.11}{\Delta} - 10.22$
Q80SV15010	$\frac{57.46}{\Delta} + 52.35$	$\frac{5.11}{\Delta} - 10.22$
Q80SV24006	$\frac{95}{\Delta} + 90$	$\frac{5.11}{\Delta} - 10.22$
Q80SV54003	$\frac{220}{\Delta} + 215$	$\frac{5.11}{\Delta} - 10.22$

Safety Considerations

The power module must be installed in compliance with the spacing and separation requirements of the end-user's safety agency standard, i.e., EN 60950-1: 2006 + A11: 2009 + A1: 2010 + A12: 2011 + A2: 2013, IEC 60950-1: 2005, 2nd Edition + A1: 2009 + A2: 2013, CSA C22.2 No. 60950-1-07, 2nd Edition, 2014-10 and UL 60950-1, 2nd Edition, 2014-10-14, EN 62368-1: 2014, IEC 62368-1: 2014, CSA C22.2 No. 62368-1-14, 2nd Edition and UL 62368-1, 2nd Edition, if the system in which the power module is to be used must meet safety agency requirements.

Reinforced insulation is provided between the input and output of the module. Input is considered as secondary hazardous voltage which main transient is up to 1500Vpk and output is considered as SELV circuit. The input source must be insulated from the ac mains by reinforced or double insulation. The input terminals of the module are not considered as operator accessible.

A SELV reliability test may require when install on the system where the module is used, in combination with the module, to ensure that under a single fault, hazardous voltage does not appear at the module's output.

When installed into a Class II equipment (without grounding), spacing consideration should be given to the end-use installation, as the spacing between the module and mounting surface have not been evaluated.

This power module is not internally fused. To achieve optimum safety and system protection, an input line fuse is highly recommended. The safety agencies require a fast-blow fuse with 25A maximum rating to be installed in the ungrounded lead. A lower rated fuse can be used based on the maximum inrush transient energy and maximum input current.

Soldering and Cleaning Considerations

Post solder cleaning is usually the final board assembly process before the board or system undergoes electrical testing. Inadequate cleaning and/or drying may lower the reliability of a power module and severely affect the finished circuit board assembly test. Adequate cleaning and/or drying is especially important for un-encapsulated and/or open frame type power modules. For assistance on appropriate soldering and cleaning procedures, please contact Delta's technical support team.

Thermal Considerations

The thermal curve is based on the test setup shown as figure 32. The module is mounted on an Al plate and was cooled by cooling liquid.

Figure 33 shows the location to monitor the temperature of the module's baseplate. The baseplate temperature in thermal curve is a reference for customer to make thermal evaluation and make sure the module is operated under allowable temperature.

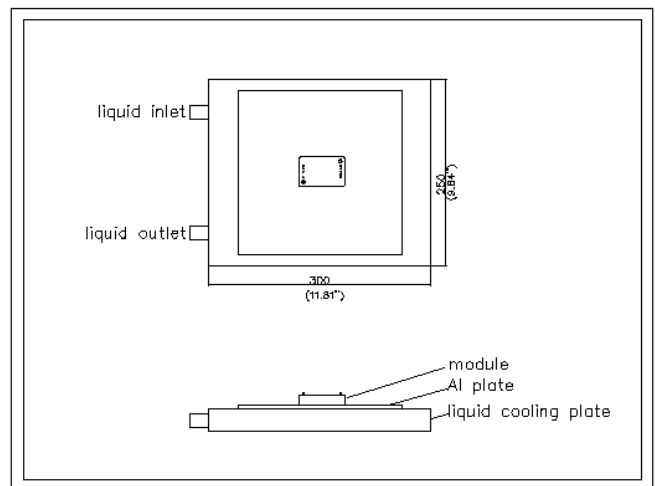

Figure 32: Thermal Test setup

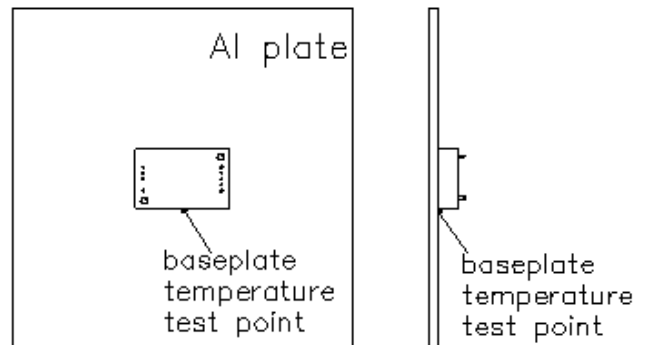

Figure 33: Temperature measured point

Thermal Curves (Base Plate Is Attached To Cold Plate)

Thermal Curves (Q80SV05030)

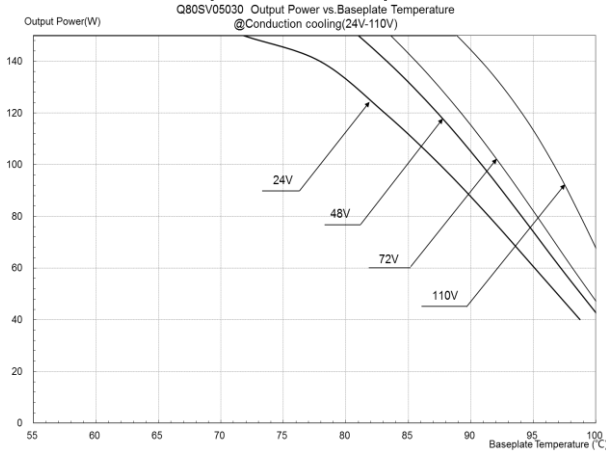

Figure 34: Output power vs. base plate temperature
@ $V_{in}=24\sim 110V$ $V_{out}=5V$

Thermal Curves (Q80SV12013 & Q80SV15010)

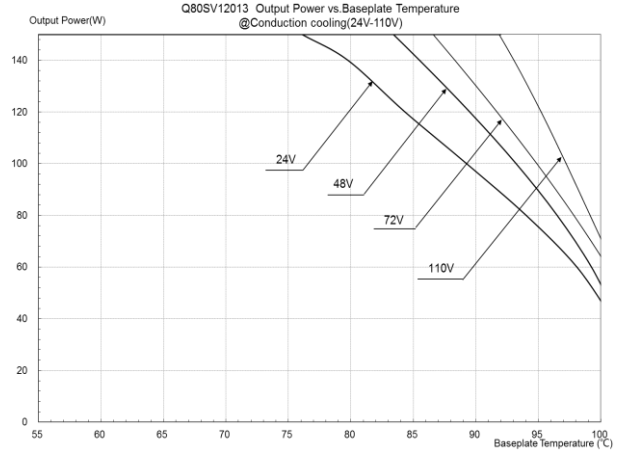

Figure 35: Output power vs. base plate temperature
@ $V_{in}=24\sim 110V$ $V_{out}=12V$ or $15V$

Thermal Curves (Q80SV24006)

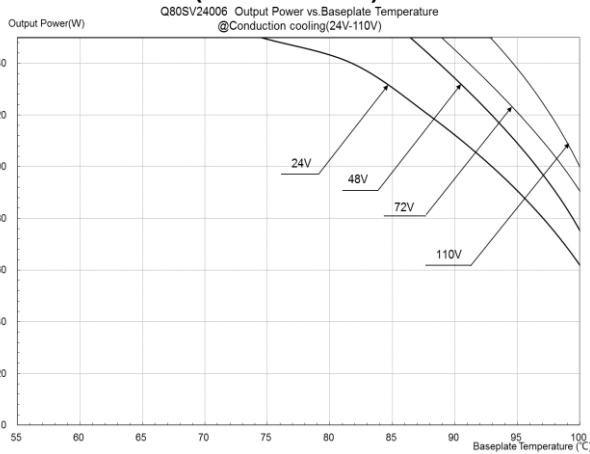

Figure 36: Output power vs. base plate temperature
@ $V_{in}=24\sim 110V$ $V_{out}=24V$

Thermal Curves (Q80SV54003)

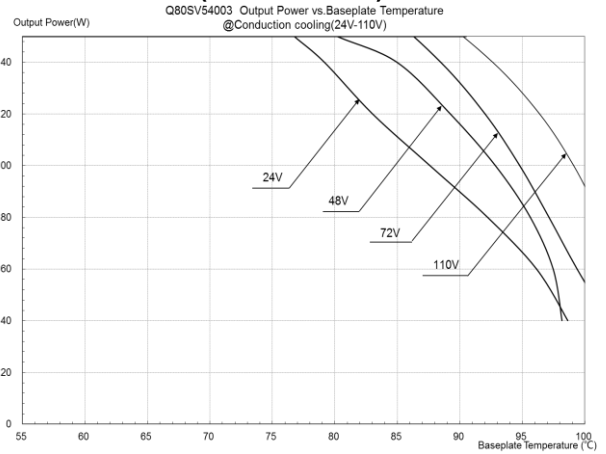

Figure 37: Output power vs. base plate temperature
@ $V_{in}=24\sim 110V$ $V_{out}=54V$

Soldering Method

Generally, as the most common mass soldering method for the solder attachment, wave soldering is used for through-hole power modules and reflow soldering is used for surface-mount ones. Delta recommended soldering methods and process parameters are provided in this document for solder attachment of power modules onto system board. SAC305 is the suggested lead-free solder alloy for all soldering methods. The soldering temperature profile presented in this document is based on SAC305 solder alloy.

Reflow soldering is not a suggested method for through-hole power modules due to many process and reliability concerns, and reflow is prohibited for potting model.

Wave Soldering (Lead-free)

Delta's power modules are designed to be compatible with single-wave or dual wave soldering. The suggested soldering process must keep the power module's internal temperature below the critical temperature of 217°C continuously. The recommended wave-soldering profile is shown below:

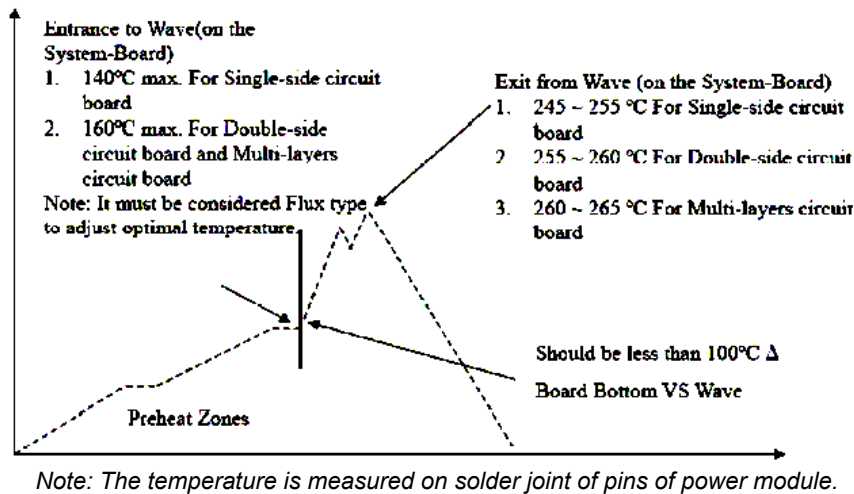

The typical recommended (for double-side circuit board) preheat temperature is 115+/-10°C on the top side (component side) of the circuit board. The circuit-board bottom-side preheat temperature is typically recommended to be greater than 135°C and preferably within 100°C of the solder-wave temperature. A maximum recommended preheat up rate is 3°C/s. A maximum recommended solder pot temperature is 255+/-5°C with solder-wave dwell time of 3~6 seconds. The cooling down rate is typically recommended to be 6°C/s maximum.

Hand Soldering (Lead Free)

Hand soldering is the least preferred method because the amount of solder applied, the time the soldering iron is held on the joint, the temperature of the iron, and the temperature of the solder joint are variable. The recommended hand soldering guideline is listed in Table below. The suggested soldering process must keep the power module's internal temperature below the critical temperature of 217°C continuously.

Parameter	Single-side Circuit Board	Double-side Circuit Board	Multi-layers Circuit Board
Soldering Iron Wattage	90	90	90
Tip Temperature	385+/-10°C	420+/-10°C	420+/-10°C
Soldering Time	2 ~ 6 seconds	4 ~ 10 seconds	4 ~ 10 seconds

CONTACT: www.deltaww.com/dcdc

USA:

Telephone:
East Coast: 978-656-3993
West Coast: 510-668-5100
Fax: (978) 656 3964

Email: dcdc@deltaww.com

Europe:

Phone: +31-20-655-0967
Fax: +31-20-655-0999

Asia & the rest of world:

Telephone: +886 3 4526107
ext 6220~6226
Fax: +886 3 4513485

WARRANTY

Delta offers a two (2) year limited warranty. Complete warranty information is listed on our web site or is available upon request from Delta.

Information furnished by Delta is believed to be accurate and reliable. However, no responsibility is assumed by Delta for its use, nor for any infringements of patents or other rights of third parties, which may result from its use. No license is granted by implication or otherwise under any patent or patent rights of Delta. Delta reserves the right to revise these specifications at any time, without notice.

X-ON Electronics

Largest Supplier of Electrical and Electronic Components

Click to view similar products for [Isolated DC/DC Converters](#) category:

Click to view products by [Delta](#) manufacturer:

Other Similar products are found below :

[ESM6D044440C05AAQ](#) [FMD15.24G](#) [PSL486-7LR](#) [Q48T30020-NBB0](#) [JAHW100Y1](#) [SPB05C-12](#) [SQ24S15033-PS0S](#) [18952](#) [19-130041](#)
[CE-1003](#) [CE-1004](#) [GQ2541-7R](#) [RDS180245](#) [MAU228](#) [J80-0041NL](#) [DFC15U48D15](#) [XGS-0512](#) [XGS-1205](#) [XGS-1212](#) [XGS-2412](#) [XGS-2415](#) [XKS-1215](#) [06322](#) [NCT1000N040R050B](#) [SPB05B-15](#) [SPB05C-15](#) [L-DA20](#) [DCG40-5G](#) [QME48T40033-PGB0](#) [XKS-2415](#) [XKS-2412](#)
[XKS-1212](#) [XKS-1205](#) [XKS-0515](#) [XKS-0505](#) [XGS-2405](#) [XGS-1215](#) [XGS-0515](#) [PS9Z-6RM4](#) [73-551-5038I](#) [AK1601-9RT](#) [VI-N61-CM](#) [VI-R5022-EXWW](#) [PSC128-7iR](#) [RPS8-350ATX-XE](#) [DAS1004812](#) [PQA30-D24-S24-DH](#) [VI-M5F-CQ](#) [VI-LN2-EW](#) [VI-PJW01-CZY](#)