

# LED Driver

## USCI LITE



# USCI LITE

### Highlights & Features

- Constant current design
- Programmable output current through programming tool
- 6kV Combi-wave surge rating meet ANSI C82.77-5
- UL LISTED, Class P & Type HL , UL Dry & Damp
- 0 -10V dimming available
- 50,000hours lifetime

### Safety Standards



**Class P**  
**LED Class 2 Output**  
**For Dry and Damp Location**

Class2 of UL1310 for 55W

**Model Number: USCI-□□□□□GB**

**Dimensions (L x W x H):**

USCI-055180GB	6.59" x 2.36" x 1.5" (167.5 x 60.0 x 37.5mm)
USCI-100140GB	6.59" x 2.36" x 1.5" (167.5 x 60.0 x 37.5mm)
USCI-200140GB	9.45" x 2.36" x 1.5" (240.0 x 60.0 x 37.5mm')

### General Description

Delta LED drivers come in different series to suit different application needs. The USCI LITE series features programmable output current level. USCI LITE series offers the capability to achieve different level of LED brightness via built-in 1-10V dimming function to meet various application and energy optimization needs. The products are designed and rigorously tested to work with various outdoor LED lighting conditions. Featuring high surge immunity (CM: 6kV, DM: 6kV) and complying to Dry and Damp location.

### Model Information

USCI LITE LED Driver

Model Number	Input Voltage Range	Rated Output Voltage	Programmable Output Current	Constant Power Current
USCI-055180GB	120-277Vac Typical 108-305Vac Range	18-52.4Vdc	520-1800mA	1050-1800mA
USCI-100140GB		50-143Vdc	600-1400mA	700-1400mA
USCI-200140GB		75-190Vdc	600-1400mA	1050-1400mA

### Model Numbering

US	C	I	-	□□□	□□□	GB
Safety Approval - UL,	Constant current	Outdoor		Output Power 055:55W 100:100W/ 200:200W	Max Output Current 140 – 1400mA 180 – 1800mA	Programmable output current 0-10V dimming

# LED Driver

## USCI LITE

### Specifications

Model Number	USCI-055180GB	USCI-100140GB	USCI-200140GB
--------------	---------------	---------------	---------------

### Input Ratings / Characteristics

Normal Input Voltage	120-277Vac			
Input Voltage Range	108-305Vac			
Normal Input Frequency	50-60Hz			
Input Frequency Range	47-63Hz			
Max. Input Current	120Vac	0.6A	1.04A	2.1A
	277Vac	0.26A	0.43A	0.81A
Efficiency <sup>1)</sup>	120Vac	88%@1.05A	90.5%@0.7A	91.5%@1.05A
	277Vac	90%@1.05A	92.5%@0.7A	93.5%@1.05A
Inrush Current @ Cold Start	120Vac	50A/150uS	100A/150uS	100A/150uS
	277Vac	100A/150uS	200A/150uS	200A/150uS
Power Factor	> 0.9 @Full Load			
Total Harmonic Distortion	THD < 20% @Full Load			
Leakage Current	< 0.75mArms per UL8750			

1) 100% Load (typical) and tested after 30 minutes warm up.

### Output Ratings / Characteristics

Output Voltage Range	18-52.4Vdc	50-143Vdc	75-190Vdc
Max. No Load Output Voltage	60Vrms	171Vrms	230Vrms
Output Power Range	55W	100W	200W
Adjustable Output Current (AOC)	520-1800mA	600-1400mA	600-1400mA
	With steps of 1mA, configurable via software		
Minimum Output Current	10% of AOC		
Current Accuracy	± 5% (@ Typical output current range)		
Output Current LF Ripple	15% (ripple = peak-average/average) and Low frequency (≤120 Hz) <5% @Full Load		
Start-up Time	1000ms max. @ 120-277Vac @Full Load		

# LED Driver

## USCI LITE

<b>Model Number</b>	USCI-055180GB	USCI-100140GB	USCI-200140GB
---------------------	---------------	---------------	---------------

### Mechanical

Casing	Steel case, color : Black		
Dimensions (L x W x H) [inch] [mm]	6.59" x 2.36" x 1.5" (167.5 x 60.0 x 37.5mm)	9.45" x 2.36" x 1.5" (240.0 x 60.0 x 37.5mm)	
Unit Weight [lb] / [kg]	1.83 / 0.83	2.53 / 1.15	
Cooling System	Convection		
Input Cable	L: Black, N: White; UL1316 18AWG solid copper wires Length 300mm		
Output Cable	Positive: Red ; Negative: Black (55W), Blue (100 / 200W) ; NTC/PRG: Orange ; UL1316 18AWG solid copper wires Length 300mm		
Dimming Cable	Dim(+): Purple, Dim(-): Pink ; UL1316 18AWG solid copper wires Length 300mm		
Noise	Sound Pressure Level (SPL) < 24dBA (30cm distance)		

### Environment

Ambient Temperature	Operating	-40°C to +55°C		
	Storage	-40°C to +85°C		
Maximum Case Temperature	+85°C	+85°C	+90°C	
Relative Humidity	Operating	10 to 90% RH (Non-Condensing)		
	Storage	5 to 95% RH (Non-Condensing)		
Environmental Locations	Dry & Damp , Type HL			

### Protections

Over Voltage	60Vrms	171Vrms	230Vrms
	Auto-Recovery when the fault is removed		
Overload / Overcurrent	Reduce output current. Auto-Recovery when the fault is removed		
Short Circuit	Auto-Recovery when the fault is removed		
Over Temperature	Reduce output current. Auto-Recovery when the fault is removed		
Case connection	Case must be grounding		

### Reliability Data

Lifetime	50,000 hours at case temp. tc & full load. Refer to "Lifetime VS Case Temperature"		
Lifetime @ tc	+85°C	+75°C	+80°C

# LED Driver

## USCI LITE

<b>Model Number</b>	USCI-055180GB	USCI-100140GB	USCI-200140GB
---------------------	---------------	---------------	---------------

### Safety Standards / Directives

Electrical Safety	UL 8750, UL List, Class P, Class2 of UL1310 for 55W			
Material and Parts	RoHS Directive 2011/65/EU Compliant			
	Main	Output	1-10V dim	Case
Main	N/A	2U + 1000V	2U + 1000V	2U + 1000V
Output	2U + 1000V	N/A	2U + 1000V	2U + 1000V
1-10V dim	2U + 1000V	2U + 1000V	N/A	2U + 1000V
Case	2U + 1000V	2U + 1000V	2U + 1000V	N/A

### EMC Compliance

Emissions (CE & RE)	Compliance to 47 CFR FCC Part 15, Subpart B, Class A Compliance to CAN ICES-005(A) / NMB-005(A)
Surge	Compliance to ANSI C82.77-5 CAT C low 6KV Meet Criteria A or B

1) Criteria A: Normal performance within the specification limits

2) Criteria B: Temporary degradation or loss of function, which is self-recoverable

### 1-10V Dimming Specification

Absolute Maximum Voltage	± 20V
Source Current	100µA (typ)
Dimming Input Range	(1)1-10V for 10-100% dimming and 1V for 10% of $I_{o\_set}$ and ≥ 8.5V is 100% of $I_{o\_set}$ (2) Short is 10% of $I_{o\_set}$ (or 100mA minimum) & Open is 100% (3)See 1-10V Dimming Curve

### Default Settings of the Driver (can be configured with programming tool)

Adjustable Output Current (AOC)	1050mA	700mA	1050mA
Smart Timer DIM	Disabled Smart Time Dim		
Module Temperature Protection (MTP)	Disabled. Configurable though programming tool		
Constant Lumen Output (CLO)	Disabled. Configurable though programming tool		
End of Life indication (EOL)	Disabled. Configurable though programming tool		

# LED Driver

## USCI LITE

<b>Model Number</b>	USCI-055180GB	USCI-100140GB	USCI-200140GB
---------------------	---------------	---------------	---------------

### Smart Timer Dim

Provides three operation modes: Fixed Timer, Midnight Centric Timer, Ratio Rescale Timer.

#### Fixed Timer

It is a memoryless-based dimming mode that tracks the output level based on the programmed timing curve. The output level is organized by scheduled profile in five steps.

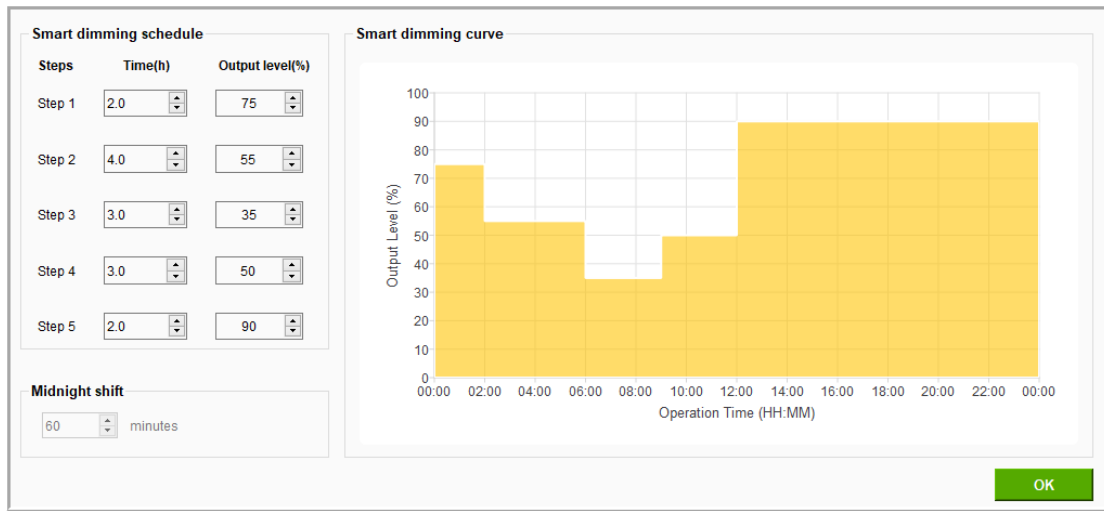

#### Midnight Centric Timer

This mode is an memory-based that automatically measures over the past two days the power-on time of the lighting installation at which is the naturally corresponded to night time. The Midnight Centric Timer software calculates the length of power on time and centralized from the given virtual midnight point and change the output level accordingly. More specifically, when the LED driver is power-on during the very first two days or the power-on time difference of past two days is more than 15 minutes, the output current will fixed to the maximum level since there is no valid (reasonable) data for reference. Start from the third day and so on, when the power-on time difference of past two days is less than 15 minutes, the output level is controlled based on the correlation between the midnight point of programmed profile and yesterday power-on duration.

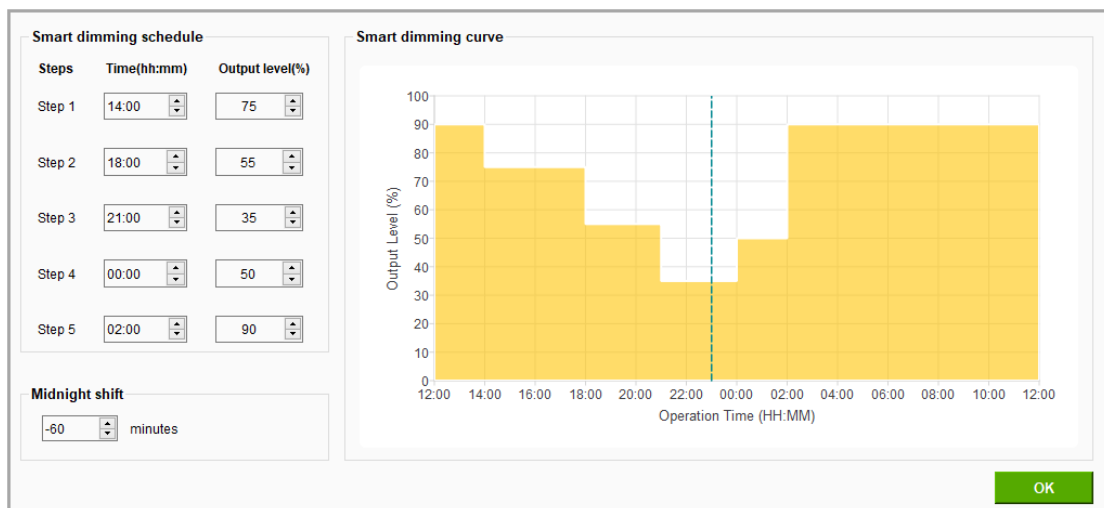

# LED Driver

## USCI LITE

### Ratio Rescale Timer

This mode is similar to Midnight Centric Timer that records the power-on time based on the local night time. The Ratio Rescale Timer software rescale programmed output power profile of each step by a calculated percentage of the recorded power-on time (when valid) out of given 5 steps duration.

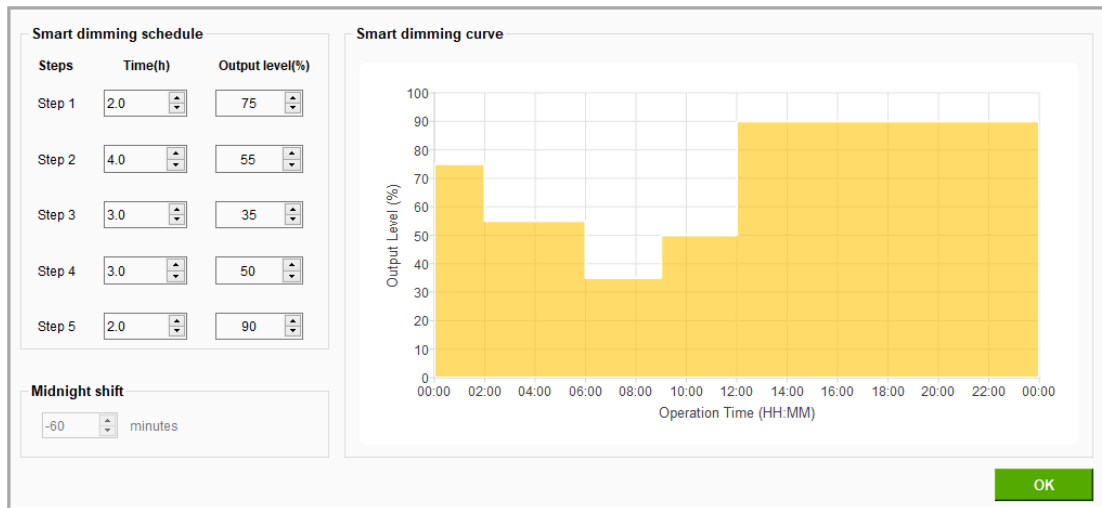

Note: When all steps are finished, the light level will remain in last level (level in step 5) for all three modes.

### Module Temperature Protection (for LED module)

In the LED luminaire system application, user can enable the MTP function by GUI and be taken to place the NTC thermistor close to the hottest spot on the LED module to avoid the abnormal high temperature on LED module. If LED thermal protection is not required the NTC wire of the LED driver can be left open. The de-rating limits can be programmed using the programming tool

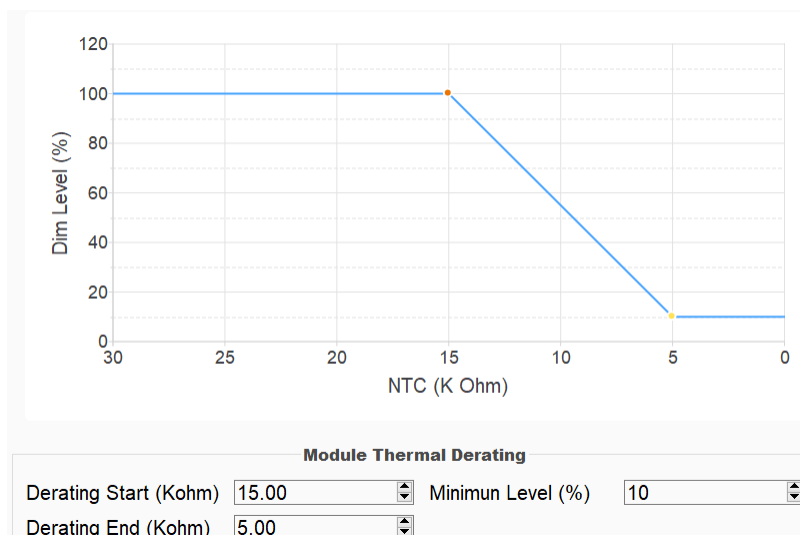

# LED Driver

## USCI LITE

### Operation Window for programming

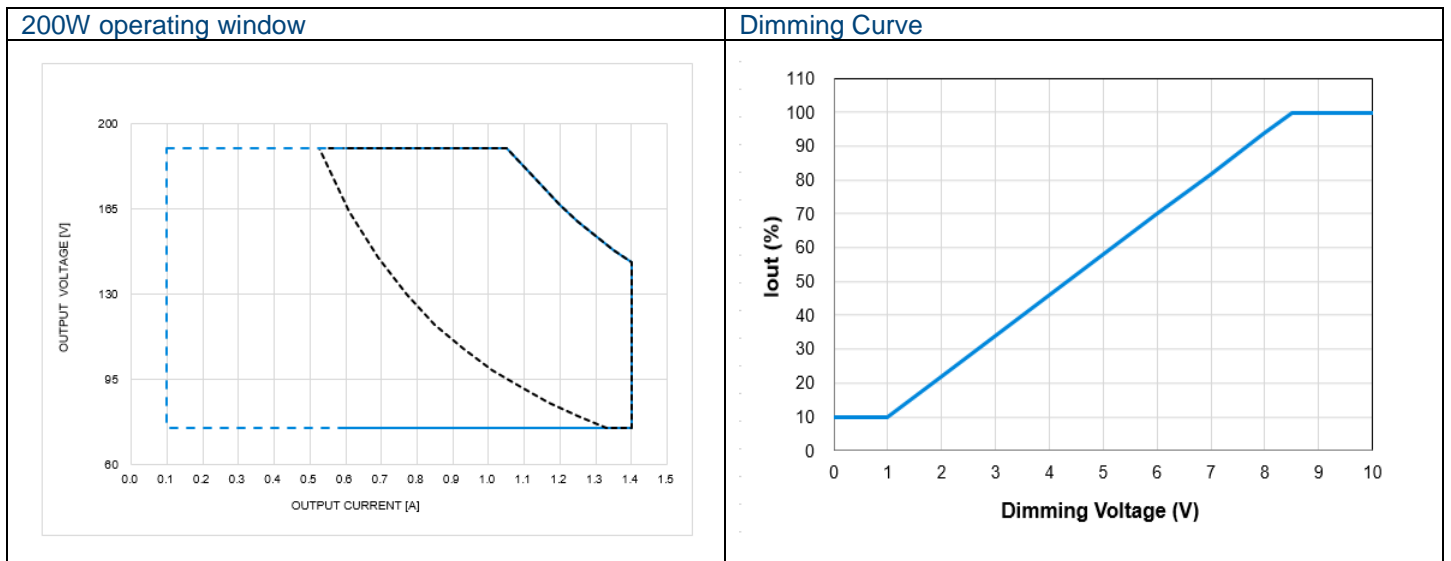
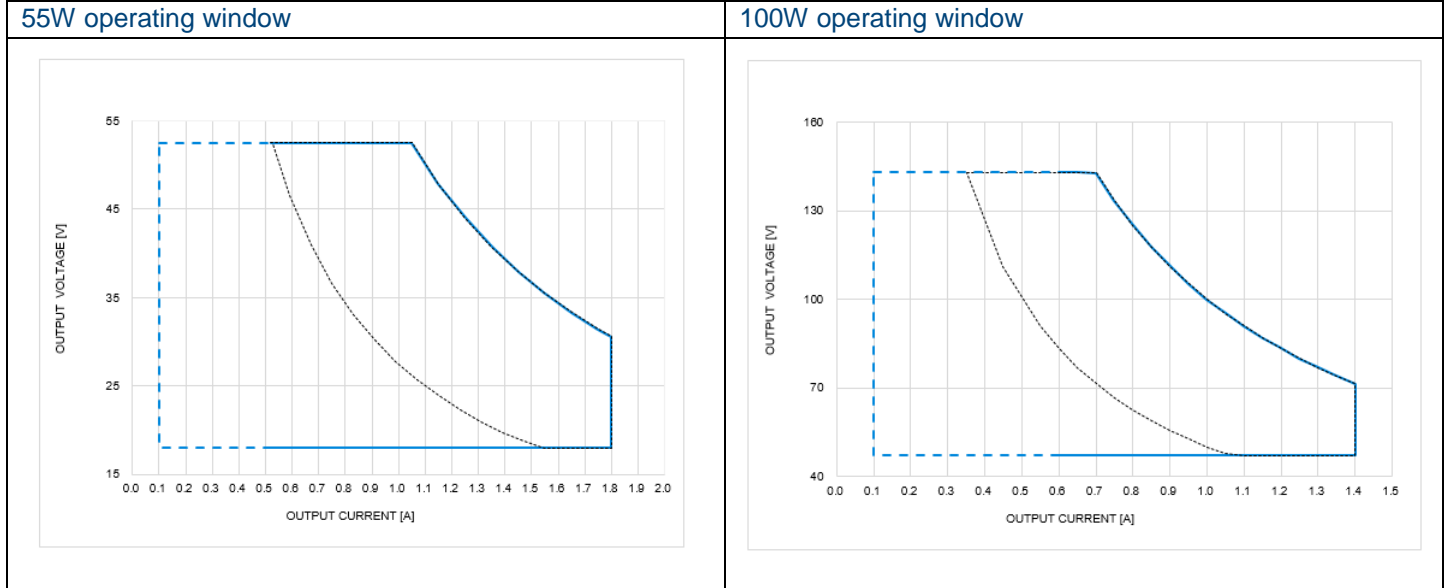

Note  
 Blue dot line for 0-10V range  
 Blue solid line for programming range  
 Black dot line for performance (PF>0.9V and THD<20%)

# LED Driver

## USCI LITE

### Efficiency VS Output Power

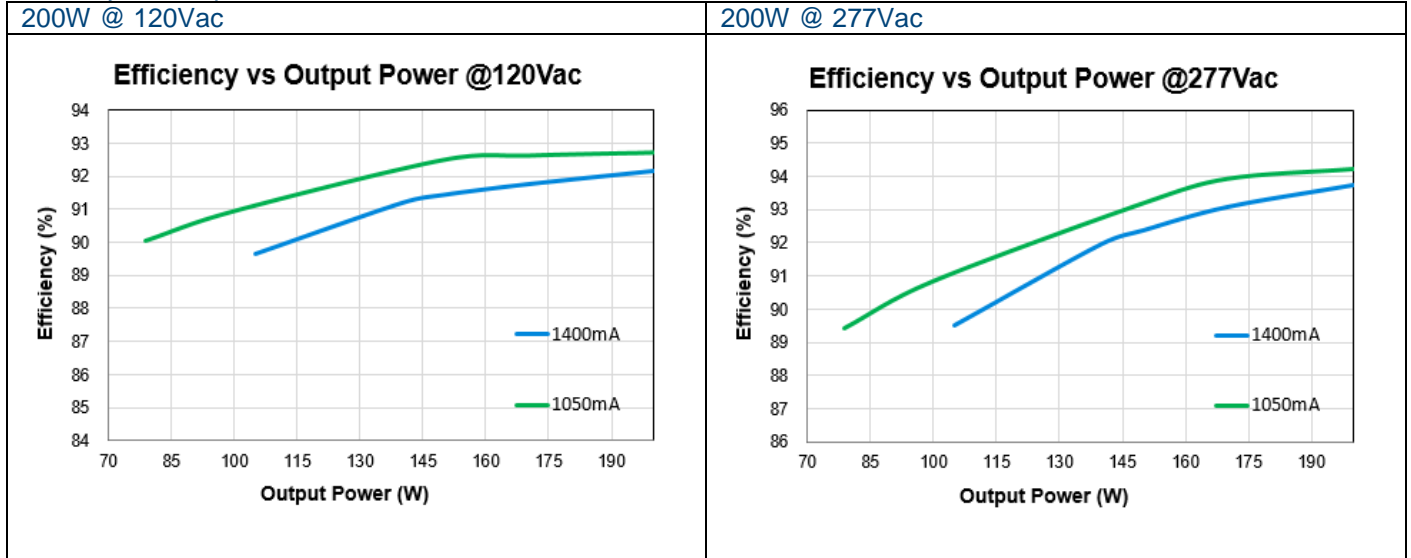

### Power Factor VS Output Power

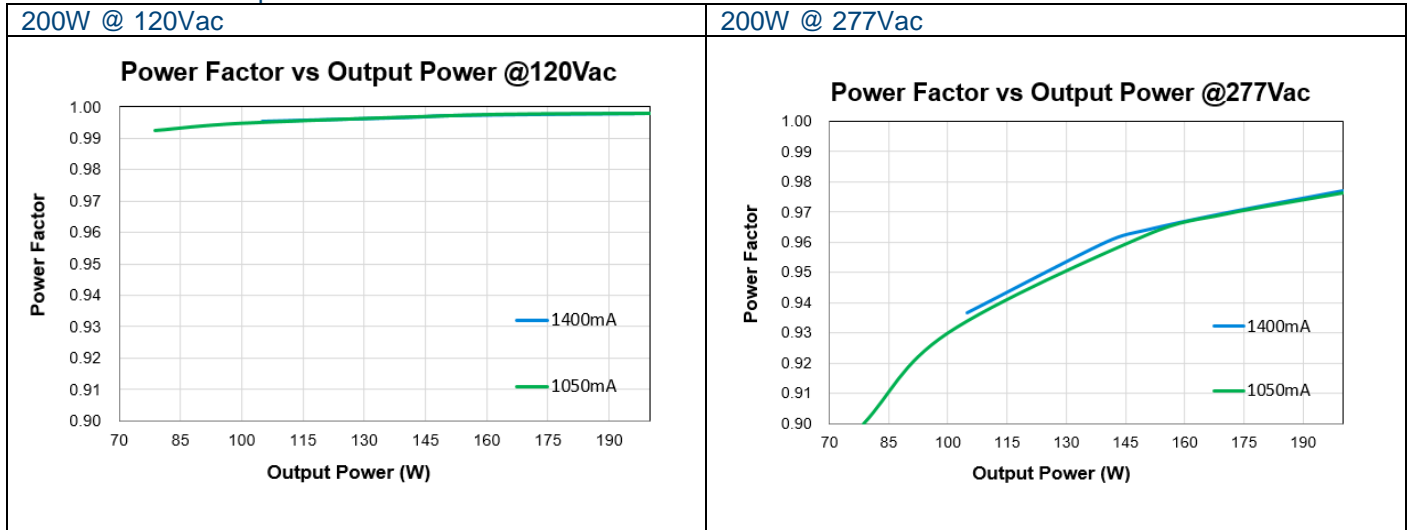

### Total Harmonic Distortion VS Output Power

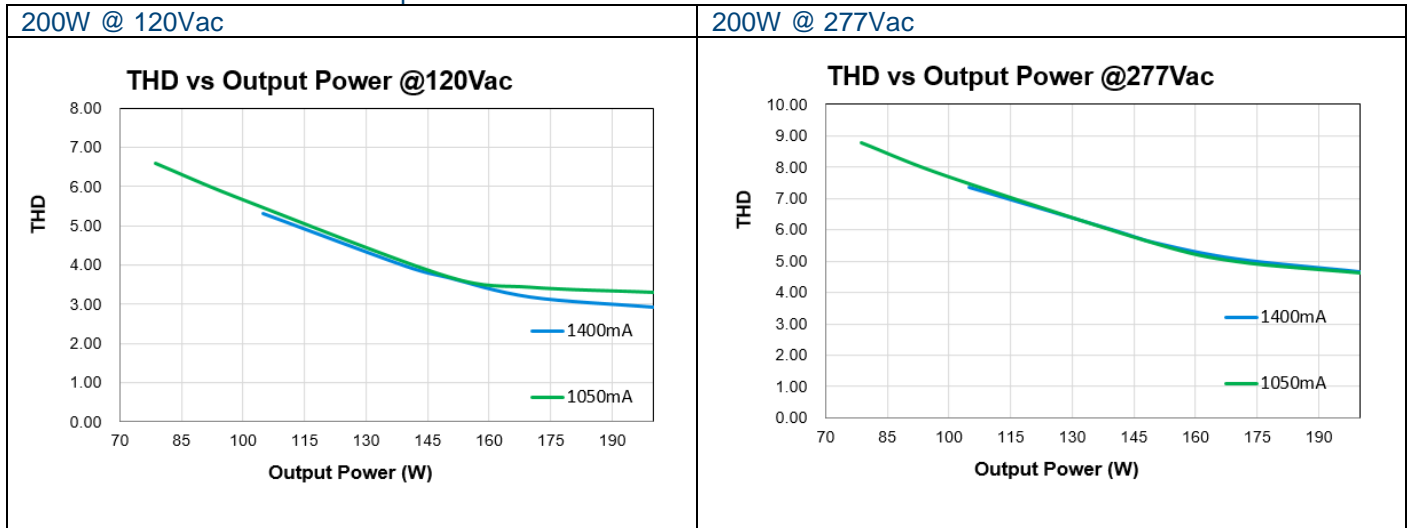



# LED Driver

## USCI LITE

### Efficiency VS Output Power

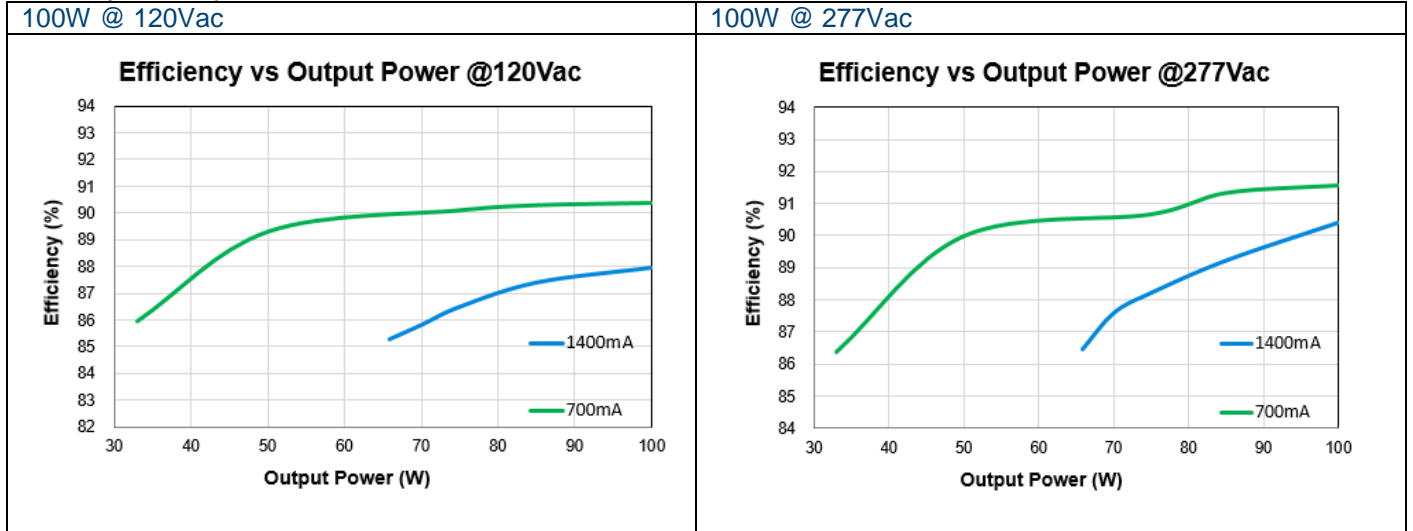

### Power Factor VS Output Power

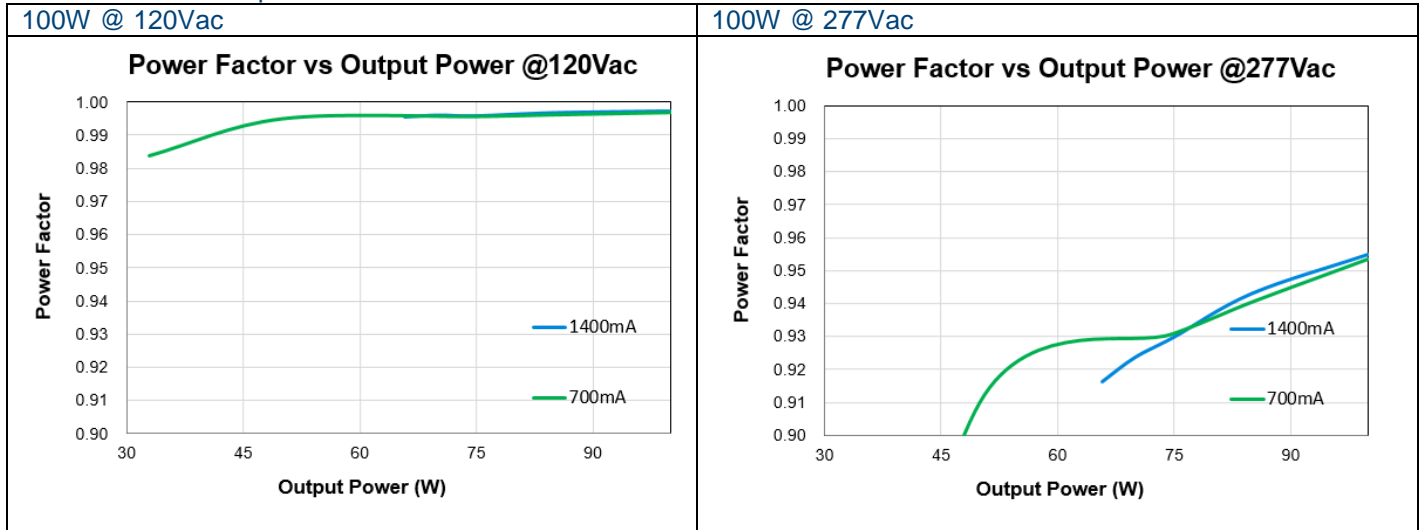

### Total Harmonic Distortion VS Output Power

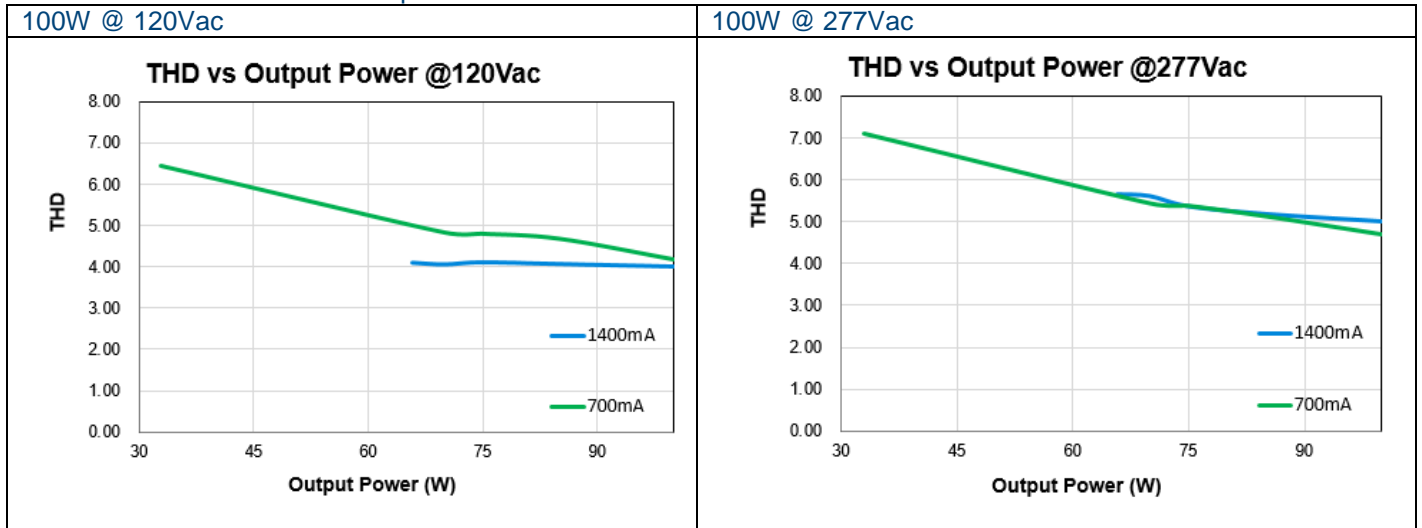

# LED Driver

## USCI LITE

### Efficiency VS Output Power

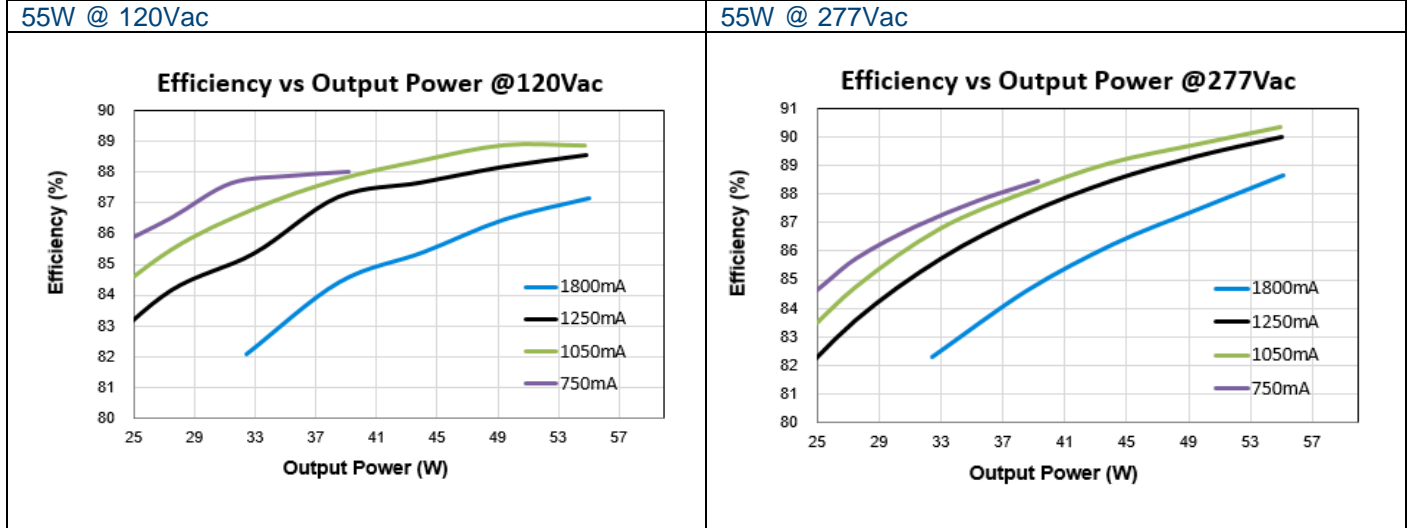

### Power Factor VS Output Power

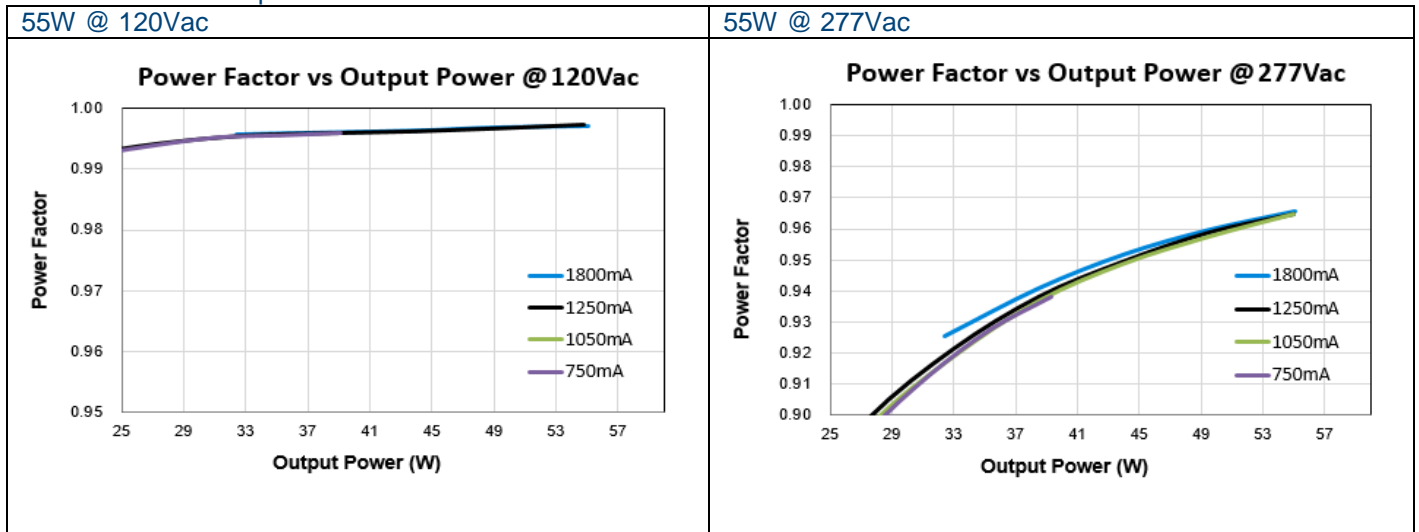

### Total Harmonic Distortion VS Output Power

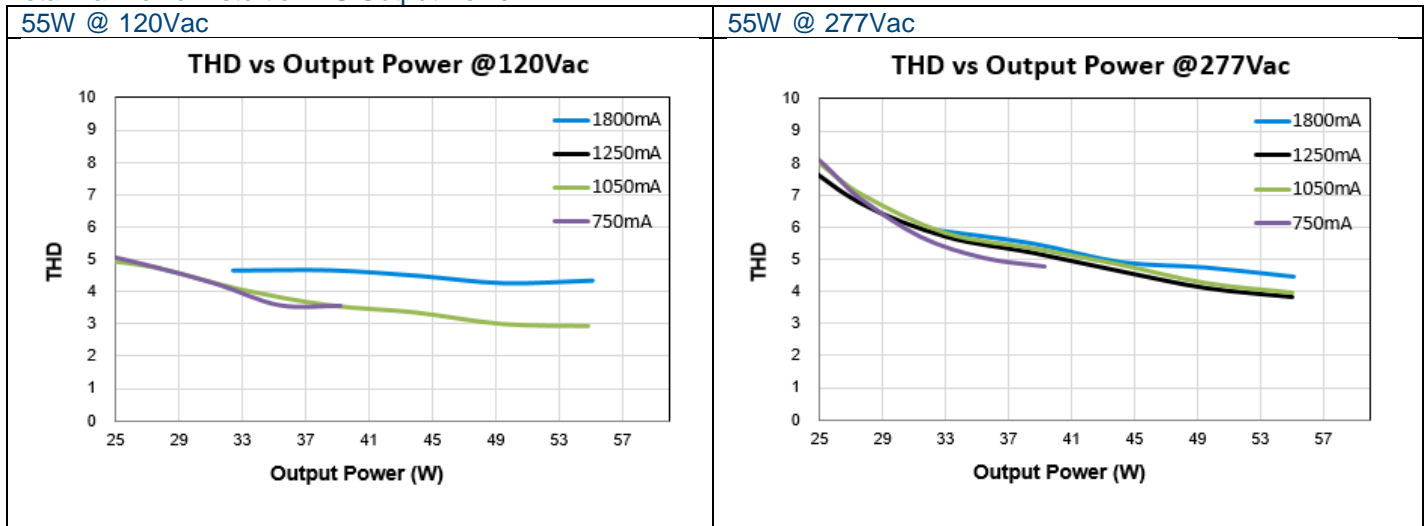

# LED Driver

## USCI LITE

### Lifetime VS Case Temperature

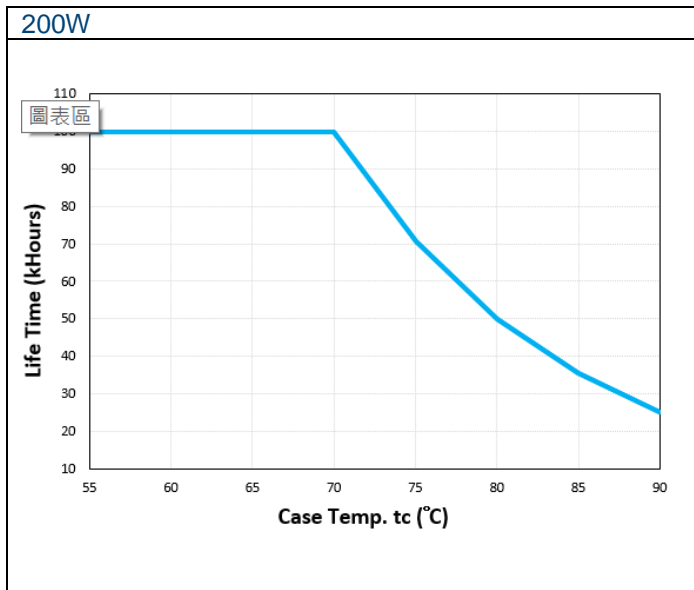
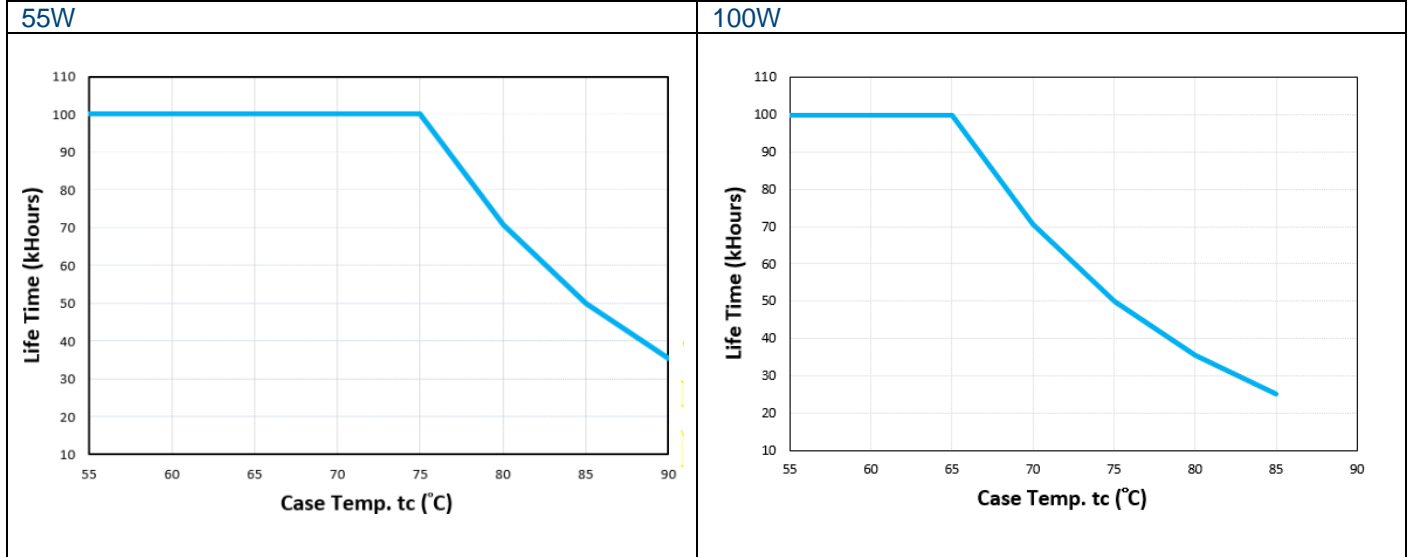

# LED Driver

## USCI LITE

### Enclosure Dimensions

	USCI-055180GB / USCI-100140GB	USCI-200140GB
	inch [mm]	inch [mm]
Total length (L1)	6.59 [167.5]	9.45 [240]
Case length (L2)	5.48 [139.2]	8.39 [213.2]
Case width (W)	2.36 [60.0]	2.36 [60.0]
Case height (H)	1.5 [37.5]	1.5 [37.5]
Mounting length (M1)	6.03 [153.2]	8.9 [226]
Mounting hole diameter (M2)	0.32 [8.0]	0.32 [8.0]

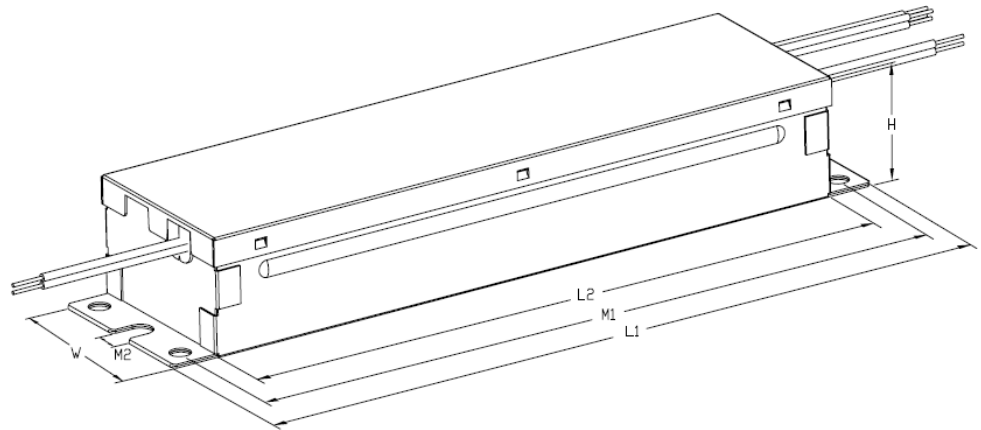

### Wiring Diagram

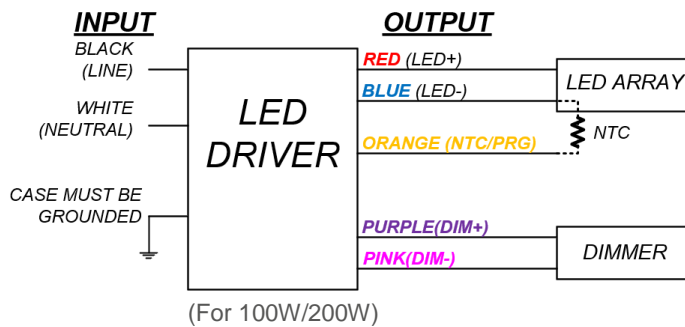
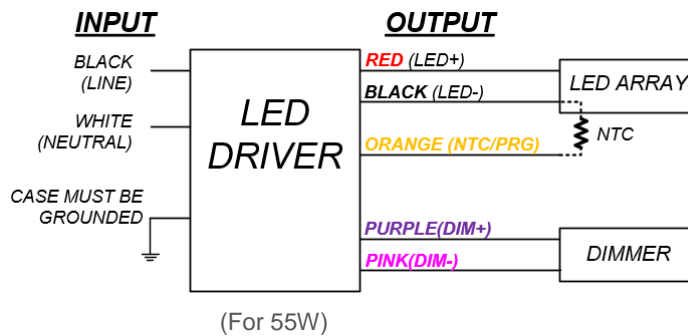

# LED Driver

## USCI LITE

### Assembly & Installation

The device is not recommended to be placed on low thermal conductive surfaces. For example, plastics.

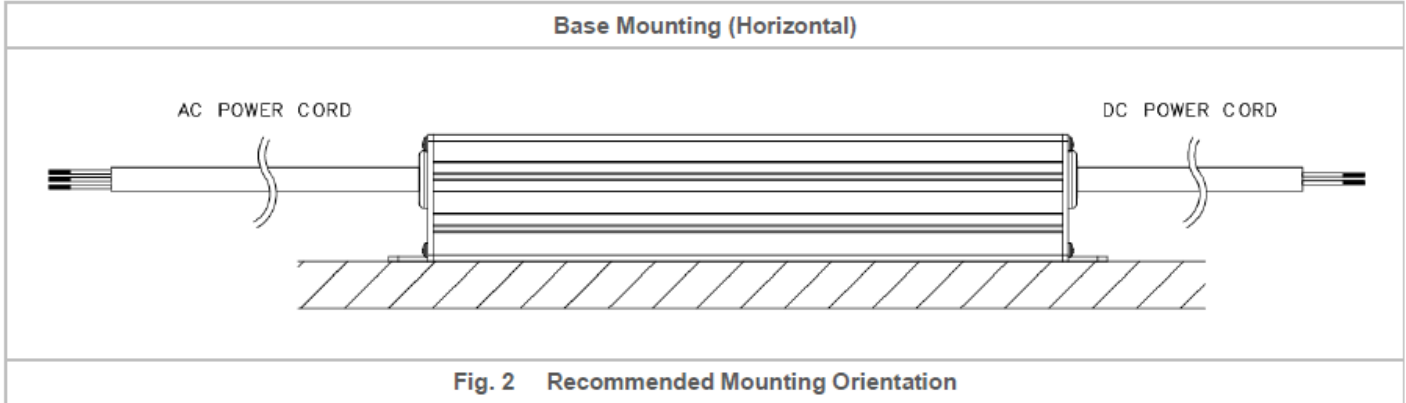

### Safety Instructions

- ALWAYS switch mains of input power OFF before connecting and disconnecting the input voltage to the device. If mains are not turned OFF, there is risk of explosion / severe damage.
- To guarantee sufficient convection cooling, keep a distance of 50mm above and lateral distance to other units.
- DO NOT insert any objects into the device.
- The case of LED driver must be connected with grounding (PE).
- The current rating for the output cable must be rated higher than or equal to the output current of the power supply. Please refer to the product specifications..

### Others

#### Warranty Policy

Please reach out our [Warranty Policy](#) should you require any further clarification.

## X-ON Electronics

Largest Supplier of Electrical and Electronic Components

*Click to view similar products for [LED Power Supplies](#) category:*

*Click to view products by [Delta](#) manufacturer:*

Other Similar products are found below :

[PIFC-K250F](#) [PITB-K222A](#) [ALD-514012PJ134](#) [LB240S24KH](#) [EUG-200S210DT](#) [ESS030W-1050-21](#) [BPOXL 4-12-035](#) [ESS010W-0180-42](#)  
[ESS010W-0350-24](#) [ESS010W-0200-42](#) [ESM060W-1400-42](#) [ESS010W-0500-12](#) [SLM140W-1.05-130-ZA](#) [ESS015W-0700-18](#) [HVG-320-](#)  
[36AB](#) [HVG-320-54AB](#) [DAL30W-0600-42-T](#) [HVG-320-48AB](#) [CNB50W-1200-42-CAS](#) [CNB30W-0600-42-CAS](#) [87500757](#) [I-SELECT 2](#)  
[PLUG 900MA BL](#) [LCU 48V 75W DC-STR FO](#) [I-SELECT 2 PLUG 200MA BL](#) [LC 45 W 500-1400 MA FLEXC SC EXC](#) [LC 50/200-](#)  
[350/170 FLEXCC LP SNC3](#) [LCO 14/100-500/38 O4A NF C EXC3](#) [LC 28W 300-700MA 42 FLEXC NF SC EXC3](#) [LC 44/1050/42 FIXC SRL](#)  
[ADV2](#) [LCA 60W 900-1750MA ONE4ALL C PRE](#) [LC 8/180/44 FIXC SR SNC2](#) [LC 19/200-350/54 FLEXC LP SNC4](#) [BXDR-PS-75BS-](#)  
[E116D-01-A](#) [LC 30/500/54 FIXC SR SNC2](#) [LCA 60W 24V ONE4ALL SC PRE SP](#) [LC 15/350/42 FIXC SRL ADV2](#) [LC 60W 75-330MA](#)  
[310V FLEXC NF H16 EXC4](#) [LC 10/350/29 FIXC SR SNC2](#) [LC 25/500/43 FIXC SR SNC2](#) [LC 50/100-400/140 PO4A NF H16 PRE3](#) [LC](#)  
[25/600/42 FIXC SRL ADV2](#) [LCO 24/200-1050/39 NF C ADV3](#) [ELEMENT 35/220...240/900 G3](#) [LC 25W 350-1050MA FLEXC SR EXC](#) [LC](#)  
[60/700/86 FIXC SR SNC2](#) [LC 35W 24 ONE4ALL IP PRE](#) [BXDR-PS-25BS-E107D-01-A](#) [LC 17W 250-700MA FLEXC SR EXC](#) [LC 15W](#)  
[350MA FIXC C SNC](#) [LC 14W 700MA FIXC PC SR SNC2](#)