

OLED DISPLAY MODULE

Product Specification

CUSTOMER	STANDARD	
PRODUCT NUMBER	DD-9664FC-2A	
CUSTOMER APPROVAL		

INTERNAL APPROVALS		
Product Mgr	Doc Control	Electr. Eng
Bruno Recaldini	Anthony Perkins	Bazile Peter
Date: 01/02/07	Date: 01/02/07	Date: 01/02/07

TABLE OF CONTENTS

1 MAIN FEATURES 4

2 MECHANICAL SPECIFICATION..... 5

2.1 MECHANICAL CHARACTERISTICS 5

2.2 MECHANICAL DRAWING 6

3 ELECTRICAL SPECIFICATION..... 7

3.1 ABSOLUTE MAXIMUM RATINGS 7

3.2 ELECTRICAL CHARACTERISTICS 8

3.3 INTERFACE PIN ASSIGNMENT 9

3.4 BLOCK DIAGRAM..... 11

3.5 TIMING CHARACTERISTICS 12

4 OPTICAL SPECIFICATION 15

4.1 OPTICAL CHARACTERISTICS..... 15

5 APPLICATION NOTES 16

6 SOFTWARE INITIAL SETTING 19

7 PACKAGING AND LABELLING SPECIFICATION..... 20

7.1 PACKAGING 20

7.2 LABELLING & MARKING..... 21

8 QUALITY ASSURANCE SPECIFICATION 22

8.1 CONFORMITY 22

8.2 DELIVERY ASSURANCE 22

8.3 DEALING WITH CUSTOMER COMPLAINTS 27

9 RELIABILITY SPECIFICATION 28

9.1 CONTENTS OF RELIABILITY TESTS 28

9.2 FAILURE CHECK STANDARD 28

9.3 LIFE TIME 28

10 HANDLING PRECAUTIONS..... 29

Product No.	DD-9664FC-2A	REV. A
		REV.

Page	2 / 29
------	--------

REVISION RECORD

Rev.	Date	Page	Chapt.	Comment	ECR no.
A	Feb 2007			Production Release	

Product No.	DD-9664FC-2A	REV. A
		REV.

Page	3 / 29
------	--------

1 MAIN FEATURES

ITEM	CONTENTS
Display Format	96 (R.G.B.) x 64 Dots
Overall Dimensions(W*H*T)	Glass 25.70 x 22.20 x 1.5 mm
Active Area(W*H)	20.14 x 13.42 mm
Viewing Area(W*H)	22.14 x 15.42 mm
Display Mode	Passive Matrix (0.95")
Display Colour	65,536 Colour
Driving Method	1 / 64 duty
Driver IC	SSD1331
Operating temperature	-30°C ~ +70°C
Storage temperature	-40°C ~ +80°C

Product No.	DD-9664FC-2A	REV. A
		REV.

Page	4 / 29
------	--------

2 MECHANICAL SPECIFICATION

2.1 MECHANICAL CHARACTERISTICS

ITEM	CHARACTERISTIC	UNIT
Display Format	96 (RGB x 64	Dots
Overall Dimensions	25.70 x 22.20 x 1.50	mm
Active Area(W*H)	20.14 x 13.42	mm
Viewing Area(W*H)	22.14 x 15.42	mm
Dot Size	0.05 x (RGB) x 0.19	mm
Dot Pitch	0.07 x (RGB) x 0.21	mm
Weight	1.8	g
IC Controller/Driver	SSD1331	

Product No.	DD-9664FC-2A	REV. A
		REV.

Page	5 / 29
------	--------

2.2 MECHANICAL DRAWING

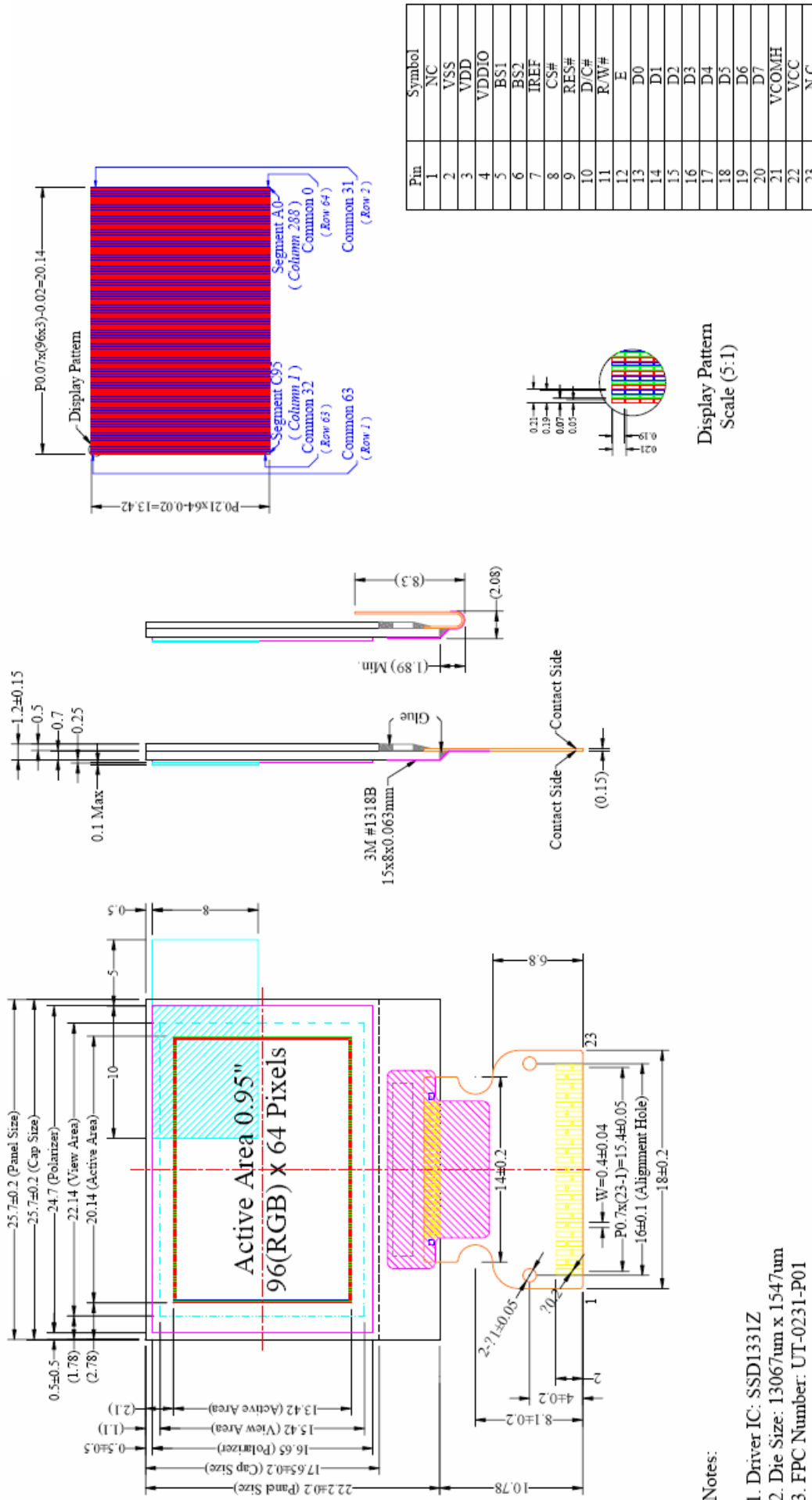

3 ELECTRICAL SPECIFICATION

3.1 ABSOLUTE MAXIMUM RATINGS

Item	Symbol	Min	Max	Unit	Note
Supply Voltage	V _{DD}	-0.3	4	V	Note 1,2
Driver Supply Voltage	V _{CC}	0	15	V	
V _{CC} Supply Current	I _{CC}	-	25	mA	
Operating Temperature	T _{op}	-30	70	°C	-
Storage Temperature	T _{st}	-40	80	°C	-
Static Electricity	Be sure that you are grounded when handling displays.				

Note 1: All the above voltages are on the basis of “GND=0V”.

Note 2: When this module is used beyond the above absolute maximum ratings, permanent breakage of the module may occur. Also, for normal operations, it's desirable to use this module under the conditions according to Section 3 “Electrical Characteristics”.

Product No.	DD-9664FC-2A	REV. A
		REV.

Page	7 / 29
------	--------

3.2 ELECTRICAL CHARACTERISTICS

3.2.1 DC CHARACTERISTICS

Characteristics	Symbol	Conditions	Min	Typ	Max	Unit
Supply Logic	V _{DD}		2.4	2.8	3.5	V
Supply Voltage for I/O pins	V _{DDIO}		1.6	2.8	3.5	V
Driver Supply Voltage	V _{CC}		-	14.0	-	V
Operating Current for V _{DD}	I _{DD}	Note 1	-	0.2	0.6	mA
		Note 2	-	0.2	0.6	mA
Operating Current for V _{CC}	I _{CC}	Note 1	-	8	11	mA
		Note 2	-	13.5	18	mA
Sleep Mode Current for V _{DD}	I _{DD sleep}		-	1	2	μA
Sleep Mode Current for V _{CC}	I _{CC sleep}		-	<2	2	μA
High Level Input	V _{IH}	I _{out} = 100μA, 3.3MHz	0.8xV _{DD}	-	V _{DDIO}	V
Low Level Input	V _{IL}		0	-	0.2xV _{DDIO}	V
High Level Output	V _{OH}		0.9xV _{DDIO}	-	V _{DDIO}	V
Low Level Output	V _{OL}		0	-	0.1xV _{DDIO}	V

Note 1: V_{DD} = 2.8V, V_{CC} = 14V, Software Initial Setting follow Section. 6 “Software initial setting”, 50% Display area turn on.

Note 2: V_{DD} = 2.8V, V_{CC} = 14V, Software Initial Setting follow Section. 6 “Software initial setting”, 100% Display area turn on.

Product No.	DD-9664FC-2A	REV. A
		REV.

Page	8 / 29
------	--------

3.3 INTERFACE PIN ASSIGNMENT

No.	Symbol	I/O	Function											
1	N.C.	-	Reserved Pin (Supporting Pin). The supporting pins can reduce the influences from stresses on the function pins.											
2	VSS	P	Ground of System. This is a ground pin. It also acts as a reference for the logic pins, the OLED driving voltages and the analog circuits. It must be connected to external ground.											
3	VDD	P	Power Supply for Interface Logic Level. This is a voltage supply pin. It must be connected to external source.											
4.	VDDIO	P	Power Supply for Interface Logic Level. It Should match with the MCU interface voltage level. VDDIO must always be equal or lower than VDD											
5	BS1	I	Communicating Protocol Select. These pins are MCU interface selection input. See the following table:											
6	BS2													
				<table border="1"> <thead> <tr> <th></th> <th>68XX-parallel</th> <th>80XX-parallel</th> <th>Serial</th> </tr> </thead> <tbody> <tr> <td>BS1</td> <td>0</td> <td>1</td> <td>0</td> </tr> <tr> <td>BS2</td> <td>1</td> <td>1</td> <td>0</td> </tr> </tbody> </table>		68XX-parallel	80XX-parallel	Serial	BS1	0	1	0	BS2	1
	68XX-parallel	80XX-parallel	Serial											
BS1	0	1	0											
BS2	1	1	0											
7	IREF	I	Current Reference for Brightness Adjustment. This pin is segment current reference pin. A resistor should be connected between this pin and VSS. Set the current at 10uA.											
8	CS#	I	Chip Select. This pin is the chip select input. The chip is enabled for MCU communication only when CS# is pulled low.											
9	RES#	I	Power Reset for Controller and Driver. This pin is reset signal input. When the pin is low, initialization of the chip executed.											
10	D/C#	I	Data/Command Control. This pin is Data/Command control pin. When the pin is pulled high, the input at D7~D0 is treated as display data. When the pin is pulled low, the input at D7~D0 will be transferred to the command register. For detail relationship to MCU interface signal, please refer to the Timing Characteristics Diagrams.											
11	R/W#(WR#)	I	Read/Write Select or Write. This pin is MCU interface input. When interface to a 68XX-series microprocessor, this pin will be used as the Read/Write (R/W#) selection input. Pull this pin to “High” for read mode and pull it to “Low” for write mode. When 80XX interface mode is selected this pin will be the Write (WR#) input. Data write operation is initiated when this pin is pulled low and the CS# is pulled low.											
12	E(RD#)	I	Read/ Write Enable or Read. This pin is MCU interface input. When interfacing to a 68XX-series microprocessor this pin will be used as the Enable (E) signal. Read/Write operation is initiated when this pin is pulled high and the CS# is pulled low. When connecting to an 80XX-microprocessor, this pin receives the Read (RD#) signal. Data read operation is initiated when this pin is pulled low and CS# is pulled low.											
13~20	D0~D7	I/O	Host Data Input / Output Bus These pins are 8 bit bi-directional data bus to be connected to											

Product No.	DD-9664FC-2A	REV. A
		REV.

Page	9 / 29
------	--------

			the microprocessor's data bus. When serial mode is selected, D1 will be the serial data input SDIN and D0 will be the serial clock input SCLK.
21	VCOMH	O	Voltage Output High Level for COM Signal. The COM signal deselected voltage level. A tantalum capacitor should be connected between this pin and VSS
22	VCC	P	Power Supply for OLED panel. This is the most positive voltage supply pin of the chip. It should be supplied externally.
23	N.C.	-	Reserved Pin (Supporting Pin). The supporting pins can reduce the influences from stresses on the function pins.

Product No.	DD-9664FC-2A	REV. A
		REV.

Page	10 / 29
------	---------

3.4 BLOCK DIAGRAM

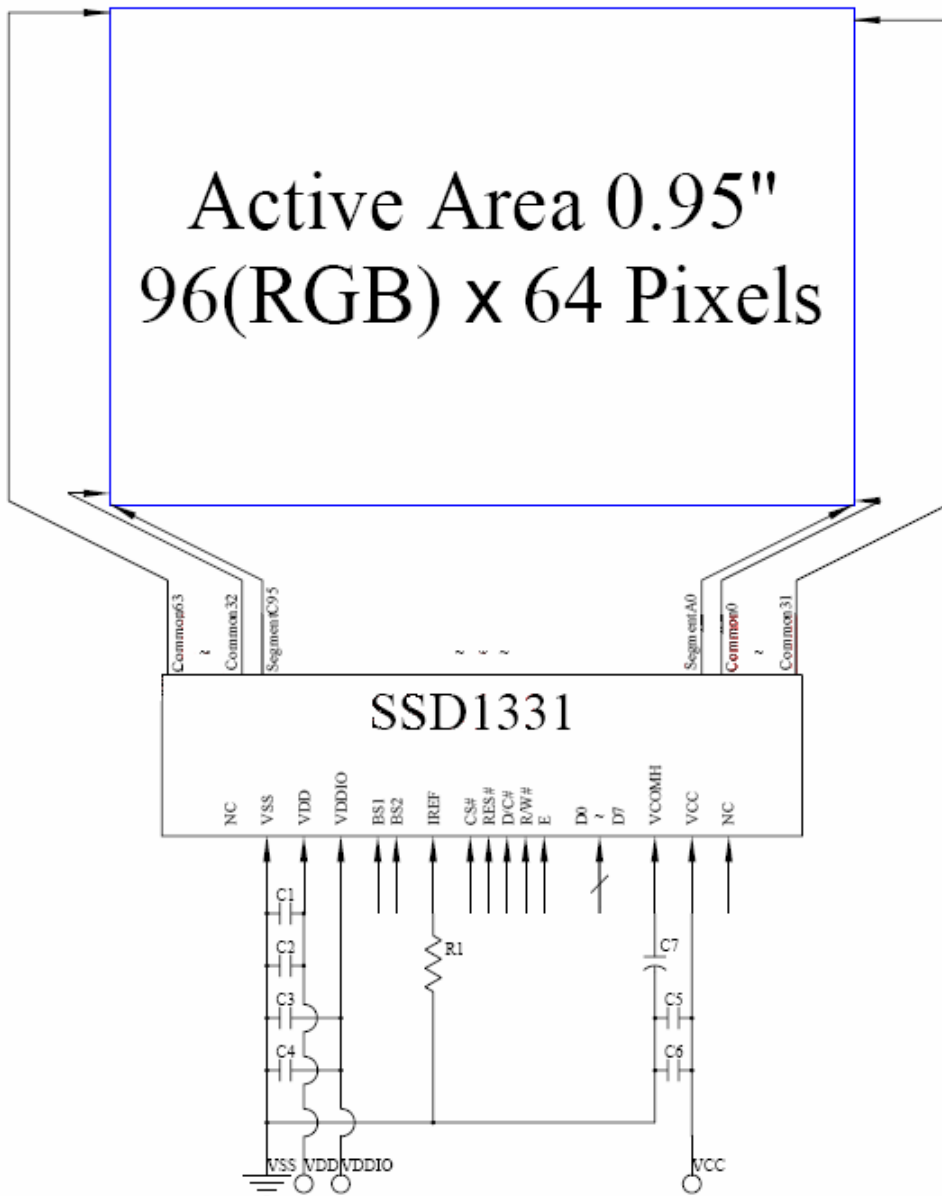

MCU Interface Selection: BS1 and BS2

Pins connected to MCU interface : D7~D0, E/RD#, R/W#, CS#, D/C# and RES#

C1, C3, C5 : 10µF

C2, C4, C6 : 0.1 µF

C7 : 4.7 µF/20V Tantalum CAP

R1 : 1.2M, $R1 = (\text{Voltage at IREF} - \text{VSS}) / \text{IREF}$

Product No.	DD-9664FC-2A	REV. A
		REV.

Page	11 / 29
------	---------

3.5 TIMING CHARACTERISTICS

3.5.1 AC CHARACTERISTICS

3.5.1.1 68XX-Series MPU Parallel Interface Timing Characteristics:

Characteristics	Symbol	Min	Max	Unit
Clock Cycle Time (write cycle)	t_{cycle}	130	-	ns
Control Pulse Low Width (write cycle)	PW _{CSL}	60	-	ns
Control Pulse High Width (write cycle)	PW _{CSH}	60	-	ns
Clock Cycle Time (read cycle)	t_{cycle}	200	-	ns
Control Pulse Low Width (read cycle)	PW _{CSL}	100	-	ns
Control Pulse High Width (read cycle)	PW _{CSH}	100	-	ns
Address Setup Time	t_{AS}	0	-	ns
Address Hold Time	t_{AH}	10	-	ns
Data Setup Time	t_{DSW}	40	-	ns
Data Hold Time	t_{DHW}	10	-	ns
Access Time	t_{ACC}	-	140	ns
Output Disable Time	t_{ACC}	-	70	ns
Rise Time	t_R	-	15	ns
Fall Time	t_F	-	15	ns

*($V_{DD} - V_{SS} = 2.4V$ to $3.5V$, $V_{DDIO} = 2.4V$ to V_{DD} , $T_a = -40$ to $+85^\circ C$)

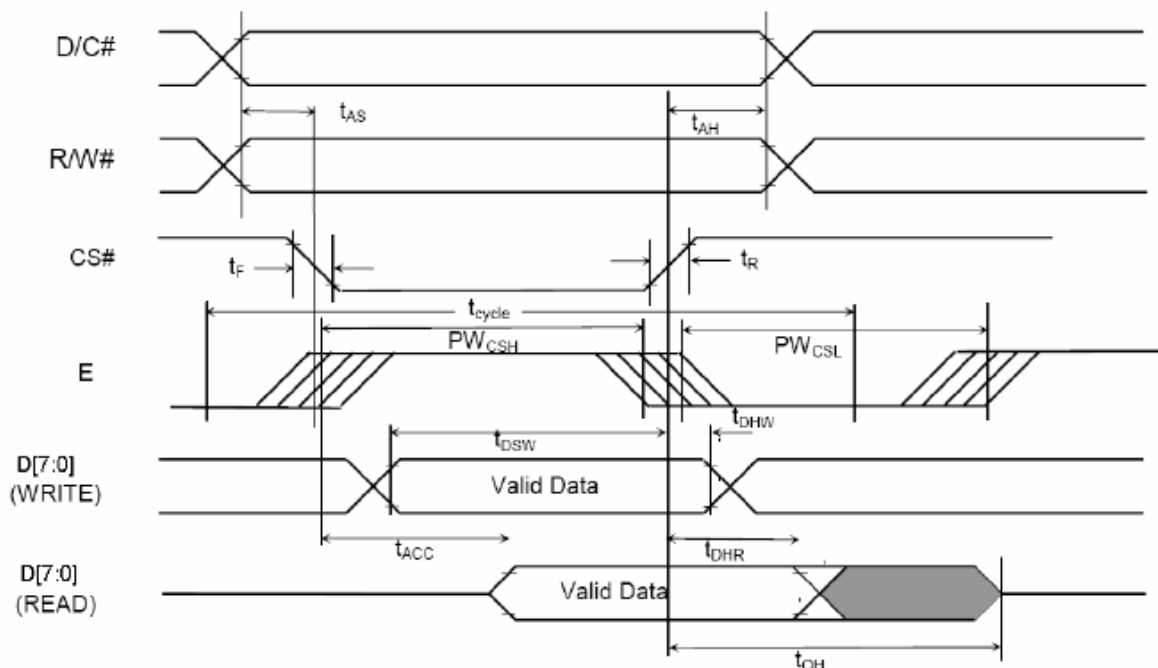

Product No.	DD-9664FC-2A	REV. A
		REV.

Page	12 / 29
------	---------

3.5.1.2 8080-Series MPU Parallel Interface
Timing Characteristics:

Characteristics	Symbol	Min	Max	Unit
Clock Cycle Time	t_{cycle}	130	-	ns
Address Setup Time	t_{AS}	0	-	ns
Address Hold Time	t_{AH}	10	-	ns
Write Data Setup Time	t_{DSW}	40	-	ns
Write Data Hold Time	t_{DHW}	15	-	ns
Read Data Hold Time	t_{DHR}	20	-	ns
Output Disable Time	t_{OH}	-	70	ns
Access Time	t_{ACC}	-	140	ns
Chip Select Low Pulse Width (Read) Chip Select Low Pulse Width (Write)	PW_{CSL}	120 60	-	ns
Chip Select High Pulse Width (Read) Chip Select High Pulse Width (Write)	PW_{CSH}	60 60	-	ns
Rise Time	t_R	-	15	ns
Fall Time	t_F	-	15	ns

*** ($V_{DD} - V_{SS}$ 2.4V to 3.5V, $V_{DDIO} = 2.4V$ to V_{DD} , $T_a = -40$ to $+85^\circ C$)**

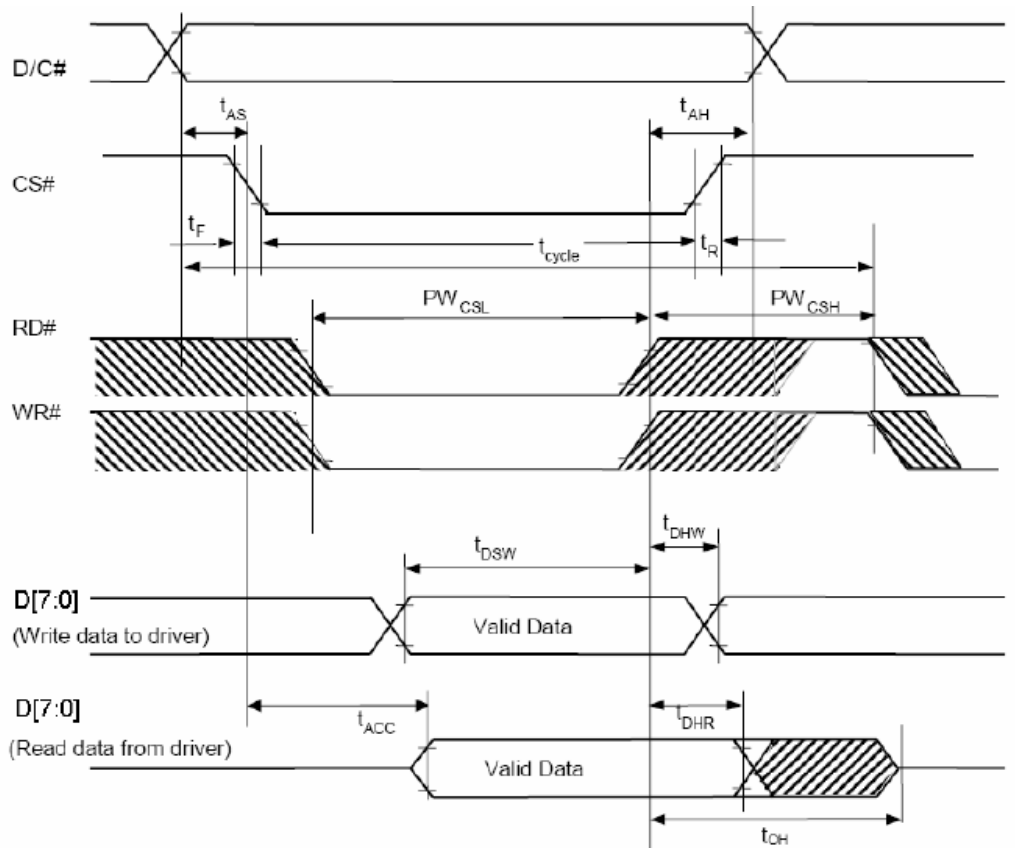

Product No.	DD-9664FC-2A	REV. A
		REV.

Page	13 / 29
------	---------

3.5.1.3 Serial Interface Timing Characteristics:

Characteristics	Symbol	Min	Max	Unit
Clock Cycle Time	t_{cycle}	150	-	ns
Address Setup Time	t_{AS}	40	-	ns
Address Hold Time	t_{AH}	40	-	ns
Chip Select Setup Time	t_{CSS}	75	-	ns
Chip Select Hold Time	t_{CSH}	60	-	ns
Write Data Setup Time	t_{DSW}	40	-	ns
Write Data Hold Time	t_{DHW}	40	-	ns
Clock Low Time	t_{CLKL}	75	-	ns
Clock High Time	t_{CLKH}	75	-	ns
Rise Time	t_R	-	15	ns
Fall Time	t_F	-	15	ns

*** ($V_{DD} - V_{SS} = 2.4V$ to $3.5V$, $V_{DDIO} = 2.4V$ to V_{DD} , $T_a = -40$ to $+85^{\circ}C$)**

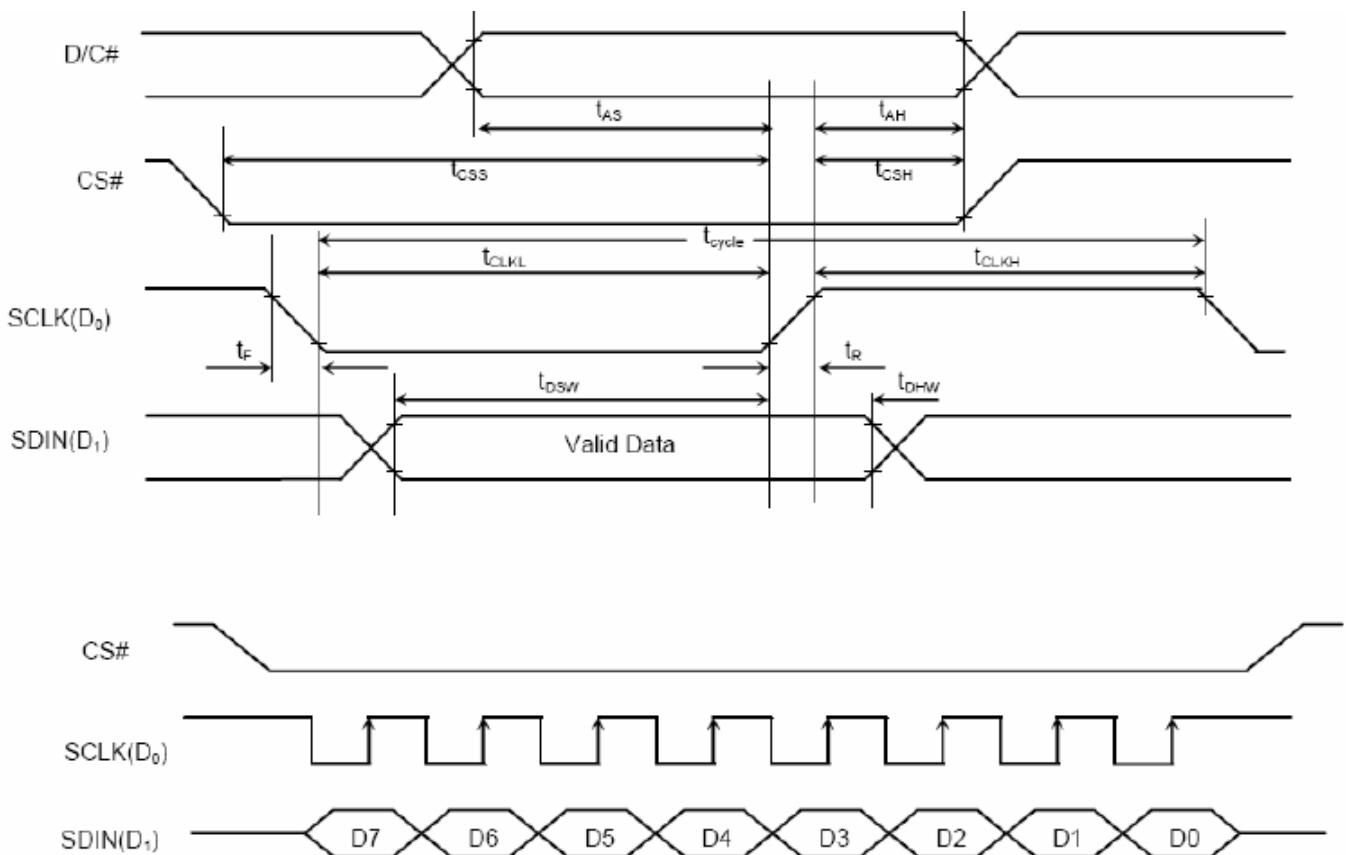

4 OPTICAL SPECIFICATION

4.1 OPTICAL CHARACTERISTICS

Characteristics	Symbol	Condition	Min	Typ	Max	Unit
Brightness(White)	L _{br}	With Polarizer Note 1	80	100	-	cd/m ²
C.I.E.(White)	(X)	With Polarizer	0.26	0.30	0.34	-
	(Y)		0.29	0.33	0.37	
C.I.E.(Red)	(X)	With Polarizer	0.60	0.64	0.68	-
	(Y)		0.30	0.34	0.38	
C.I.E.(Green)	(X)	With Polarizer	0.28	0.32	0.36	-
	(Y)		0.58	0.62	0.66	
C.I.E.(Blue)	(X)	With Polarizer	0.11	0.15	0.19	-
	(Y)		0.16	0.20	0.24	
Frame Rate			-	100	-	F/sec
Dark Room Contrast	CR	Shown as below	-	>1:1000	-	-
View Angle			>160	-	-	degree

Optical measurement taken at VDD = 2.8V, VCC = 14V and software configuration follows Section 6 “Software Initial Setting”

Note 1: Brightness (Lbr) and Driver Supply Voltage (Vcc) are subject to the change of the panel characteristics and the customer’s request.

Product No.	DD-9664FC-2A	REV. A
		REV.

Page	15 / 29
------	---------

5 APPLICATION NOTES

5.1 COMMANDS

Please refer to the Technical Manual for the SSD1331.

5.2 POWER UP/DOWN SEQUENCE

To protect panel and extend the panel life time, the driver IC power up/down routine should include a delay period between high voltage and low voltage power sources during turn on/off. It gives the panel enough time to complete the action of charge and discharge before/after the operation.

5.2.1 POWER UP SEQUENCE :

1. Power up V_{DD} & V_{DDIO}
2. Send Display off command
3. Clear Screen
4. Power up V_{CC}
5. Delay 100ms
(When V_{DD} & V_{DDIO} is stable)
6. Send Display on command

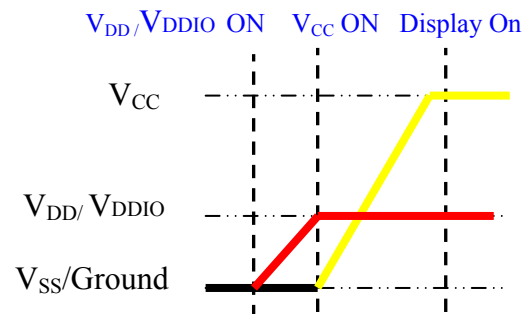

5.2.2 POWER DOWN SEQUENCE :

1. Send Display off command
2. Power down V_{CC}
3. Delay 100ms
(when V_{CC} is reach 0 and panel is completely discharges)
4. Power down V_{DD} & V_{DDIO}

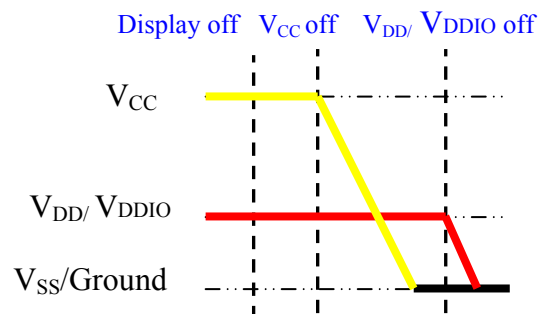

5.3 RESET CIRCUIT

When RES# input is low, the chip is initialized with the following status:

1. Display is off
2. 64MUX Display Mode
3. Display start line is set at display RAM address 0
4. Display offset set to 0
5. Normal segment and display data column address and row address mapping (SEG0 mapped to address 00H and COM0 mapped to address 00H)
6. Column address counter is set at 0
7. Master contrast control register is set at 0FH
8. Individual contrast control registers of colour A, B and C are set at 80H.
9. Shift register data clear in serial interface
10. Normal display mode (Equivalent to A4 command)

Product No.	DD-9664FC-2A	REV. A
		REV.

Page	16 / 29
------	---------

5.4 APPLICATION EXAMPLE

Command usage and explanation of an actual example

< Initialization Setting >

Set Display On/Off (1010111X)

10101110=>0xAE (Display Off)

Set Display Mode (101001XX)

10100100=>0xA4 (Normal Display Mode)

Set Display Clock Divide Ratio / Oscillator Frequency

(10110011 with XXXXXXXX)

Set Display Offset

(10100010 with XXXXXXXX)

Set Multiplex Ratio

(11001000 with XXXXXXXX)

Set Master Configuration

(10101101 with 1000111X)

10001110=>0x8E (External VCC supply selected)

Set Display Start Line

(10100001 with XXXXXXXX)

Set Segment Re-map & Data Format

(10100000 with XXXXXXXX)

Set Master Current Control

(10000111 with ****XXXX)

Set Contrast Control for Colour "A"

(10000001 with XXXXXXXX)

Set Contrast Control for Colour "B"

(10000010 with XXXXXXXX)

Set Contrast Control for Colour "C"

(10000011 with XXXXXXXX)

Set Pre-charge Level

(10111011 with **XXXXXX)

Set Second Pre-charge speed of colour A

(10001010 with XXXXXXXX)

Set Second Pre-charge speed of Colour B

(10001011 with XXXXXXXX)

Set Second Pre-charge speed of Colour C

(10001100 with XXXXXXXX)

Set VCOMH

(10111110 with 00XXXXX0)

Set Phase 1 & 2 Period Adjustment

(10110001 with XXXXXXXX)

Product No.	DD-9664FC-2A	REV. A
		REV.

Page	17 / 29
------	---------

Set Power Saving Mode
(10110000 with 000XXXXX)

Set Display On/Off (1010111X)
10101111=> 0xAF (Display On)

<Display Boundary Settings>

Set Colum Address

(00010101 with XXXXXXXX for Start & XXXXXXXX for End)

Set Row Address

(01110101 with XXXXXXXX for Start & XXXXXXXX for End)

If the noise is accidentally occurred at the displaying window during the operation, please reset the display in order to recover the display function.

Product No.	DD-9664FC-2A	REV. A
		REV.

Page	18 / 29
------	---------

6 SOFTWARE INITIAL SETTING

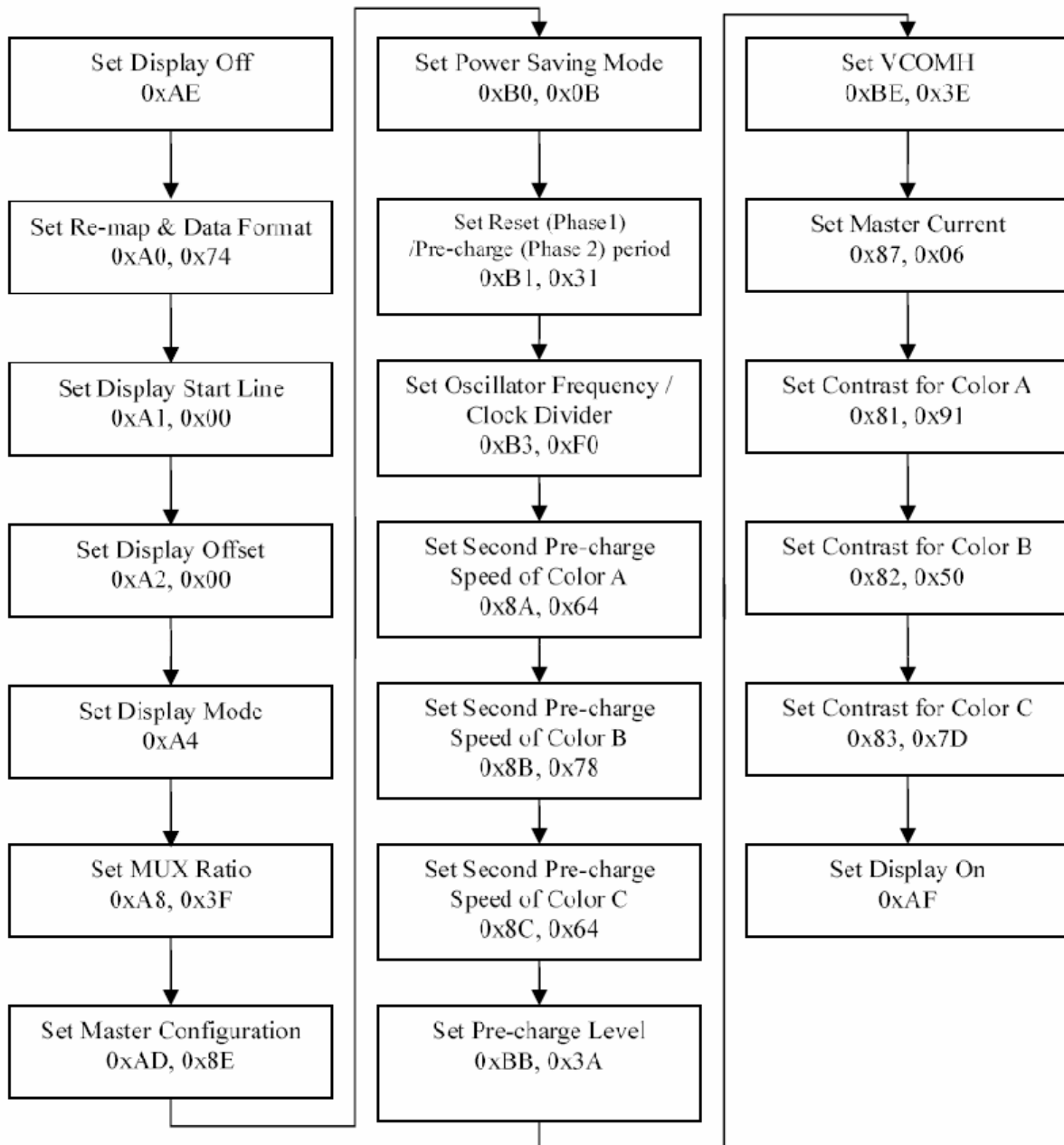

Product No.	DD-9664FC-2A	REV. A
		REV.

Page	19 / 29
------	---------

7 PACKAGING AND LABELLING SPECIFICATION

7.1 PACKAGING

7.1.1 Material

	Item	Part code	Dimensions (mm)	Unit weight (kg)	Quantity
1	Module	DD-9664FC-2A	25.7*22.1*1.5	0.002	2520
2	Tray	*****	***	0.010	
3	Inner box	*****	***	0.250	4
4	Carton	*****	***	1.100	1
5	Inner box bag	*****	***	***	***
6	Total weight	7.54 Kg		± 5%	

7.1.2 Specification and quantity

Modules x tray	Quantity per row	6	x	Quantity per column	7	=	42
Modules per box	Quantity per tray	42	x	Quantity of trays	15	=	630
Total no. of modules	Quantity per box	630	x	Quantity of boxes	4	=	2520

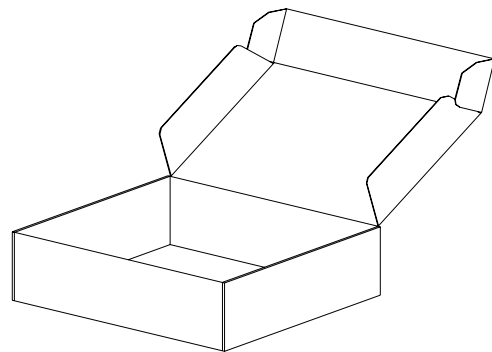
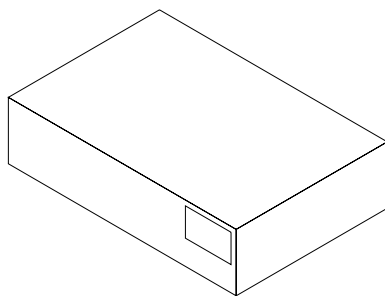
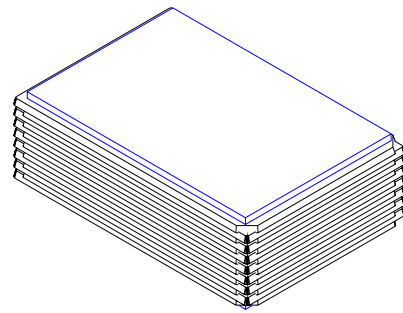
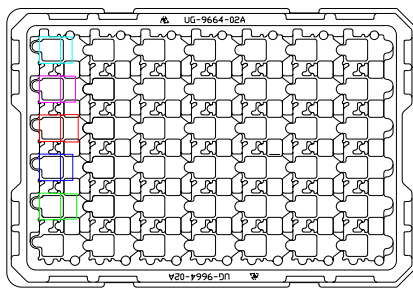

Product No.	DD-9664FC-2A	REV. A
		REV.

Page	20 / 29
------	---------

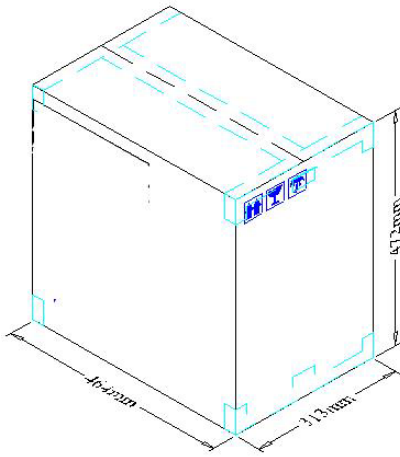
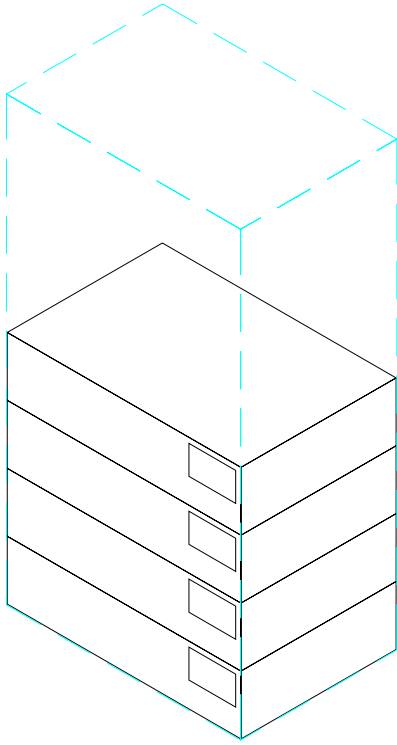

7.2 LABELLING & MARKING

DENSITRON
DD-9664FC-2A
TW YY MM

Product No.	DD-9664FC-2A	REV. A
		REV.

Page	21 / 29
------	---------

8 QUALITY ASSURANCE SPECIFICATION

8.1 CONFORMITY

The performance, function and reliability of the shipped products conform to the Product Specification.

8.2 DELIVERY ASSURANCE

8.2.1 Delivery inspection standards

- IPC-AA610 rev. C, class 2 electronic assemblies standard

8.2.2 Zone definition

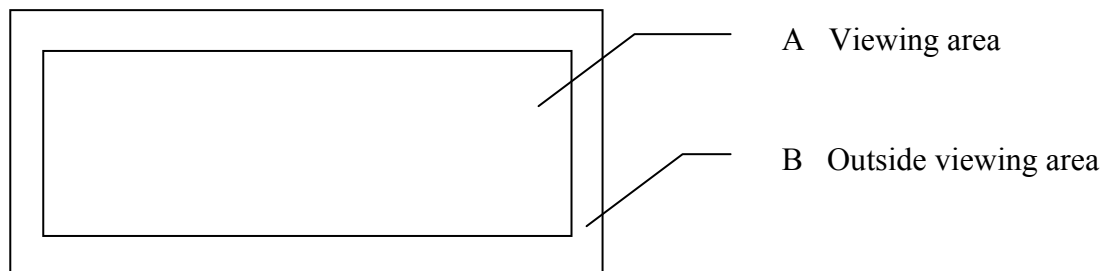

Product No.	DD-9664FC-2A	REV. A
		REV.

Page	22 / 29
------	---------

8.2.3 Visual inspection

- Inspect under 30W fluorescent lamp leaving 50 cm between the module and the lamp and 30 cm between the module and the eye (measuring position).
- Appearance is inspected at the best contrast voltage (best contrast is adjusted considering clearness and crosstalk on screen).
- Inspect the module at 45° right and left, top and bottom.
- Use the optimum viewing angle during the contrast inspection.

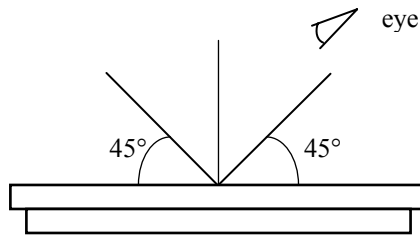

Product No.	DD-9664FC-2A	REV. A
		REV.

Page	23 / 29
------	---------

8.2.4 Standard of appearance inspection

Units: mm

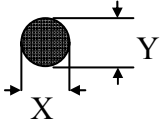
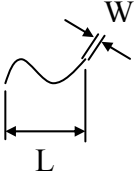
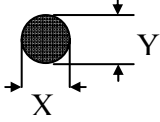
Class	Item	Criteria																																	
Minor	Packing & Label	Outside & inside package Presence of product no., lot no., quantity																																	
Critical		Product must not be mixed with others and quantity must not be different from that indicated on the label																																	
Major	Dimension	Product dimensions must be according to specification and drawing																																	
Major	Electrical	Product electrical characteristics must be according to specification																																	
Critical	OLED Display	Missing lines or wrong patterns on display are not allowed																																	
Minor	Black spot, white spot, dust	<p>Round type: as per following drawing $\varnothing = (X+Y)/2$</p>  <table border="1" style="margin-left: auto; margin-right: auto;"> <thead> <tr> <th colspan="3">Acceptable quantity</th> </tr> <tr> <th>Size</th> <th>Zone A</th> <th>Zone B</th> </tr> </thead> <tbody> <tr> <td>$\varnothing < 0.1$</td> <td>Any number</td> <td rowspan="4">Any number</td> </tr> <tr> <td>$0.1 < \varnothing < 0.2$</td> <td>3</td> </tr> <tr> <td>$0.2 < \varnothing < 0.25$</td> <td>1</td> </tr> <tr> <td>$0.25 < \varnothing$</td> <td>0</td> </tr> </tbody> </table> <p>Line type: as per following drawing</p>  <table border="1" style="margin-left: auto; margin-right: auto;"> <thead> <tr> <th colspan="4">Acceptable quantity</th> </tr> <tr> <th>Length</th> <th>Width</th> <th>Zone A</th> <th>Zone B</th> </tr> </thead> <tbody> <tr> <td>--</td> <td>$W \leq 0.05$</td> <td>Any number</td> <td rowspan="3">Any number</td> </tr> <tr> <td>$L \leq 2.0$</td> <td>$W \leq 0.1$</td> <td>3</td> </tr> <tr> <td>$L > 2.0$</td> <td></td> <td>0</td> </tr> </tbody> </table> <p style="text-align: center;">Total acceptable quantity: 3</p>	Acceptable quantity			Size	Zone A	Zone B	$\varnothing < 0.1$	Any number	Any number	$0.1 < \varnothing < 0.2$	3	$0.2 < \varnothing < 0.25$	1	$0.25 < \varnothing$	0	Acceptable quantity				Length	Width	Zone A	Zone B	--	$W \leq 0.05$	Any number	Any number	$L \leq 2.0$	$W \leq 0.1$	3	$L > 2.0$		0
Acceptable quantity																																			
Size	Zone A	Zone B																																	
$\varnothing < 0.1$	Any number	Any number																																	
$0.1 < \varnothing < 0.2$	3																																		
$0.2 < \varnothing < 0.25$	1																																		
$0.25 < \varnothing$	0																																		
Acceptable quantity																																			
Length	Width	Zone A	Zone B																																
--	$W \leq 0.05$	Any number	Any number																																
$L \leq 2.0$	$W \leq 0.1$	3																																	
$L > 2.0$		0																																	
Minor	Polariser scratch	Scratch on protective film is permitted Scratch on polariser: same as No. 1																																	
Minor	Polariser bubble	<p>$\varnothing = (X+Y)/2$</p>  <table border="1" style="margin-left: auto; margin-right: auto;"> <thead> <tr> <th colspan="3">Acceptable quantity</th> </tr> <tr> <th>Size</th> <th>Zone A</th> <th>Zone B</th> </tr> </thead> <tbody> <tr> <td>$\varnothing < 0.5$</td> <td>Any number</td> <td rowspan="2">Any number</td> </tr> <tr> <td>$\varnothing > 0.5$</td> <td>0</td> </tr> </tbody> </table> <p style="text-align: center;">Total acceptable quantity: 3</p>	Acceptable quantity			Size	Zone A	Zone B	$\varnothing < 0.5$	Any number	Any number	$\varnothing > 0.5$	0																						
Acceptable quantity																																			
Size	Zone A	Zone B																																	
$\varnothing < 0.5$	Any number	Any number																																	
$\varnothing > 0.5$	0																																		

Product No.	DD-9664FC-2A	REV. A
		REV.

Page	24 / 29
------	---------

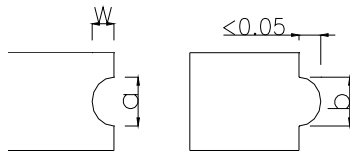
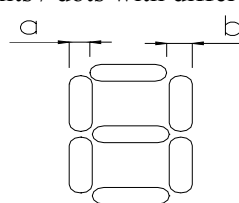
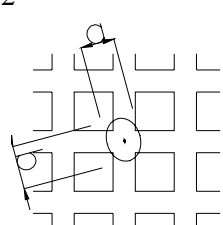
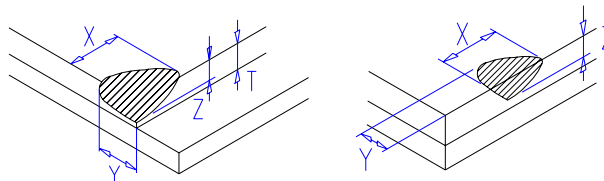
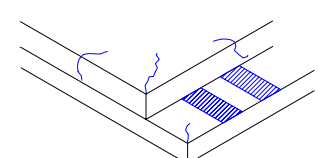
Class	Item	Criteria																												
Minor	Segment deformation	<p>1b. Pin hole on dot matrix display</p>  <table border="1" data-bbox="1005 302 1404 481"> <thead> <tr> <th colspan="2">Acceptable quantity</th> </tr> <tr> <th>Size</th> <th></th> </tr> </thead> <tbody> <tr> <td>$a, b < 0.1$</td> <td>Any number</td> </tr> <tr> <td>$(a+b)/2 \le 0.1$</td> <td>Any number</td> </tr> <tr> <td>$0.5 < \varnothing < 1.0$</td> <td>3</td> </tr> </tbody> </table> <p>Total acceptable quantity: 7</p> <p>2. Segments / dots with different width</p>  <table border="1" data-bbox="1005 683 1404 795"> <thead> <tr> <th colspan="2">Acceptable</th> </tr> </thead> <tbody> <tr> <td>$a \geq b$</td> <td>$a/b \leq 4/3$</td> </tr> <tr> <td>$a < b$</td> <td>$a/b > 4/3$</td> </tr> </tbody> </table> <p>3. Alignment layer defect $\varnothing = (a+b)/2$</p>  <table border="1" data-bbox="1005 862 1404 1086"> <thead> <tr> <th colspan="2">Acceptable quantity</th> </tr> <tr> <th>Size</th> <th></th> </tr> </thead> <tbody> <tr> <td>$\varnothing \leq 0.4$</td> <td>Any number</td> </tr> <tr> <td>$0.4 < \varnothing \leq 1.0$</td> <td>5</td> </tr> <tr> <td>$1.0 < \varnothing \leq 1.5$</td> <td>3</td> </tr> <tr> <td>$1.5 < \varnothing \leq 2.0$</td> <td>2</td> </tr> </tbody> </table> <p>Total acceptable quantity: 7</p>	Acceptable quantity		Size		$a, b < 0.1$	Any number	$(a+b)/2 \le 0.1$	Any number	$0.5 < \varnothing < 1.0$	3	Acceptable		$a \geq b$	$a/b \leq 4/3$	$a < b$	$a/b > 4/3$	Acceptable quantity		Size		$\varnothing \leq 0.4$	Any number	$0.4 < \varnothing \leq 1.0$	5	$1.0 < \varnothing \leq 1.5$	3	$1.5 < \varnothing \leq 2.0$	2
Acceptable quantity																														
Size																														
$a, b < 0.1$	Any number																													
$(a+b)/2 \le 0.1$	Any number																													
$0.5 < \varnothing < 1.0$	3																													
Acceptable																														
$a \geq b$	$a/b \leq 4/3$																													
$a < b$	$a/b > 4/3$																													
Acceptable quantity																														
Size																														
$\varnothing \leq 0.4$	Any number																													
$0.4 < \varnothing \leq 1.0$	5																													
$1.0 < \varnothing \leq 1.5$	3																													
$1.5 < \varnothing \leq 2.0$	2																													
Minor	Panel Chipping	<p>$X \leq 1/6$ Panel length $Y \leq 1$ $Z \leq T$</p> 																												
Minor	Panel Cracking	<p>Cracks not allowed</p> 																												
Minor	Copper exposed (pin or film)	Not allowed if visible by eye inspection																												
Minor	Film or Trace Damage	Not allowed if affects electrical function																												

Product No.	DD-9664FC-2A	REV. A
		REV.

Page	25 / 29
------	---------

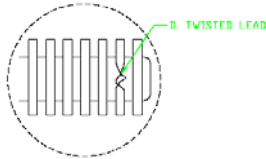
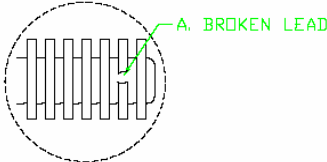
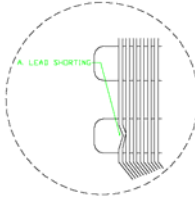
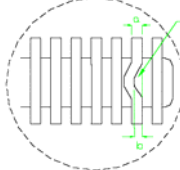
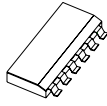
Class	Item	Criteria													
Minor	Contact Lead Twist	Not allowed 													
Minor	Contact Lead Broken	Not allowed 													
Minor	Contact Lead Bent	Not allowed if bent lead causes short circuit 													
		Not allowed if bent lead extends horizontally more than 50% of its width 													
Minor	Colour uniformity	Level of sample for approval set as limit sample													
Major		No unmelted solder paste should be present on PCB													
Critical		Cold solder joints, missing solder connections, or oxidation are not allowed													
Minor		No residue or solder balls on PCB are allowed													
Critical		Short circuits on components are not allowed													
Minor	Tray particles	<table border="1"> <thead> <tr> <th></th> <th>Size</th> <th>Quantity</th> </tr> </thead> <tbody> <tr> <td rowspan="2">On tray</td> <td>$\varnothing < 0.2$</td> <td>Any number</td> </tr> <tr> <td>$\varnothing > 0.25$</td> <td>4</td> </tr> <tr> <td rowspan="2">On display</td> <td>$\varnothing \geq 0.25$</td> <td>2</td> </tr> <tr> <td>L = 3</td> <td>1</td> </tr> </tbody> </table>		Size	Quantity	On tray	$\varnothing < 0.2$	Any number	$\varnothing > 0.25$	4	On display	$\varnothing \geq 0.25$	2	L = 3	1
	Size	Quantity													
On tray	$\varnothing < 0.2$	Any number													
	$\varnothing > 0.25$	4													
On display	$\varnothing \geq 0.25$	2													
	L = 3	1													

Product No.	DD-9664FC-2A	REV. A
		REV.

Page	26 / 29
------	---------

8.3 DEALING WITH CUSTOMER COMPLAINTS

8.3.1 Non-conforming analysis

Purchaser should supply Densitron with detailed data of non-conforming sample. After accepting it, Densitron should complete the analysis in two weeks from receiving the sample. If the analysis cannot be completed on time, Densitron must inform the purchaser.

8.3.2 Handling of non-conforming displays

If any non-conforming displays are found during customer acceptance inspection which Densitron is clearly responsible for, return them to Densitron. Both Densitron and customer should analyse the reason and discuss the handling of non-conforming displays when the reason is not clear. Equally, both sides should discuss and come to agreement for issues pertaining to modification of Densitron quality assurance standard.

Product No.	DD-9664FC-2A	REV. A
		REV.

Page	27 / 29
------	---------

9 RELIABILITY SPECIFICATION

9.1 CONTENTS OF RELIABILITY TESTS

Test Item	Test Condition	Evaluation and assessment
High Temperature Operation	70°C±2, 240 hours	No abnormalities in function and appearance
Low Temperature Operation	-30°C±2, 240 hours	No abnormalities in function and appearance
High Temperature Storage	80°C±2, 240 hours	No abnormalities in function and appearance
Low Temperature Storage	-40°C±2, 240 hours	No abnormalities in function and appearance
High Temperature & High Humidity Operation	60°C, 90%RH, 120 hours	No abnormalities in function and appearance
Thermal Shock	24 cycles of -40°C to 85°C, 1 hour dwell	No abnormalities in function and appearance

* The samples used for the above tests do not include polarizer.

* No moisture condensation is observed during tests.

9.2 FAILURE CHECK STANDARD

After the completion of the described reliability test, the samples were left at room temperature for 2 hrs prior to conducting the failure test at 23±5 °C ; 55±15% RH.

9.3 LIFE TIME

Item	Description
1	Function, performance, appearance, etc. shall be free from remarkable deterioration more than 10,000 hours under ordinary operating and storage conditions of room temperature (25±10 °C), normal humidity (45±20% RH), and in area not exposed to direct sunlight.
2	End of lifetime is specified as 50% of initial brightness.

Product No.	DD-9664FC-2A	REV. A
		REV.

Page	28 / 29
------	---------

10 HANDLING PRECAUTIONS

Safety

If the panel breaks, be careful not to get the organic substance in your mouth or in your eyes.
If the organic substance touches your skin or clothes, wash it off immediately using soap and plenty of water.

Mounting and Design

Place a transparent plate (e.g. acrylic, polycarbonate or glass) on the display surface to protect the display from external pressure. Leave a small gap between the transparent plate and the display surface.

Design the system so that no input signal is given unless the power supply voltage is applied.

Caution during OLED cleaning

Lightly wipe the display surface with a soft cloth soaked with Isopropyl alcohol, Ethyl alcohol or Trichlorotrifluoroethane.

Do not wipe the display surface with dry or hard materials that will damage the polariser surface.
Do not use aromatic solvents (toluene and xylene), or ketonic solvents (ketone and acetone).

Caution against static charge

As the display uses C-MOS LSI drivers, connect any unused input terminal to V_{DD} or V_{SS} . Do not input any signals before power is turned on.

Also, ground your body, work/assembly table and assembly equipment to protect against static electricity.

Packaging

Displays use OLED elements, and must be treated as such. Avoid strong shock and drop from a height.

To prevent displays from degradation, do not operate or store them exposed directly to sunshine or high temperature/humidity.

Caution during operation

It is indispensable to drive the display within the specified voltage limit since excessive voltage shortens its life.

Other Precautions

When a display module is operated for a long of time with fixed pattern may remain as an after image or slight contrast deviation may occur.

Nonetheless, if the operation is interrupted and left unused for a while, normal state can be restored.
Also, there will be no problem in the reliability of the module.

Storage

Store the display in a dark place where the temperature is $25^{\circ}\text{C} \pm 10^{\circ}\text{C}$ and the humidity below 50%RH.

Store the display in a clean environment, free from dust, organic solvents and corrosive gases.
Do not crash, shake or jolt the display (including accessories).

Product No.	DD-9664FC-2A	REV. A
		REV.

Page	29 / 29
------	---------

X-ON Electronics

Largest Supplier of Electrical and Electronic Components

Click to view similar products for [densitron](#) manufacturer:

Other Similar products are found below :

[DMT024QVNUNT0-2C](#) [DMT028QVNTNT0S-1A](#) [DMT028QVHXCMI-1A](#) [DMT024QVNUCMI-2A](#) [LMR4048BG2C16HNG/5V](#)