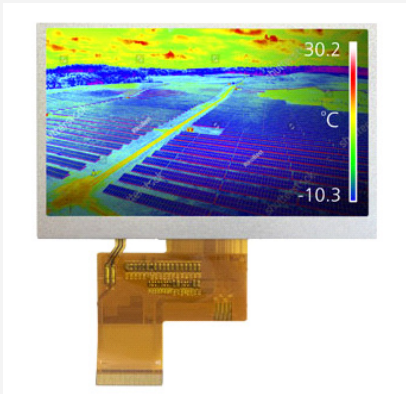

TFT DISPLAY MODULE

Product Specification

Customer	Standard		
Product Number	DMT043QQNTNT0-1C		
Customer Part Number			
Customer Approval		Date:	

Internal Approvals

Product Mgr	Doc. Control	Electr. Eng
Luo Luo	Luo Luo	Eric Wan
Date: 14/11/17	Date: 14/11/17	Date: 02/11/17

Revision Record

Rev.	Date	Page	Chapt.	Comment	ECR no.
1.0	1-July-17	All	All	Initial Release	
1.1	02-Nov-17	All	6	Modify the electrical Characteristics and test Specification	

Table of Contents

1.0	MAIN FEATURES	5
2.0	MECHANICAL SPECIFICATION.....	6
2.1	MECHANICAL CHARACTERISTICS.....	6
2.2	MECHANICAL DRAWING.....	7
3.0	ELECTRICAL SPECIFICATION.....	8
3.1	ABSOLUTE MAXIMUM RATINGS	8
3.1.1	TFT	8
3.2	ELECTRICAL CHARACTERISTICS.....	8
3.2.1	TFT	8
3.3	INTERFACE PIN ASSIGNMENT	9
3.3.1	TFT Pin Assignment.....	9
3.4	TIMING CHARACTERISTICS.....	11
3.4.1	Clock and Data Input Timing Diagram.....	11
3.4.2	Parallel RGB Input Timing Table	11
3.4.2.1	SYNC Mode Timing Diagram.....	12
3.4.2.2	SYNC-DE Mode Timing Diagram	13
3.4.3	Serial-8 bit RGB Input Timing Table	14
3.4.3.1	SYNC Mode Timing Diagram	14
3.4.3.2	SYNC-DE Mode Timing Diagram	14
3.4.4	Power on sequence.....	15
3.4.5	Power off sequence	15
4.0	OPTICAL SPECIFICATION.....	16
4.1	OPTICAL CHARACTERISTICS	16

4.1.1 Test Method	17
5.0 BACKLIGHT SPECIFICATION	18
5.1 LED DRIVING CONDITIONS.....	18
5.2 LED CIRCUIT	18
6.0 QUALITY ASSURANCE SPECIFICATION	19
6.1 DELIVERY INSPECTION STANDARDS	19
6.1.1 Inspection Conditions	19
6.1.2 Environmental Conditions.....	19
6.1.3 Sampling Conditions	19
6.1.4 Definition of Area	20
6.1.5 Basic Principle.....	20
6.1.6 Inspection Criteria	21
6.1.7 Classification of Defects	23
6.1.8 Identification / marking criteria	23
6.2 DEALING WITH CUSTOMER COMPLAINTS	24
6.2.1 Non-conforming analysis	24
6.2.2 Handling of non-conforming displays	24
7.0 RELIABILITY SPECIFICATION.....	25
7.1 RELIABILITY TESTS.....	25
8.0 HANDLING PRECAUTIONS	26

1.0 Main Features

Item	Contents
Screen Size	4.3" Diagonal
Display Format	480 x RGB x 272 Dots
N° of Colour	65K/262K/16.7M
Active Area	95.04(H) x 53.86(V)
LCD Type	TFT
Mode	Transmissive / Normally Black
Viewing Direction	Full view angle(VA)
TFT Interface	16/18/24 Bit Parallel RGB Serial-8bit RGB
TFT Driver IC	OTA5180A
Backlight Type	LED
Operating Temperature	-30°C ~ +85°C
Storage Temperature	-40°C ~ +90°C
RoHS compliant	Yes

2.0 Mechanical Specification

2.1 Mechanical Characteristics

Item	Characteristic	Unit
Overall Dimensions	105.4 mm (H) x 67.15mm (V) x 2.86mm (D)	mm
pixel Pitch	198 (H) x 198(V)	μm
Weight	22	g

2.2 Mechanical Drawing

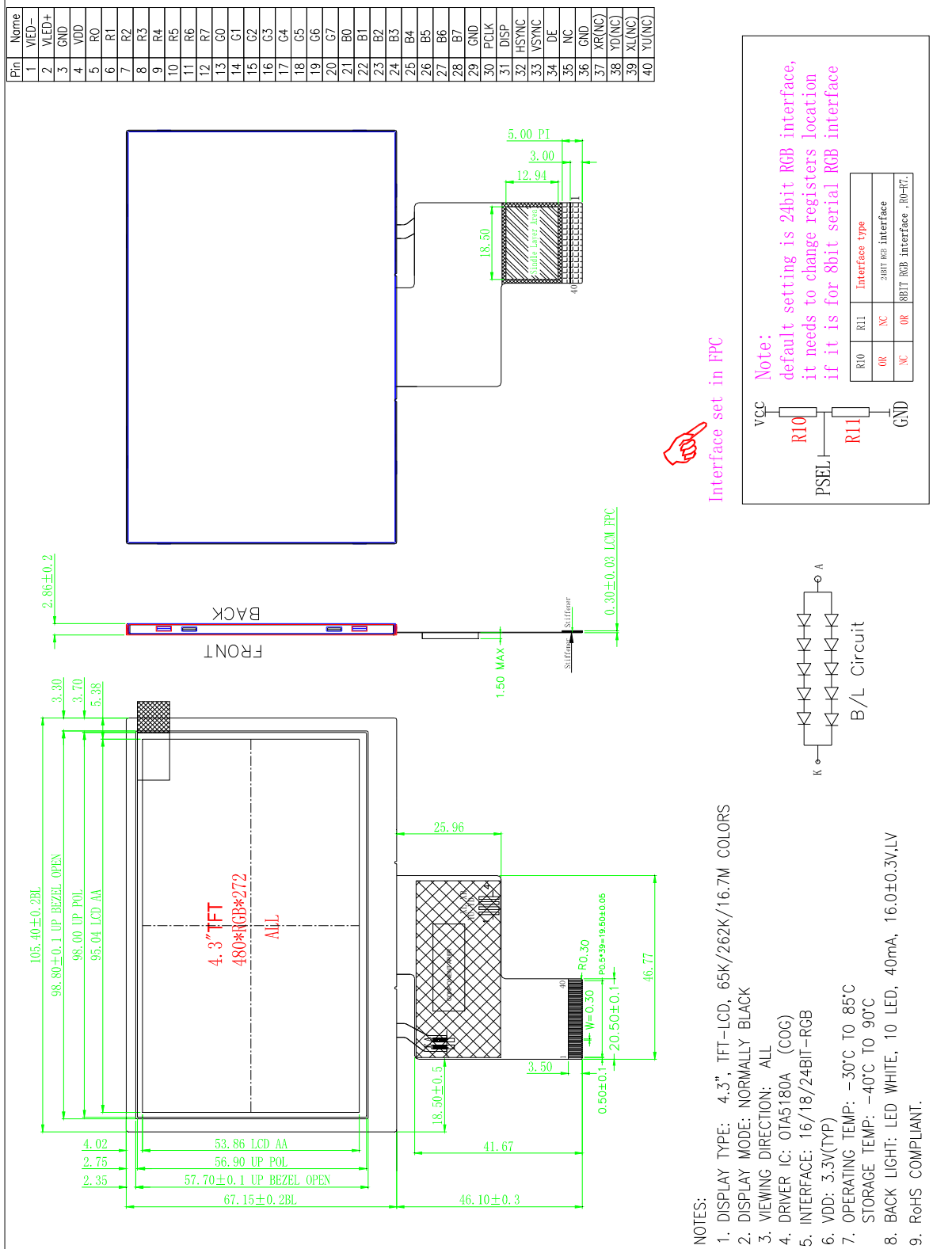

3.0 Electrical Specification

3.1 Absolute Maximum Ratings

3.1.1 TFT

Item	Symbol	Condition	Min	Max	Unit	Note
Power Supply Voltage LCM	VDD		-0.3	4.5	V	
Operating Temperature	TOP		-30	85	°C	1
Storage Temperature	TST		-40	90	°C	1,2,3

Note 1. 90 % RH Max for $T_a < 50\text{ }^\circ\text{C}$, and 60% RH for $T_a \geq 50\text{ }^\circ\text{C}$.

Note 2. In case of below $0\text{ }^\circ\text{C}$, the response time of liquid crystal (LC) becomes slower and the colour of panel becomes darker than normal one. Level of retardation depends on temperature, because of LC's characteristic.

Note 3. Only operation is guaranteed at operating temperature. Contrast, response time, another display quality are evaluated at $+25\text{ }^\circ\text{C}$.

3.2 Electrical Characteristics

3.2.1 TFT

Item	Symbol	Condition	Min	Typ	Max	Unit	Note
Supply Voltage	VDD	$T_a = 25\text{ }^\circ\text{C}$	3.0	3.3	3.6	V	
Input Voltage for Logic	V _{IH}		0.7VDD	-	VDDIO	V	
	V _{IL}		GND	-	0.3VDD	V	
Output Voltage for Logic	V _{OH}		0.8VDD	-	VDD	V	
	V _{OL}		GND	-	0.2VDD	V	
Current Consumption	IDD		-	13	-	mA	1

Note 1: The specified power consumption is under the conditions of $VDD = 3.3V$.

3.3 Interface Pin Assignment

3.3.1 TFT Pin Assignment

No.	Symbol	Function
1	VLED--	Cathode pin Of backlight
2	VLED+	Anode pin of backlight
3	GND	Ground.
4	VDD	Supply voltage(3.3V).
5	R0	Red data input.
6	R1	Red data input.
7	R2	Red data input.
8	R3	Red data input.
9	R4	Red data input.
10	R5	Red data input.
11	R6	Red data input.
12	R7	Red data input.
13	G0	Green data input.
14	G1	Green data input.
15	G2	Green data input.
16	G3	Green data input.
17	G4	Green data input.
18	G5	Green data input.
19	G6	Green data input.
20	G7	Green data input.
21	B0	Blue data input.
22	B1	Blue data input.
23	B2	Blue data input.
24	B3	Blue data input.
25	B4	Blue data input.
26	B5	Blue data input.
27	B6	Blue data input.
28	B7	Blue data input.

No.	Symbol	Function
29	GND	Ground.
30	PCLK	Clock signal. Latching data at the rising edge
31	DISP	Standby setting for testing, it should be connected to VDD in normal operation mode. If connected to GND, the IC is in standby mode.
32	HSYNC	Horizontal Sync input. Negative polarity.
33	VSYNC	Vertical Sync input. Negative polarity.
34	DE	Data input Enable. Active High to enable the data input Bus under "DE Mode".
35	NC	Not Connection
36	GND	Ground.
37	XR(NC)	Touch panel Right Glass Terminal(not connection)
38	YD(NC)	Touch panel Bottom Film Terminal(not connection)
39	XL(NC)	Touch panel LIFT Glass Terminal(not connection)
40	YU(NC)	Touch panel Top Film Terminal(not connection)

Note: when use Serial 8 bit RGB, data input through G0-G7

3.4 Timing Characteristics

Please refer to OTA5180A datasheet for more information

3.4.1 Clock and Data Input Timing Diagram

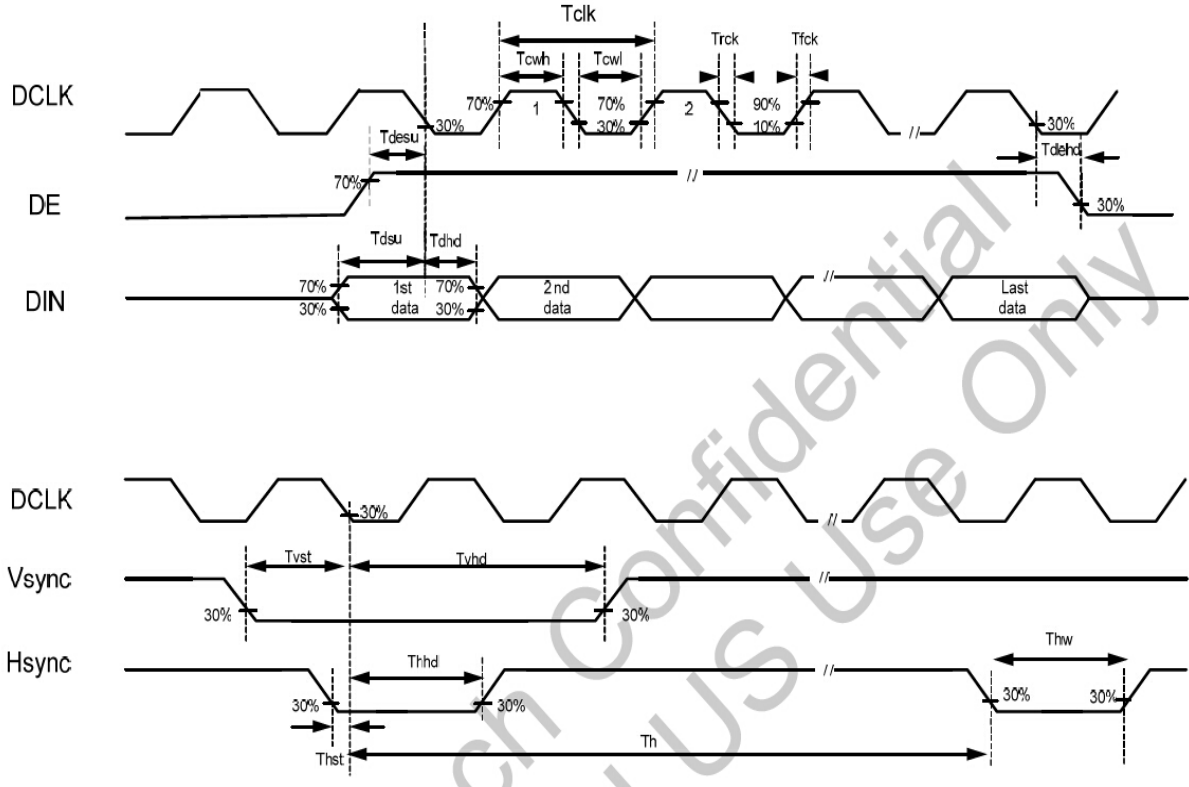

3.4.2 Parallel RGB Input Timing Table

Item	Symbol	Min.	Typ.	Max.	Unit		
DCLK Frequency	Fclk	5	9	12	MHz		
DCLK Period	Tclk	83	110	200	ns		
Hsync	Period Time	Th	490	531	605	DCLK	
	Display Period	Thdisp		480		DCLK	
	Back Porch	Thbp	8	43		DCLK	By H_BLANKING setting
	Front Porch	Thfp	2	8		DCLK	
	Pulse Width	Thw	1			DCLK	
Vsync	Period Time	Tv	275	288	335	H	
	Display Period	Tvdisp		272		H	
	Back Porch	Tvbp	2	12		H	By V_BLANKING setting
	Front Porch	Tvfp	1	4		H	
	Pulse Width	Tvw	1	10		H	

3.4.2.1 SYNC Mode Timing Diagram

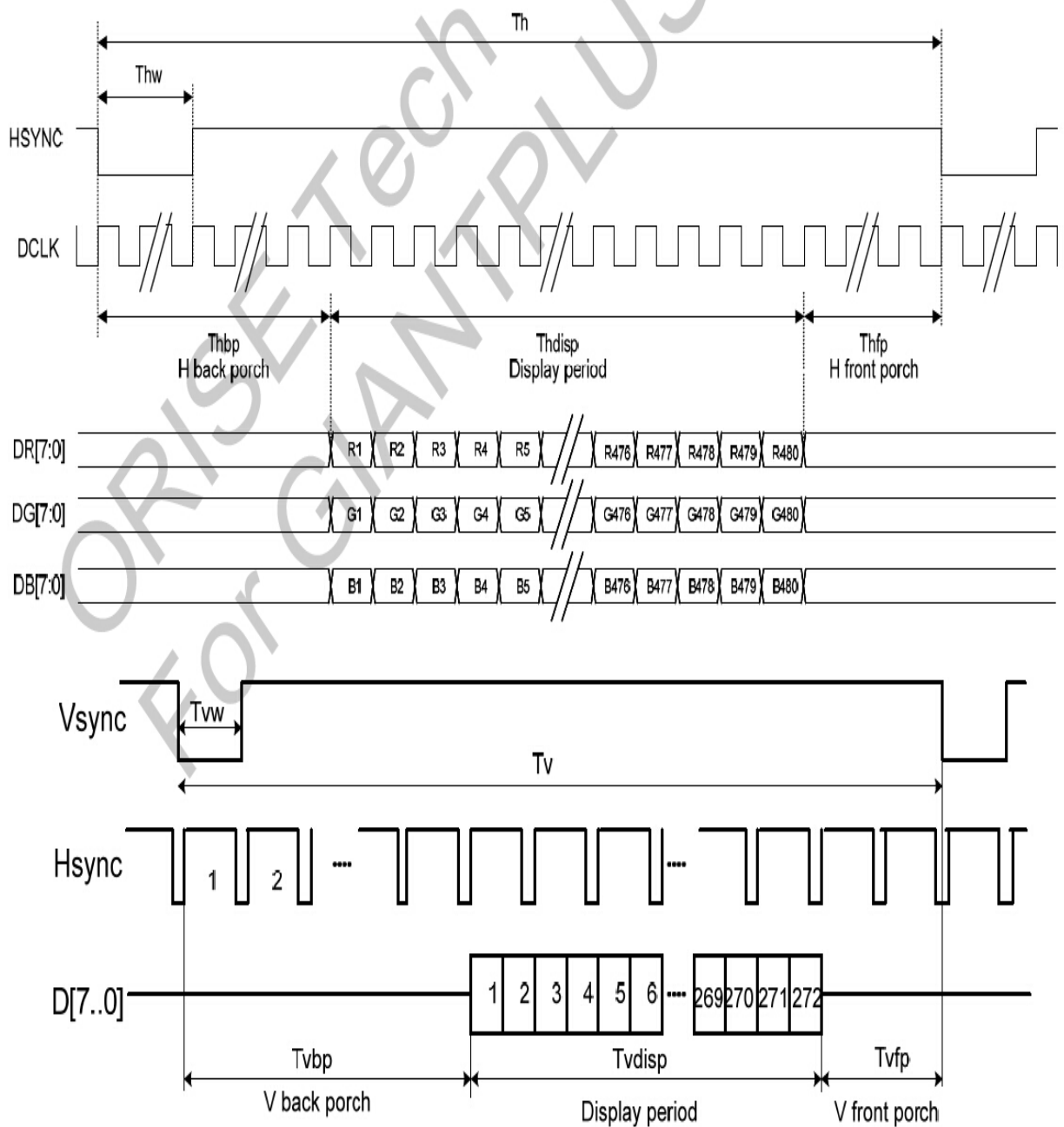

3.4.2.2 SYNC-DE Mode Timing Diagram

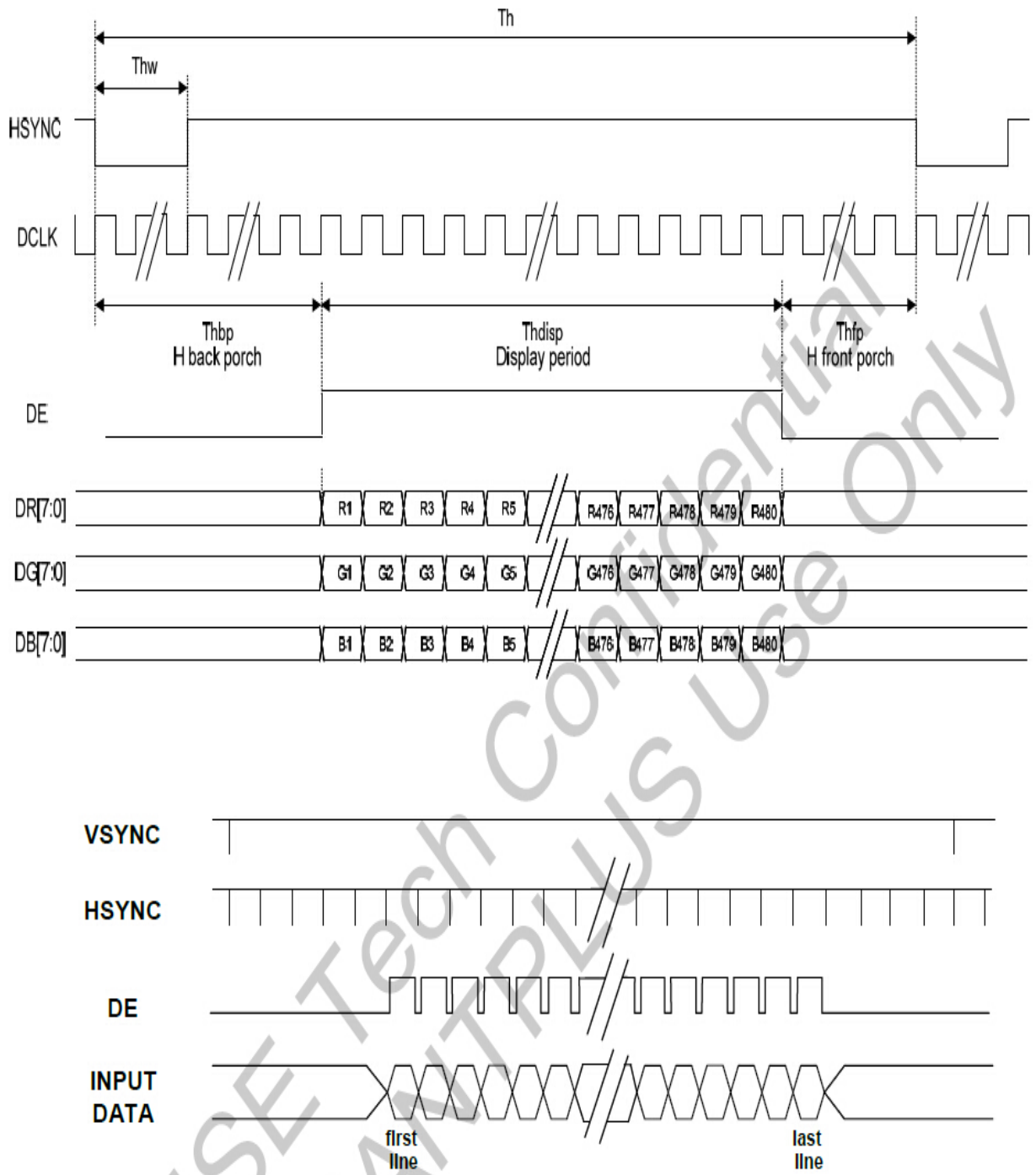

3.4.3 Serial-8 bit RGB Input Timing Table

Item	Symbol	Min.	Typ.	Max.	Unit		
DCLK Frequency	Fclk	24	27	30	MHz		
DCLK Period	Tclk	42	37	33	ns		
Hsync	Period Time	Th	1560	1716	1900	DCLK	
	Display Period	Thdisp		1440		DCLK	
	To 1 st Data Input	Thbp	108	129	255	DCLK	By H_BLANKING setting
	Front Porch	Thfp	12	168	205	DCLK	
	Pulse Width	Thw	1			DCLK	
Vsync	Period Time	Tv	274	288	335	H	
	Display Period	Tvdisp		272		H	
	Delay to 1 st Gate Output	Tvbp		12		H	By V_BLANKING setting
	Front Porch	Tvfp		3		H	
	Pulse Width	Tvw	1	10		H	

3.4.3.1 SYNC Mode Timing Diagram

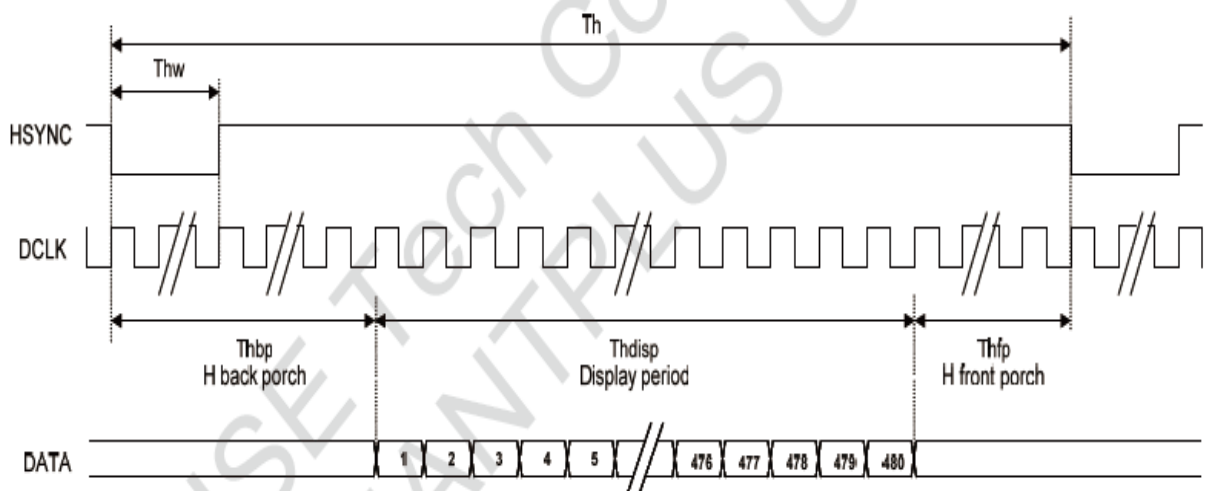

3.4.3.2 SYNC-DE Mode Timing Diagram

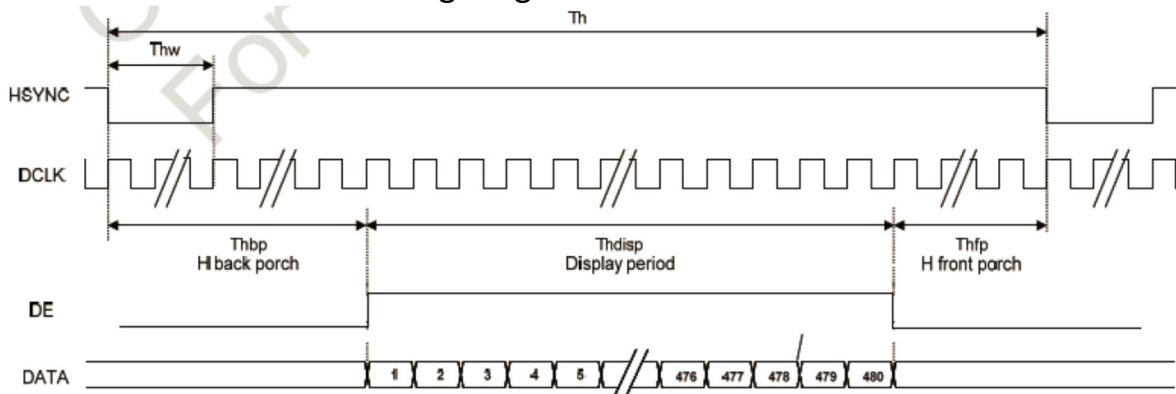

3.4.4 Power on sequence

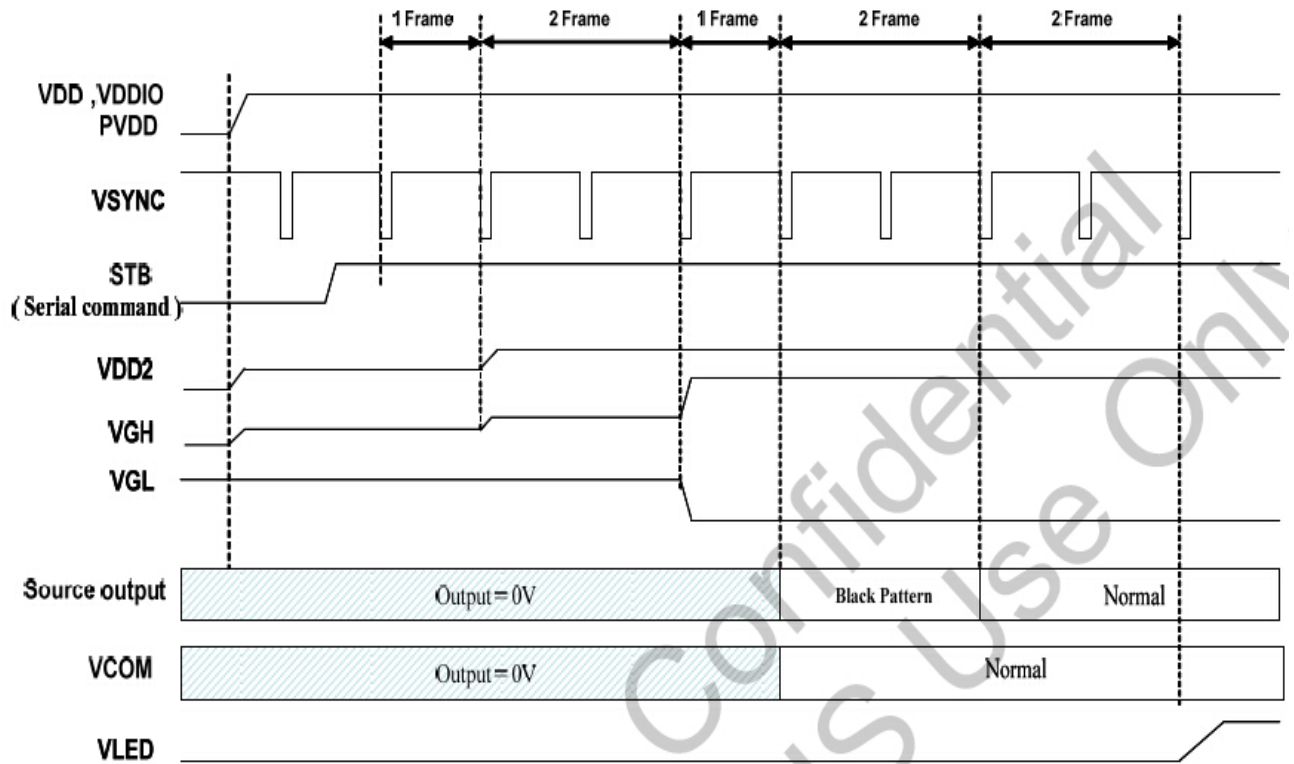

3.4.5 Power off sequence

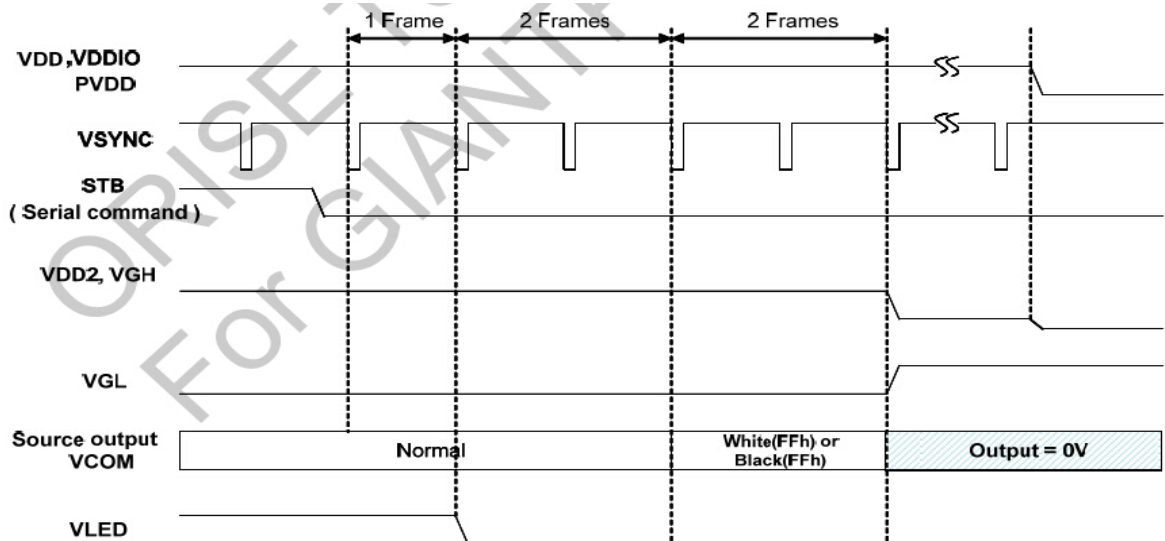

Note:

- a. When normally-black LC is used, please send black pattern to discharge the panel.
- b. When normally-white LC is applied, please send white pattern to discharge the panel.

4.0 Optical Specification

4.1 Optical Characteristics

Measuring instruments : LCD-5100, Eldim, Topcon BM-7
 Driving condition: VDD = 3.3V, VSS = 0V
 Backlight: IF=40mA
 Measured temperature: Ta = 25 °C

Item	Symbol	Condition	Min	Typ	Max	Unit	Note	
Response Time	TR+TF	$\theta=\phi=0^\circ$ Normal Viewing Angle	-	35	-	ms	2	
Contrast Ratio	CR		-	500	-		3	
Viewing Angle	Left	θ_L	CR \geq 10	70	-	deg	4	
	Right	θ_R		70	-	deg		
	Up	ϕ_U		70	-	deg		
	Down	ϕ_D		70	-	deg		
Colour Chromaticity	Red	Rx	CR \geq 10	0.602	0.622	0.642	-	5
		Ry		0.329	0.349	0.369	-	
	Green	Gx		0.336	0.356	0.376	-	
		Gy		0.582	0.602	0.622	-	
	Blue	Bx		0.132	0.152	0.172	-	
		By		0.102	0.122	0.142	-	
	White	Wx		0.287	0.327	0.367	-	
		Wy		0.339	0.379	0.419	-	
Centre Brightness			430	490	-	cd/m ²	6	
Brightness Distribution			80	-	-	%	7	

4.1.1 Test Method

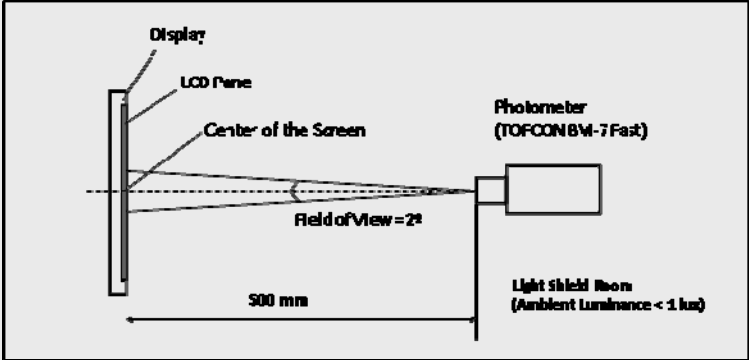
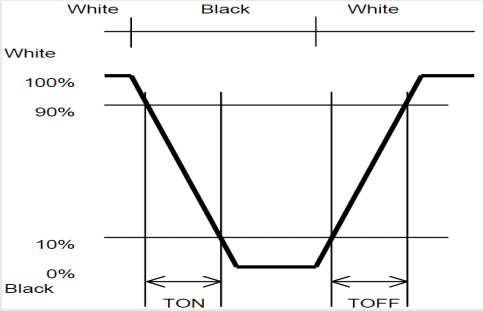
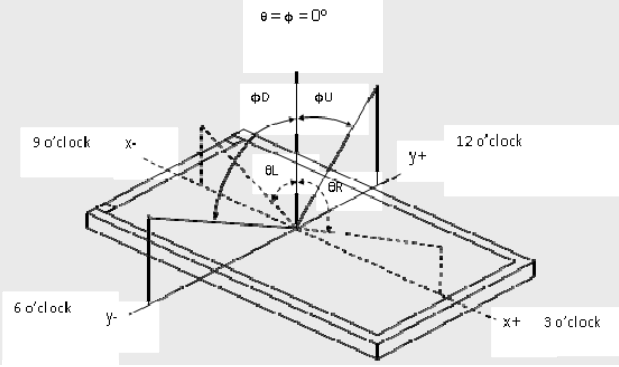
Note	Item	Test Method
1	Setup	<p>The display should be stabilised at a given temperature for 30 minutes to avoid abrupt temperature change during measuring. In order to stabilise the luminance, measurements should be executed after lighting the backlight for 30 minutes in a windless room.</p> 
2	Response time	<p>Measure output signal waveform by the luminance meter when raster of window pattern is changed from white to black and from black to white.</p> 
3	Contrast ratio	<p>Measure maximum brightness and minimum brightness at the centre of the screen by displaying raster or window pattern. Then calculate the ratio between these two values.</p> $\text{Contrast Ratio (CR)} = \frac{\text{Brightness of unselected position (white)}}{\text{Brightness of selected position (black)}}$
4	Viewing angle Horizontal θ Vertical ϕ	<p>Move the luminance meter from right to left and up and down and determinate the angles where contrast ratio is 10</p> 
5	Colour chromaticity	Measure chromaticity coordinates x and y of CIE1931 colorimetric system
6	Centre brightness	Measure the brightness at the centre of the screen
7	Brightness distribution	<p>(Brightness distribution) = $100 \times B/A \%$ A: max. brightness of the 9 points B: min. brightness of the 9 points</p>

5.0 Backlight Specification

5.1 LED Driving Conditions

Item	Symbol	Condition	Min	Typ	Max	Unit
Forward Current	IF	Ta=25 °C	30	40	-	mA
Forward Voltage	VF	Ta= 25°C		16		V
LED life time	Hr				50k	hour

Note:

- The lifetime of the LED is defined as a period till the brightness of the LED decreases to the half of its initial value.
- This figure is given as a reference purpose only, and not a guarantee.
- This figure is estimated for an LED operating alone.
The performance of an LED may differ when assembled as a monitor together with a TFT panel due to different environmental temperature.
- Estimated lifetime could vary on a different temperature and usually higher temperature could reduce the life significantly.

5.2 LED Circuit

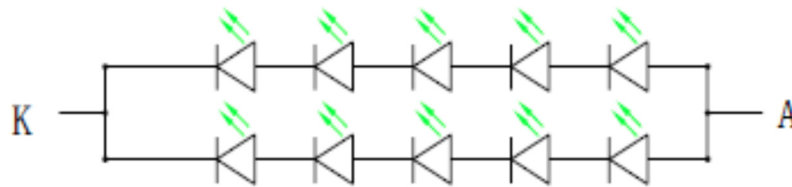

B/L Circuit

6.0 Quality Assurance Specification

6.1 Delivery Inspection Standards

6.1.1 Inspection Conditions

Inspection distance: 30 cm ± 2 cm

Viewing angle: ±45°

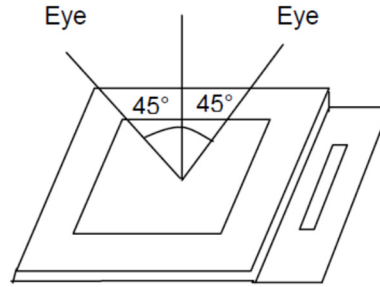

6.1.2 Environmental Conditions

Ambient temperature: 25°C ±5°C

Ambient humidity: 65±10% RH

Ambient illumination: 300~700 lux

6.1.3 Sampling Conditions

1. Lot size: quantity of shipment lot per model
2. Sampling method:

Sampling Plan		GB/T 2828-2003
		Normal inspection, Class II
AQL	Major Defect	0.65%
	Minor Defect	1.5%

No	Items to be inspected	Criteria	Classification of defects
1	Functional defects	1) No display, Open or miss line 2) Display abnormally, Short 3) Backlight no lighting, abnormal lighting. 4) TP no function	Major
2	Missing	Missing component	
3	Outline dimension	Overall outline dimension beyond the drawing is not allowed	
4	Color tone	Color unevenness, refer to limited sample	Minor
5	Spot Line defect	Light dot , Dim spot,Polarizer Bubble ; Polarizer accidented spot.	
6	Soldering appearance	Good soldering , Peeling off is not allowed.	

6.1.4 Definition of Area

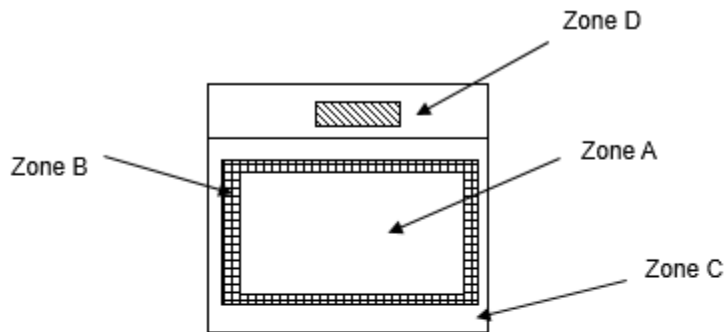

Zone A : Effective Viewing Area(Character or Digit can be seen)

Zone B : Viewing Area except Zone A

Zone C Cover (Zone A+Zone B) which can not be seen after assembly by customer .)

Zone D : IC Bonding Area

Note:

As a general rule ,visual defects in Zone C can be ignored when it doesn't effect product function or appearance after assembly by customer

6.1.5 Basic Principle

A set of sample to indicate the limit of acceptable quality level shall be discussed should a dispute occur.

6.1.6 Inspection Criteria

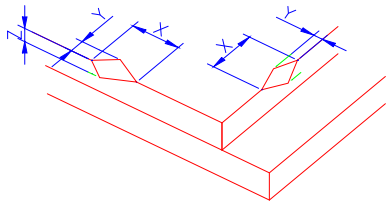
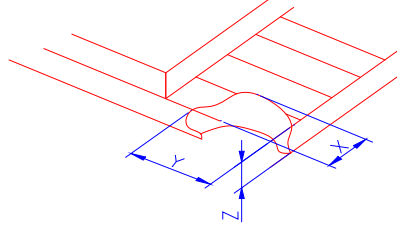
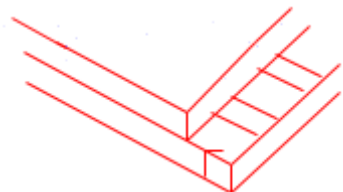
Number	Items	Criteria(mm)						
1.0 LCD Crack/Broken NOTE: X: Length Y: Width Z: Height L: Length of ITO, T: Height of LCD	(1) The edge of LCD broken	 <table border="1" data-bbox="798 616 1428 739"> <thead> <tr> <th>X</th> <th>Y</th> <th>Z</th> </tr> </thead> <tbody> <tr> <td>≤3.0mm</td> <td><Inner border line of the seal</td> <td>≤T</td> </tr> </tbody> </table>	X	Y	Z	≤3.0mm	<Inner border line of the seal	≤T
	X	Y	Z					
	≤3.0mm	<Inner border line of the seal	≤T					
(2)LCD corner broken	 <table border="1" data-bbox="798 1052 1428 1176"> <thead> <tr> <th>X</th> <th>Y</th> <th>Z</th> </tr> </thead> <tbody> <tr> <td>≤3.0mm</td> <td>≤L</td> <td>≤T</td> </tr> </tbody> </table>	X	Y	Z	≤3.0mm	≤L	≤T	
X	Y	Z						
≤3.0mm	≤L	≤T						
(3) LCD crack	 <p style="text-align: center;">Crack Not allowed</p>							

2.0	Spot defect	① light dot (LCD/TP/Polarizer black/white spot , light dot, pinhole, dent, stain)				
		Zone		Acceptable Qty		
		Size (mm)	A	B	C	
		$\Phi \leq 0.10$	Ignore			Ignore
		$0.10 < \Phi \leq 0.25$	3(distance $\geq 10\text{mm}$)			
		$0.25 < \Phi \leq 0.3$	2			
		$\Phi > 0.35$	0			
		② Dim spot (LCD/TP/Polarizer dim dot, light leakage, dark spot)				
		Zone		Acceptable Qty		
		Size (mm)	A	B	C	
$\Phi \leq 0.1$	Ignore			Ignore		
$0.10 < \Phi \leq 0.25$	3(distance $\geq 10\text{mm}$)					
$0.25 < \Phi \leq 0.3$	2					
$\Phi > 0.35$	0					
③ Polarizer accidented spot						
Zone		Acceptable Qty				
Size (mm)	A	B	C			
$\Phi \leq 0.2$	Ignore			Ignore		
$0.3 < \Phi \leq 0.5$	2(distance $\geq 10\text{mm}$)					
$\Phi > 0.5$	0					
④ Pixel bad points (light dot, Dim dot, color dot)						
Zone		Acceptable Qty				
Size (mm)	A	B	C			
$\Phi \leq 0.1$	Ignore			Ignore		
$0.15 < \Phi \leq 0.25$	2(distance $\geq 10\text{mm}$)					
$\Phi > 0.3$	0					
⑤ Polarizer Bubble						
Zone		Acceptable Qty				
Size (mm)	A	B	C			
$\Phi \leq 0.2$	Ignore			Ignore		
$0.3 < \Phi \leq 0.4$	3(distance $\geq 10\text{m}$)					
$0.5 < \Phi \leq 0.6$	2					
$0.6 < \Phi$	0					

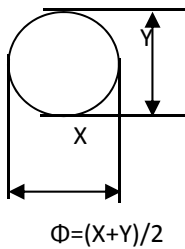

3.0	Line defect (LCD/TP /Polarizer backlight black/white line, scratch, stain)	Width(mm)	Length(mm)	Acceptable Qty		
				A	B	C
		$\Phi \leq 0.05$	Ignore	Ignore		
		$0.05 < W \leq 0.06$	$L \leq 4.0$	$N \leq 3$		
		$0.07 < W \leq 0.08$	$L \leq 3.0$	$N \leq 2$		
	$0.08 < W$	Define as spot defect				
4.0	Electronic Components SMT	Not allow missing parts, solderless connection, cold solder joint, mismatch, The positive and negative polarity opposite				
5.0	Display color& Brightness	<ol style="list-style-type: none"> 1. Color: Measuring the color coordinates, The measurement standard according to the datasheet or samples. 2. Brightness: Measuring the brightness of White screen, The measurement standard according to the datasheet or Samples. 				

Criteria (functional items)

Number	Items	Criteria (mm)
1	No display	Not allowed
2	Missing segment	Not allowed
3	Short	Not allowed
4	Backlight no lighting	Not allowed

6.1.7 Classification of Defects

Visual defects (except no or wrong label) are treated as minor defects, while electrical defects are treated as major defects.

Two minor defects are equal to one major defect in lot sampling inspection.

6.1.8 Identification / marking criteria

Any unit with illegible / wrong / double or no marking / label shall be rejected.

6.2 Dealing with Customer Complaints

6.2.1 Non-conforming analysis

Purchaser should supply Densitron with detailed data of non-conforming sample. After accepting it, Densitron should complete the analysis in two weeks from receiving the sample.

If the analysis cannot be completed on time, Densitron must inform the purchaser.

6.2.2 Handling of non-conforming displays

If any non-conforming displays are found during customer acceptance inspection which Densitron is clearly responsible for, return them to Densitron.

Both Densitron and customer should analyse the reason and discuss the handling of non-conforming displays when the reason is not clear.

Equally, both sides should discuss and come to agreement for issues pertaining to modification of Densitron quality assurance standard.

7.0 Reliability Specification

7.1 Reliability Tests

Test Item		Test Condition		Sample Size
Durability Test	High Temperature Operation	Ta= 85°C	96h	3pcs
	Low Temperature Operation	Ta=-30°C	96h	3pcs
	High Temperature Storage	Tp= 90°C	96h	3pcs
	Low Temperature Storage	Tp= -40°C	96h	3pcs
	ESD Test	150pF, 330Ω, ±6KV (Contact)/±8KV (Air), 5 Points/panel, 10 times/point		3pcs
	Thermal Shock Resistance	The sample should be allowed to stand the following 5 cycles of operation: LTS for 30 minutes -> normal temperature for 5 minutes -> HTS for 30 minutes -> normal temperature for 5 minutes, as one cycle, then taking it out and drying it at normal temperature, and allowing it stand for 24 hours		3pcs
	Box Drop Test	1 Corner 3 Edges 6 faces, 80 cm (Medium Box)		1 box

Note: Ta=ambient temperature Tp= Panel temperature

Notes:

1. No dew condensation to be observed.
2. The function test shall be conducted after 4 hours storage at the normal temperature and humidity after removed from the test chamber.
3. No cosmetic or functional defects should be allowed.
4. Total current consumption should be less than twice the initial value.

8.0 Handling Precautions

Safety

If the LCD panel breaks, be careful not to get the liquid crystal fluid in your mouth or in your eyes.

If the liquid crystal touches your skin or clothes, wash it off immediately using soap and plenty of water.

Mounting and Design

Place a transparent plate (e.g. acrylic, polycarbonate or glass) on the display surface to protect the display from external pressure. Leave a small gap between the transparent plate and the display surface.

When assembling with a zebra connector, clean the surface of the pads with alcohol and keep the surrounding air very clean.

Design the system so that no input signal is given unless the power supply voltage is applied.

Caution during LCD cleaning

Lightly wipe the display surface with a soft cloth soaked with Isopropyl alcohol, Ethyl alcohol or Trichlorotrifluoroethane.

Do not wipe the display surface with dry or hard materials that will damage the polariser surface.

Do not use aromatic solvents (toluene and xylene), or ketonic solvents (ketone and acetone).

Caution against static charge

As the display uses C-MOS LSI drivers, connect any unused input terminal to VDD or VSS. Do not input any signals before power is turned on. Also, ground your body, work/assembly table and assembly equipment to protect against static electricity.

Packaging

Displays use LCD elements, and must be treated as such. Avoid strong shock and drop from a height. To prevent displays from degradation, do not operate or store them exposed directly to sunshine or high temperature/humidity.

Caution during operation

It is indispensable to drive the display within the specified voltage limit since excessive voltage shortens its life. Direct current causes an electrochemical reaction with remarkable deterioration of the display quality. Give careful consideration to prevent direct current during ON/OFF timing and during operation. Response time is extremely delayed at temperatures lower than the operating temperature range while, at high temperatures, displays become dark. However, this phenomenon is reversible and does not mean a malfunction or a display that has been permanently damaged. If the display area is pushed on hard during operation, some graphics will be abnormally displayed but returns to a normal condition after turning off the display once. Even a small amount of condensation on the contact pads (terminals) can cause an electro-chemical reaction which causes missing rows and columns. Give careful attention to avoid condensation.

Storage

Store the display in a dark place where the temperature is $25^{\circ}\text{C} \pm 10^{\circ}\text{C}$ and the humidity below 50%RH. Store the display in a clean environment, free from dust, organic solvents and corrosive gases. Do not crash, shake or jolt the display (including accessories).

X-ON Electronics

Largest Supplier of Electrical and Electronic Components

Click to view similar products for [densitron](#) manufacturer:

Other Similar products are found below :

[DMT024QVNUNT0-2C](#) [DMT028QVNTNT0S-1A](#) [DMT028QVHXCMI-1A](#) [DMT024QVNUCMI-2A](#) [LMR4048BG2C16HNG/5V](#)