

LIQUID CRYSTAL DISPLAY MODULE

Product Specification

DENSITRON	STANDARD LCD MODULE	
PRODUCT NUMBER	LM/TS 3234 – LM/TS 4234 – LM/TS 6234	
DEFINITION	Display 240*128 dots	Date 19/04/04

INTERNAL APPROVALS				
Quality Mgr	Product Mgr	Project Leader	Mech. Eng	Electr. Eng
Date:	Date:	Date:	Date:	Date:

TABLE OF CONTENTS

1	PART NUMBER DESCRIPTION FOR AVAILABLE OPTIONS	4
2	MAIN FEATURES	5
3	MECHANICAL SPECIFICATION	6
3.1	MECHANICAL CHARACTERISTICS.....	6
3.2	MECHANICAL DRAWING.....	7
4	ELECTRICAL SPECIFICATION	8
4.1	ABSOLUTE MAXIMUM RATINGS.....	8
4.2	ELECTRICAL CHARACTERISTICS.....	8
4.3	INTERFACE PIN ASSIGNMENT	9
4.4	BLOCK DIAGRAM.....	10
4.5	POWER SUPPLY CIRCUIT.....	11
4.6	DISPLAY CONTROL INSTRUCTION	12
4.7	CHARACTER ROM MAP.....	35
4.8	TIMING CHARACTERISTICS.....	37
5	OPTICAL SPECIFICATION	38
6	TOUCH SCREEN SPECIFICATION	40
6.1	TOUCH SCREEN ELECTRICAL CHARACTERISTICS.....	40
6.2	TOUCH SCREEN MECHANICAL CHARACTERISTICS.....	40
6.3	TOUCH SCREEN MECHANICAL DRAWING.....	41
7	BACKLIGHT SPECIFICATION	42
7.1	LED BACKLIGHT CHARACTERISTICS	42
7.1.1	WHITE EDGE STANDARD LED BACKLIGHT CHARACTERISTICS.....	42
7.1.2	YELLOW GREEN STANDARD LED BACKLIGHT CHARACTERISTICS.....	42
7.2	CCFL BACKLIGHT CHARACTERISTICS	43
8	QUALITY ASSURANCE SPECIFICATION	44
8.1	CONFORMITY	44
8.2	DELIVERY ASSURANCE.....	44
8.2.1	<i>Delivery inspection standards</i>	44
8.2.2	<i>Zone definition</i>	45
8.2.3	<i>Visual inspection</i>	45
8.2.4	<i>Standard of appearance inspection</i>	46
9	RELIABILITY SPECIFICATION	48
10	HANDLING PRECAUTIONS	49

REVISION RECORD

Rev.	Date	Page	Chapt.	Comment	ECR no.
1	19/04/04			Initial Specification	

1 PART NUMBER DESCRIPTION FOR AVAILABLE OPTIONS

LM ①234 ②③ - ④⑤⑥ ⑦

①

BACKLIGHT TYPE

- 3 = Module without Backlight or with EL Backlight
- 4 = Module with LED Backlight
- 6 = Module with CCFL Backlight

②

POLARIZER TYPE

- B = Transflective: light background
- E = Transmissive: dark background

③

BACKLIGHT COLOR

- G = Yellow-Green (Standard)
- W = White LED
- None if CCFL Backlight

④

FLUID TYPE AND POWER SUPPLY

- D = Standard temperature range with external negative voltage operation
- S = Standard temperature range with on-board negative voltage generation
- H = Wide temperature range with external negative voltage operation
- W = Wide temperature range with on-board negative voltage generator

⑤

TEMPERATURE COMPENSATION CIRCUIT

- N = Without on board temperature compensation circuit
- C = With on board temperature compensation circuit

⑥

COLOR FOR STN FLUID

- B = STN Blue background (available for E polarizer type only)
- G = STN Blue Pixels on Gray background for B polarizer types only
- Y = STN Blue Pixels on Yellow background for B polarizer types only
- F = FSTN Black Pixels or background depending on B or E polarizer type

⑦

ADDITIONAL OPTIONS

- 12 = it is mentioned if top view angle is needed
- HL = High Luminosity for White LED Backlight if available

“LM” AT THE BEGINNING OF THE PART NUMBER IS REPLACED BY “TS” IF THE MODULE HAS A TOUCH PANNEL

2 MAIN FEATURES

ITEM	CONTENTS
Display Format	240 * 128 dos
Overall Dimensions	144.0×104.0×14.3(MAX)mm
Viewing Area	114.0×64.0mm
LCD type	STN / FSTN
Mode	Avaiable in Reflective / Transflective / Transmissive
Viewing Angle	6 o'clock
Duty ratio	1/128
Driver IC	T6963C
Backlight type	None / LED / CCFL
Backlight colour	Yellow Green / White / Amber
DC/DC converter	None or Included
Operating temperature	From 0/+50°C to -20°/+70°C
Storage temperature	From -20°/+70°C to -30°/+80°C

3 MECHANICAL SPECIFICATION

3.1 MECHANICAL CHARACTERISTICS

ITEM	CHARACTERISTIC	UNIT
Display Format	240 * 128 dots	
Overall Dimensions	144.0×104.0×14.3(MAX)	mm
Viewing Area	114.0×64.0	mm
Active Area	107.98×57.58	mm
Dot Size	(L)0.43×(W)0.43	mm
Dot Pitch	(L)0.45×(W)0.45	mm
IC Controller/Driver	T6963C	

3.2 MECHANICAL DRAWING

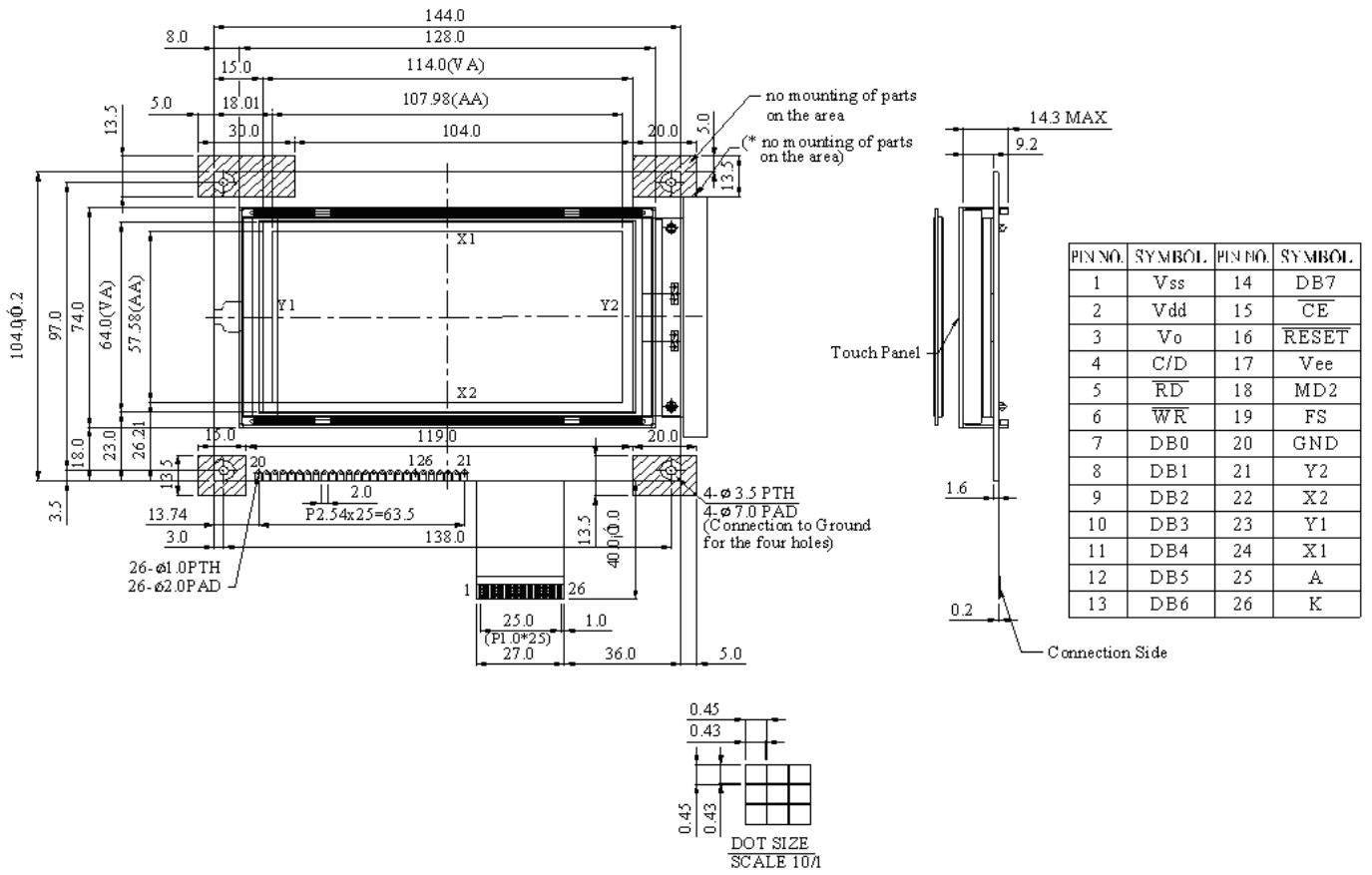

4 ELECTRICAL SPECIFICATION

4.1 ABSOLUTE MAXIMUM RATINGS

VSS = 0 V, Ta = 25 °C

Item	Symbol	Min	Typ	Max	Unit	Note
Power Supply Voltage	$V_{DD}-V_{SS}$	-0,3	-	+7,0	V	
Power Supply for LCD	$V_{DD}-V_0$	0	-	21	V	
Input Voltage	V_{in}	V_{SS}	-	V_{DD}	V	
Operating Temperature	Top	0 -20	-	+50 +70	°C	Note 1
Storage Temperature	Tst	-20 -30	-	+70 +80	°C	Note 2
Static Electricity	Be sure that you are grounded when handling displays.					

Note 1: Background colour changes slightly depending on ambient temperature. This phenomenon is reversible. Ta ≤ 70 °C: 75% RH max

Note 2: Ta ≤ 80 °C: 75% RH max

4.2 ELECTRICAL CHARACTERISTICS

VSS = 0 V, Ta = 25 °C

Item	Symbol	Condition	Min	Typ	Max	Unit
Power Supply for Logic	$V_{DD}-V_{SS}$	Ta = 25 °C	4,75	5,0	5,25	V
Input Voltage	V_{IL}	Ta = 25 °C	0	-	0,8	V
	V_{IH}	Ta = 25 °C	2,2	-	V_{DD}	V
Output Voltage	V_{OL}	Ta = 25 °C	0	-	0,4	V
	V_{OH}	Ta = 25 °C	2,4	-	V_{DD}	V
LCD Module Driving Voltage	$V_{DD}-V_0$	Ta = -20 °C	-	-	21	V
		Ta = 25 °C	-	19,1	-	V
		Ta = 70 °C	17	-	-	V
Current Consumption	* I_{DD}	$V_{DD} = 5V$ $V_{LCD} = 19,1V$	-	34	-	mA

* I_{DD} measurement condition is for all pattern ON

4.3 INTERFACE PIN ASSIGNMENT

No.	Symbol	I/O	Function
1	Vss		GND
2	Vdd		Power supply (+5 V)
3	Vo		Power supply for LCD driver
4	C/D	H / L	WR=L , C/D=H : Command Write C/D=L: Data write RD=L , C/D=H : Status Read C/D=L: Data read
5	/RD	L	Data read. Read data from T6963C when RD = L
6	/WR	L	Data write. Write data into T6963C when WR = L
7	DB0	H / L	Data bus line
8	DB1	H / L	Data bus line
9	DB2	H / L	Data bus line
10	DB3	H / L	Data bus line
11	DB4	H / L	Data bus line
12	DB5	H / L	Data bus line
13	DB6	H / L	Data bus line
14	DB7	H / L	Data bus line
15	/CE	L	L : Chip enable
16	/RESET	H / L	H : Normal ; L : Initialize T6963C
17	Vee		Negative Voltage output (-16 V)
18	MD2	H / L	H: 32 columns ; L: 40 columns
19	FS	H / L	Pins for selection of font ; H : 6 * 8 , L : 8 * 8
20	GND		GND
21	Y2		
22	X2		
23	Y1		
24	X1		
25	A		
26	K		

4.4 BLOCK DIAGRAM

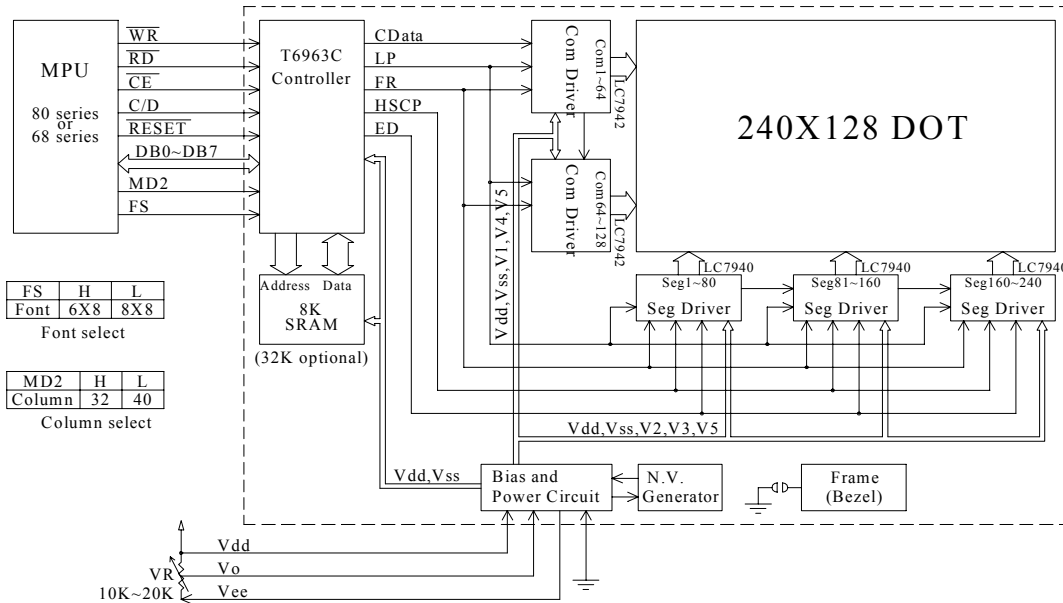

External contrast adjustment.

LED B/L drive directly
from A,K .

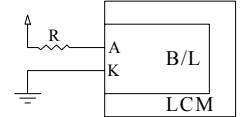

CCFL B/L drive directly
from connector .

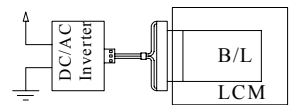

EL B/L drive directly
from A,K .

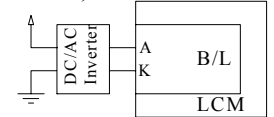

4.5 POWER SUPPLY CIRCUIT

Internal LCD V₀ Adjustment

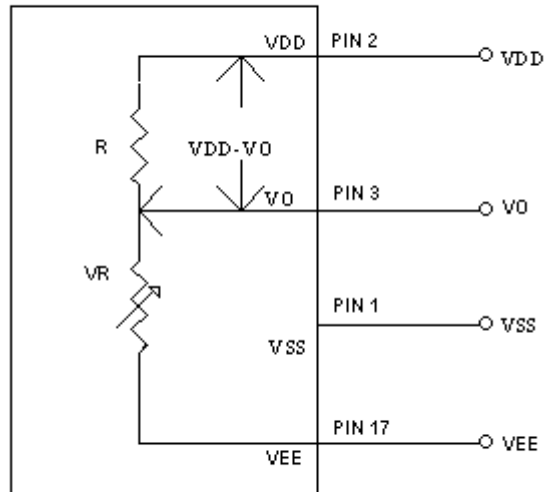

4.6 DISPLAY CONTROL INSTRUCTION

The LCD Module has built in a T6963C LSI controller, It has an 8-bit parallel data bus and control lines for writing or reading through an MPU interface, it has a 128-word character generator ROM (refer to Table 1.), which can control an external display RAM of up to 8K bytes. Allocation of text, graphics and external character generator RAM can be made easily and the display window can be moved freely within the allocated memory range.

•RAM Interface

The external RAM is used to store display data(text, graphic and external CG data). It can be freely allocated to the memory area(8 Kbyte max).

Recommend

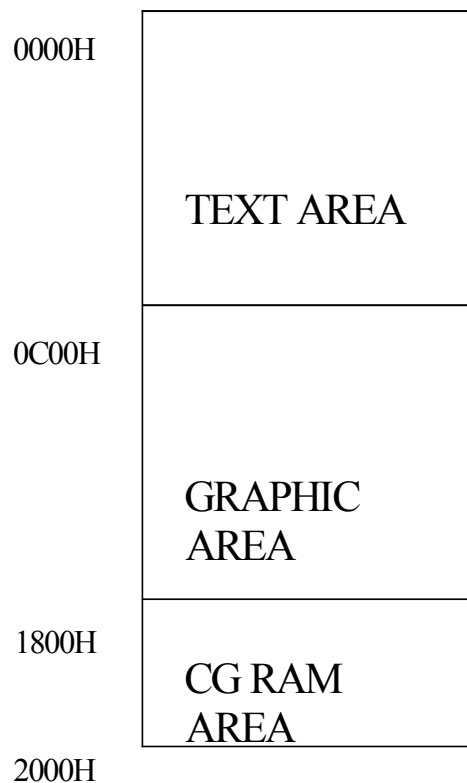

□Flowchart of communications with MPU

(1)Status Read

A status check must be performed before data is read or written.

Status check

The Status of T6963C can be read from the data lines.

- $\overline{\text{RD}}$ L
- $\overline{\text{WR}}$ H
- $\overline{\text{CE}}$ L
- C/D H
- Do to D7 H

The T6963C status word format is as follows:

MSB

LSB

STA7	STA6	STA5	STA4	STA3	STA2	STA1	STA0
D7	D6	D5	D4	D3	D2	D1	D0

STA0	Check command execution capability	0:Disable 1:Enable
STA1	Check data read/write Capability	0:Disable 1:Enable
STA2	Check Auto mode data read capability	0:Disable 1:Enable
STA3	Check Auto mode data write capability	0:Disable 1:Enable
STA4	Not used	
STA5	Check controller operation capability	0:Disable 1:Enable
STA6	Error flag. Used for Screen Peek and Screen copy commands.	0:No error 1:Error
STA7	Check the blink condition	0:Disable off 1:Normal display

(Note 1) It is necessary to check STA0 and STA1 at the same time.

There is a possibility of erroneous operation due to a hardware interrupt.

(Note 2) For most modes STA0/STA1 are used as a status check.

(Note 3) STA2 and STA3 are valid in Auto mode; STA0 and STA1 are invalid.

Status Checking flow

- (a)
- (b)

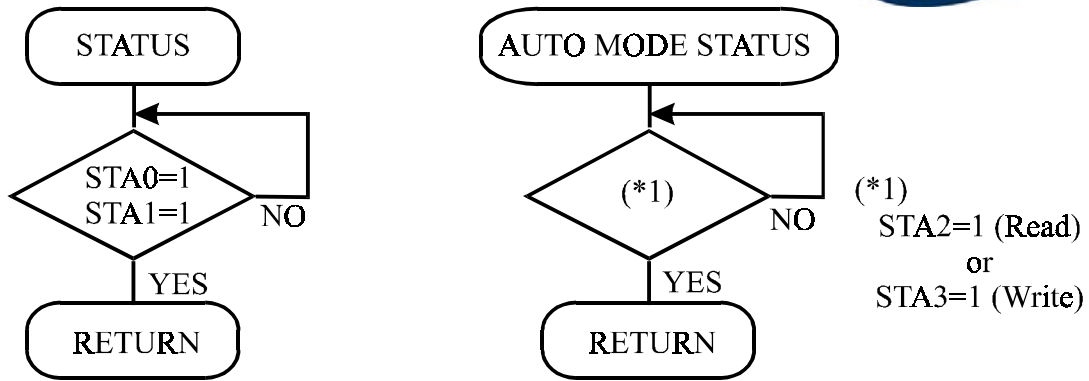

(Note 4) When using the MSB=0 command, a Status Read must be performed.

If a status check is not carried out, the T6963C cannot operate normally, even after a delay time.

The hardware interrupt occurs during the address calculation period (at the end of each line).

If a MSB=0 command is sent to the T6963C during this period, the T6963C enters Wait status.

If a status check is not carried out in this state before the next command is sent, there is the possibility that the command or data date will not be received.

(2)Setting date

When using the T6963C, first set the data, then set the command.

Procedure for sending a command

(a)The case of 1 date

(b)The case of 2 data

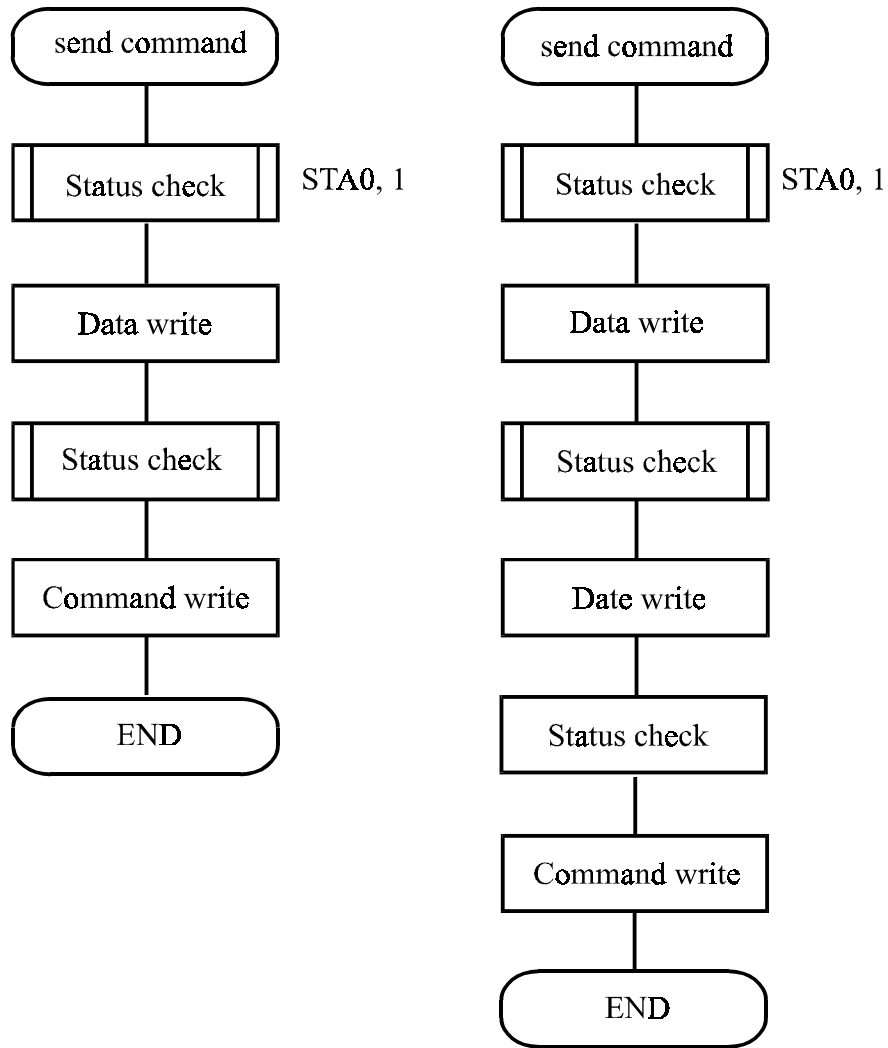

(Note) When sending more than two data, the last datum (or last two data)is valid.

□COMMAND DEFINITIONS

COMMAND	CODE	D1	D2	FUNCTION
REGISTERS SETTING	00100001	X address	Y address	Set Cursor Pointer
	00100010	Date	00H	Set Offset Register
	00100100	Low address	High address	Set Address Pointer
SET CONTROL WORD	01000000	Low address	High address	Set Text Home Address
	01000001	Columns	00H	Set Text Area
	01000010	Low address	High address	Set Graphic Home Address
	01000011	Columns	00H	Set Graphic Area
MODE SET	1000×000	—	—	OR mode
	1000×001	—	—	EXOR mode
	1000×011	—	—	AND mode
	1000×100	—	—	Text Attribute mode
	10000×××	—	—	Internal CG ROM mode
	10001×××	—	—	External CG RAM mode
DISPLAY MODE	10010000	—	—	Display off
	1001××10	—	—	Cursor on, blink off
	10001××11	—	—	Cursor on, blink on
	100101××	—	—	Text on, graphic off
	100110××	—	—	Text off, graphic on
	100111××	—	—	Text on, graphic on
CURSOR PATTERN SELECT	10100000	—	—	1-line cursor
	10100001	—	—	2-line cursor
	10100010	—	—	3-line cursor
	10100011	—	—	4-line cursor
	10100100	—	—	5-line cursor
	10100101	—	—	6-line cursor
	10100110	—	—	7-line cursor
	10100111	—	—	8-line cursor
DATA AUTO READ/WRITE	10110000	—	—	Set Data Auto Write
	10110001	—	—	Set Data Auto Read
	10110010	—	—	Auto Reset
DATA READ/WRITE	11000000	Data	—	Data Write and Increment ADP
	11000001	—	—	Data Read and Increment ADP
	11000010	Data	—	Data Write and Decrement ADP
	11000011	—	—	Data Read and Decrement ADP
	11000100	Data	—	Data Write and Non-variable ADP
	11000101	—	—	Data Read and Non-variable ADP
SCREEN PEEK	11100000	—	—	Screen Peek
SCREEN COPY	11101000			Screen Copy
BIT SET/RESET	11110×××	—	—	Bit Reset
	11111×××	—	—	Bit Set
	1111×000	—	—	Bit 0 (LSB)
	11111×001	—	—	Bit 1
	11111×010	—	—	Bit 2
	11111×011	—	—	Bit 3
	11111×100	—	—	Bit 4

	11111×101	—	—	Bit 5
	11111×110	—	—	Bit 6
	11111×111	—	—	Bit 7 (MSB)

X: invalid

□ Setting registers

CODE	HEX.	FUNCTION	D1	D2
00100001	21H	SET CURSOR POINTER	X ADRS	Y ADRS
00100010	23H	SET OFFSET REGISTER	DATA	00H
00100100	24H	SET ADDRESS POINTER	LOW ADRS	HIGH ADRS

(1) Set Cursor Pointer

The position of the cursor is specified by X ADRS and Y ADRS. The cursor position can only be moved by this command. Data read/write from the MPU never changes the cursor pointer. X ADRS and Y ADRS are specified as follows.

X ADRS 00H to 4FH (lower 7 bits are valid)

Y ADRS 00H to 1FH (lower 5 bits are valid)

Single-Scan

X ADRS 00 to 4FH

Y ADRS 00H to 0FH

(2) Set Offset Register

The offset register is used to determine the external character generator RAM area.

The T6963C has a 16-bit address bus as follows.

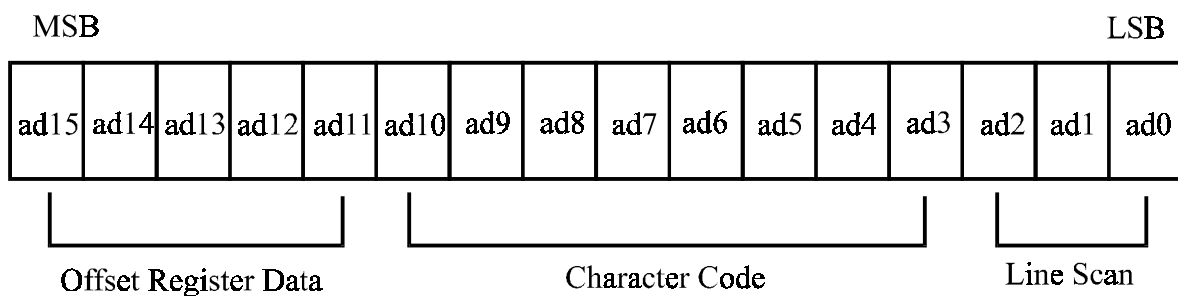

bits represent the character code of the character. In internal CG ROM, character codes 00H to 7FH represent the predefined “internal” CG ROM characters, and codes 80H to FFH represent the user’s own “external” characters. In external CG ROM mode, all 256 codes from 00H to FFH can be used to represent the user’s own characters. The three least significant bits indicate one of the eight rows of eight dots that define the character’s shape.

The relationship between display RAM address and offset register

Offset register data	CG RAM hex. address (start to end)
00000	0000 to 07 FFH
00001	0800 to 0FFFH
00010	1000 to 17FFH
11100	E000 to E7FFH
11101	E800 to EFFFH
11110	F000 to F7FFH
11111	F800 to FFFFH

(Example 1)

Offset register	02H
Character code	80H
Character generator RAM start address	0001 0100 0000 0000
	1 4 0 0 H

								(address)	(data)
								1400H	00H
			█	█	█	█		1401H	1FH
					█			1402H	04H
					█			1403H	04H
					█			1404H	04H
					█			1405H	04H
								1406H	04H
								1407H	00H

(Example 2) The relationship between display RAM data and display characters

	(RAM DATA)	(Character)
AB γ DE ζ GHIJKLM	21H	A
⋮	22H	B
⋮	83H	γ
⋮	24H	D
⋮	25H	E
	86H	ζ
Display character		

γ and ζ are displayed by character generator RAM.

(3) Set Address Pointer

The Set Address Pointer command is used to indicate the start address for writing to (or reading from) external RAM.

The Flowchart for Set Address Pointer command

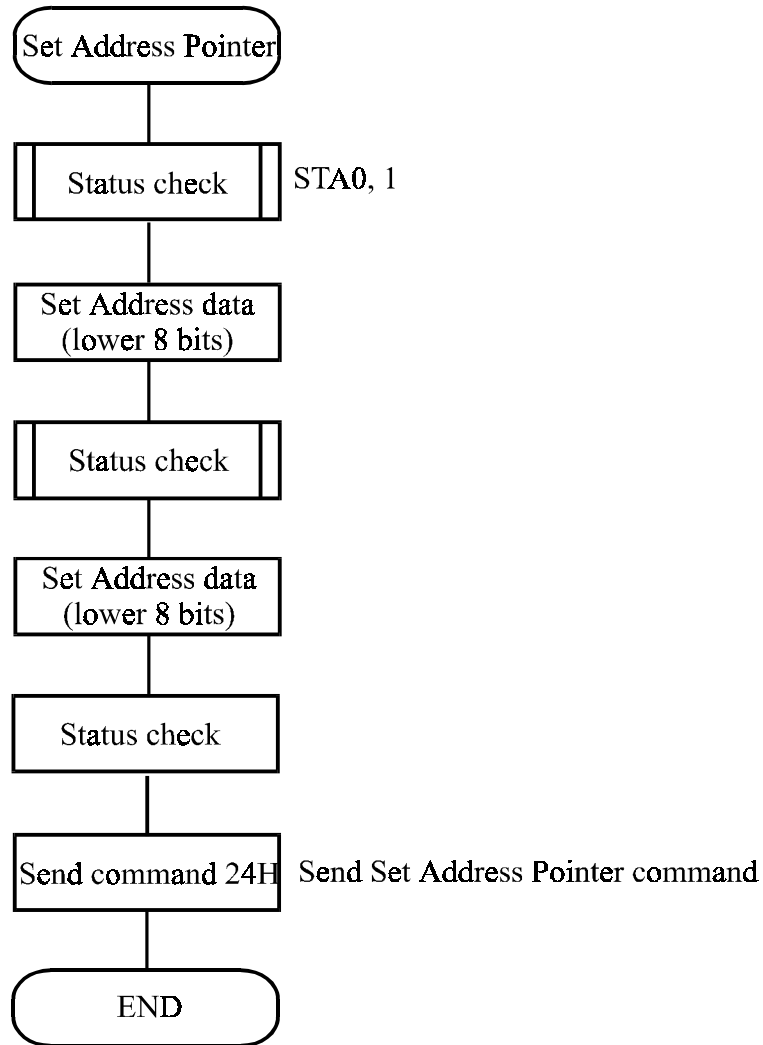

□ Set Control Word

CODE	HEX.	FUNCTION	D1	D2
01000000	40H	Set Text Home Address	Low address	High address
01000001	41H	Set Text Area	Columns	00H
01000010	42H	Set Graphic Home Address	Low address	High address
01000011	43H	Set Graphic Area	Columns	00H

The home address and column size are defined by this command.

(1) Set Text Home Address

The starting address in the external display RAM for text display is defined by this command.

The text home address indicates the leftmost and uppermost position.

The relationship between external display RAM address and display position

TH		TH+CL
TH+TA		TH+TA+CL
(TH+TA)+TA		TH+2TA+CL
(TH+2TA)+TA		TH+3TA+CL
TH+(n-1)TA		TH+(n-1)TA+CL

TH: Text home address

TA: Text area number (columns)

CL: Columns are fixed by hardware (pin-programmable).

(Example)

Text home address : 0000H
 Text area : 0020H
 : 32 Columns
 : 4 Lines

0000H	0001H		001EH	001FH
0020H	0021H		003EH	002FH
0040H	0041H		005EH	005FH
0060H	0061H		007EH	007FH

(2)Set Graphic Home Address

The starting address of the external display RAM used for graphic display is defined by this command.

The graphic home address indicates the leftmost and uppermost position.

The relationship between external display RAM address and display position

GH		GH+GL
GH+GA		GH+GA+CL
(GH+GA)+GA		GH+2GA+CL
(GH+2GA)+GA		GH+3GA+CL
GH+(n-1)GA		GH+(n-1)GA+CL

GH: Graphic home address

GA: Graphic area number (columns)

CL: Columns are fixed by hardware (pin-programmable).

(Example)

Graphic home address : 0000H
 Graphic area : 0020H
 : 32 Columns
 : 2 Lines



If the graphic area setting is set to match the desired number of columns on the LCD, the addressing scheme will be automatically modified so that the start address of each line equals the end address of the previous line +1.

□ Mode set

CODE	FUNCTION	OPERAND
1000 × 000	OR Mode	—
1000 × 001	EXOR Mode	—
1000 × 011	AND Mode	—
1000 × 100	TEXT ATTRIBUTE Mode	—
10000 × × ×	Internal Character Generator Mode	—
10001 × × ×	External Character Generator Mode	—

X: invalid

The display mode is defined by this command. The display mode does not change until the next command is sent. The logical OR, EXOR, AND of text or graphic display can be displayed. In Internal Character Generator mode, character codes 00H to 7FH are assigned to the built-in character generator ROM. The character codes 80H to FFH are automatically assigned to the external character generator RAM.

(Example)

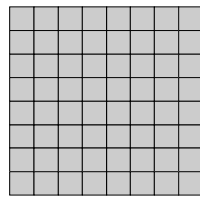

GRAPHIC

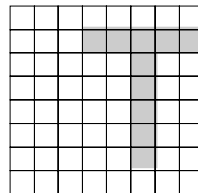

TEXT

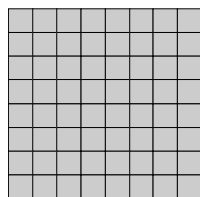

“OR”

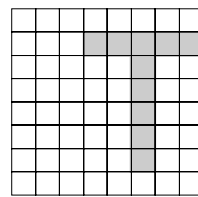

“AND”

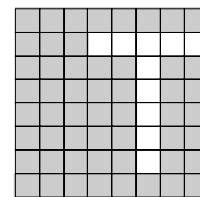

“TXOR”

(Note) Attribute functions can only be applied to text display, since the attribute data is placed in the graphic RAM area.

Attribute function

The attribute operations are Reverse display, Character blink and Inhibit. The attribute data is written into the graphic area which was defined by the Set Control Word command. Only text display is possible in Attribute Function mode; graphic display is automatically disabled. However, the Display Mode command must be used to turn both Text and Graphic on in order for the Attribute function to be available.

The attribute data for each character in the text area is written to the same address in the graphic area. The Attribute function is defined as follows.

Attribute RAM 1byte

×	×	×	×	d3	d2	d1	d0
---	---	---	---	----	----	----	----

d3	d2	d1	d0	FUNCTION
0	0	0	0	Normal display
0	1	0	1	Reverse display
0	0	1	1	Inhibit display
1	0	0	0	Blink of normal display
1	1	0	1	Blink of reverse display
1	0	1	1	Blink of inhibit display

X: invalid

□ Display mode

CODE	FUNCTION	OPERAND
10010000	Display off	—
1001××10	Cursor on, blink off	—
1001××11	Cursor on, blink on	—
100101××	Text on, graphic off	—
100110××	Text off, graphic on	—
100111××	Text on, graphic on	—

X: invalid

1	0	0	1	D3	D2	D1	D0
---	---	---	---	----	----	----	----

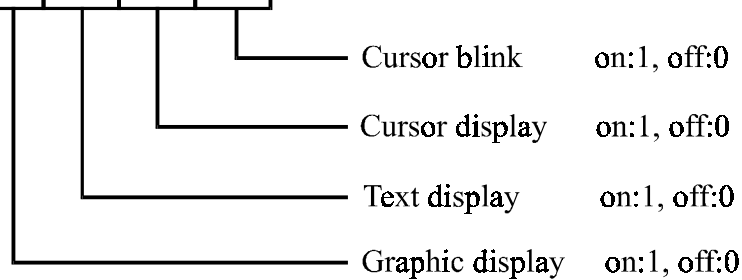

(Note)It is necessary to turn on “Text display” and “Graphic display” in the following cases.

a)Combination of text/graphic display

b)Attribute function

□ Cursor pattern select

CODE	FUNCTION	OPERAND
10100000	1-line cursor	—
10100001	2-line cursor	—

10100010	3-line cursor	—
10100011	4-line cursor	—
10100100	5-line cursor	—
10100101	6-line cursor	—
10100110	7-line cursor	—
10100111	8-line cursor	—

When cursor display is ON, this command selects the cursor pattern in the range 1 line to 8 lines.

The cursor address is defined by the Cursor Pointer Set command.

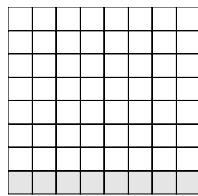

1-line cursor

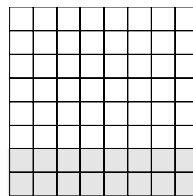

2-line cursor

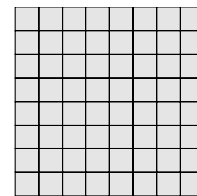

8-line cursor

□ Data Auto Read/Write

CODE	HEX.	FUNCTION	OPERAND
10110000	B0H	Set Data Auto Write	—
10110001	B1H	Set Data Auto Read	—
10110010	B2H	Auto Reset	—

The command is convenient for sending a full screen of data from the external display RAM. After setting Auto mode, a Data Write (or Read) command is need not be sent between each datum. A Data Auto Write (or Read) command must be sent after a Set Address Pointer command. After this command, the address pointer is automatically incremented by 1 after each datum. In Auto mode, the T6963C cannot accept any other commands.

The Auto Reset command must be sent to the T69963C after all data has been sent, to clear Auto mode.

(Note)A Status check for Auto mode

(STA2, STA3 should be checked between sending of each datum. Auto Reset should be performed after checking STA3=1 (STA2=1.) Refer to the following flowchart.

a) Auto Read mode

b) Auto Write mode

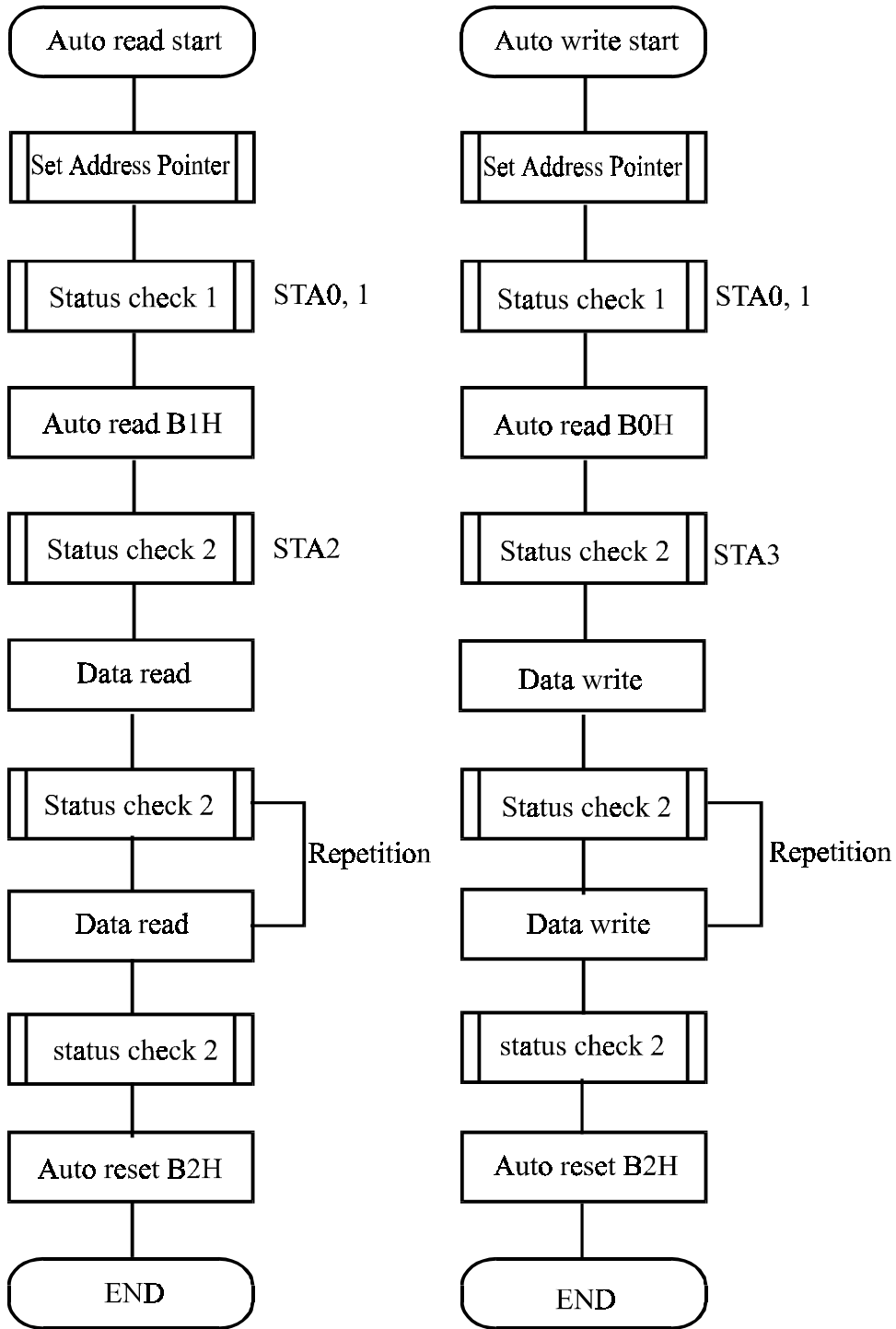

□Data Read/Write

CODE	HEX.	FUNCTION	OPERAND
11000000	C0H	Data Write and Increment ADP	Data
11000001	C1H	Data Read and Increment ADP	—
11000010	C2H	Data Write and Decrement ADP	Data
11000011	C3H	Data Read and Decrement ADP	—
11000100	C4H	Data Write and Non-variable ADP	Data
11000101	C5H	Data Read and Non-variable ADP	—

This command is used for writing data from the MPU to external display RAM, and reading data from external display RAM to the MPU. Data Write/Data Read should be executed after setting address using Set Address Pointer command. The address pointer can be automatically incremented or decremented using this command.

(Note) This command is necessary for each 1-byte datum.

Refer to the following flowchart.

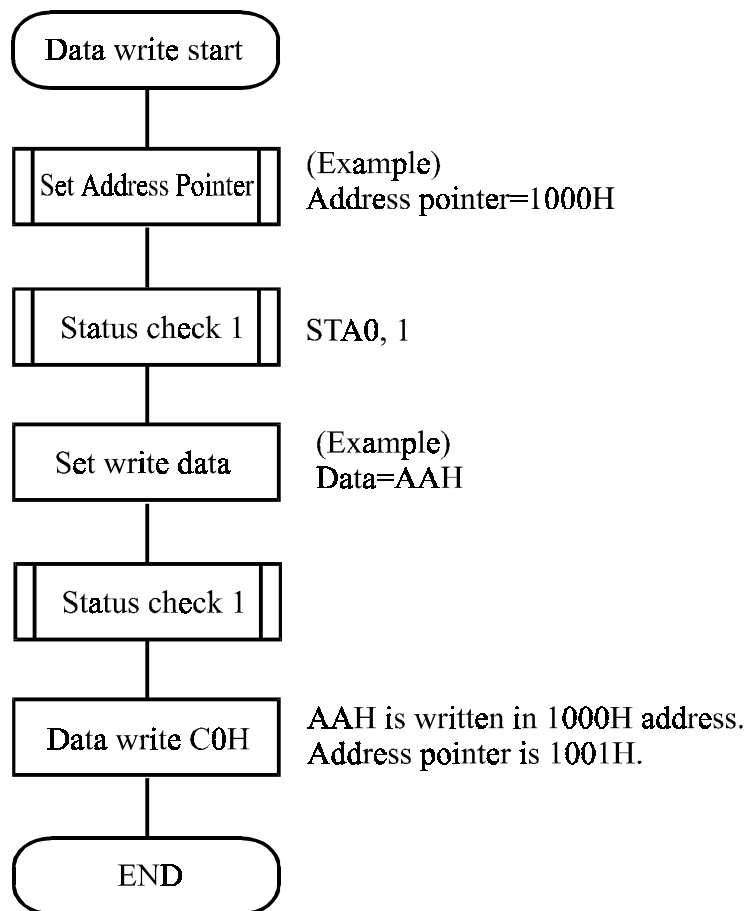

□ Screen Peek

CODE	HEX.	FUNCTION	OPERAND
11100000	E0H	Screen Peek	—e

This command is used to transfer 1 byte of displayed data to the data stack; this byte can then be read from the MPU by data access. The logical combination of text and graphic display data on the LCD screen can be read by this command.

The status (STA6) should be checked just after the Screen Peek command. If the address determined by the Set Address Pointer command is not in the graphic area, this command is ignored and a status flag (STA6) is set.

Refer to the following flowchart.

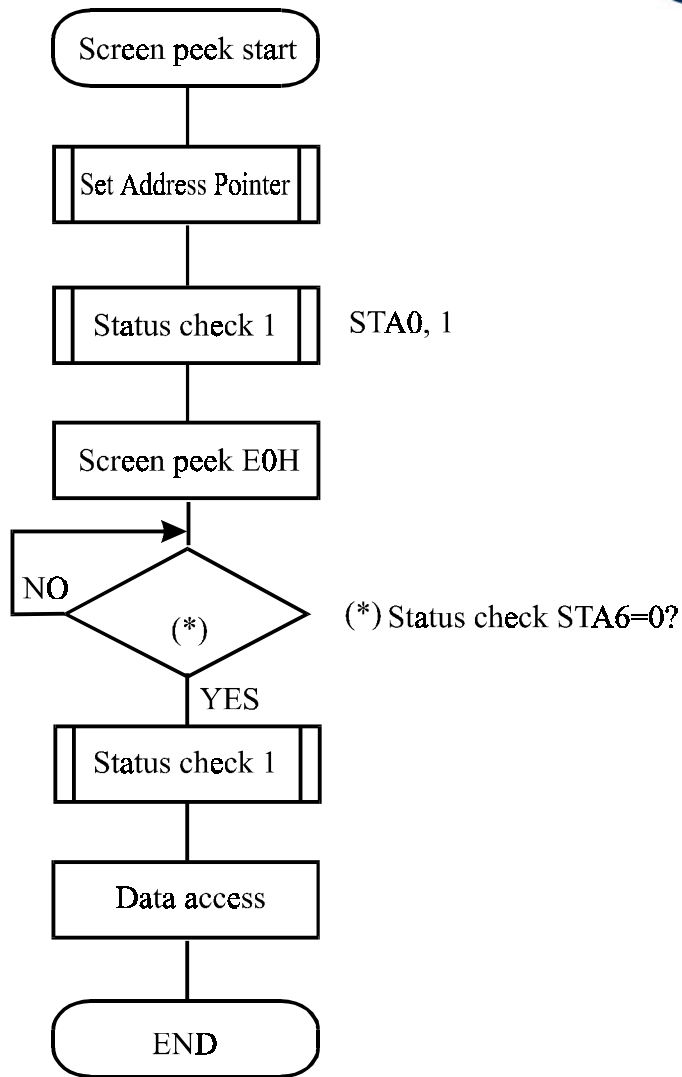

□ Screen Copy

CODE	HEX.	FUNCTION	OPERAND
11101000	E8H	Screen Copy	—

This command copies a single raster line of data to the graphic area.

The start point must be set using the Set Address Pointer command.

(Note 1) If the attribute function is being used, this command is not available.

(With Attribute data is graphic area data.)

Refer to the following flowchart.

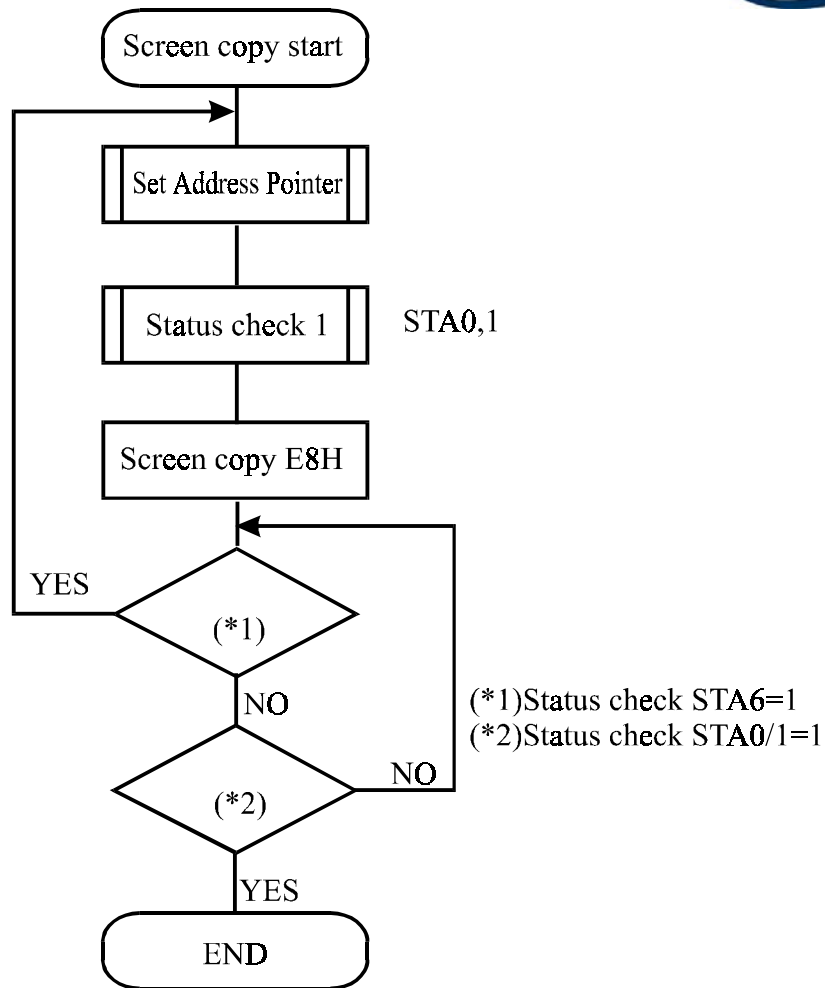

• Bit Set/Reset

CODE	FUNCTION	OPERAND
11110×××	Bit Reset	—
11111×××	Bit Set	—
1111×000	Bit 0 (LSB)	—
1111×001	Bit 1	—
1111×010	Bit 2	—
1111×011	Bit 3	—

1111 × 100	Bit 4	—
1111 × 101	Bit 5	—
1111 × 110	Bit 6	—
1111 × 111	Bit 7 (MSB)	—

X: invalid

This command use to set or reset a bit of the byte specified by the address pointer.

Only one bit can be set/reset at a time.

Refer to the following flowchart.

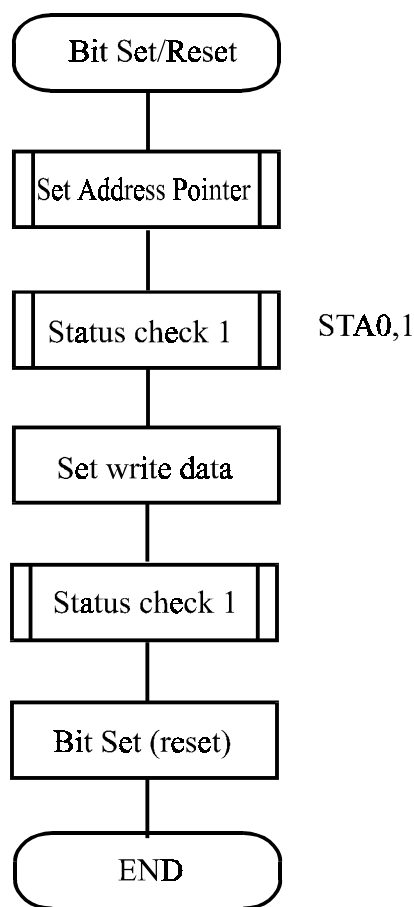

4.7 CHARACTER ROM MAP

Upper 4 bit Lower 4 bit	LLLL	LLH	LLHL	LLHH	LHLL	LHLH	LHHL	LHHH
LLLL		0	1	2	3	4	5	6
LLH	7	8	9	A	b	c	d	e
LLHL	f	z	z	z	r	r	z	z
LLHH	w	3	C	S	e	w	z	z
LHLL	4	4	O	T	t	t	z	z
LHLH	5	5	E	U	w	w	z	z
LHHL	6	6	F	U	w	w	z	z
LHHH	7	7	G	U	w	w	z	z
HLLL	C	e	e	X	X	X	z	z
HLLH	8	9	I	Y	i	w	z	z
HLHL	9	z	J	Z	z	z	z	z
HLHH	z	z	K	C	K	C	z	z
HHLL	z	z	L	L	l	l	z	z
HLLH	z	z	M	J	m	J	z	z
HHHL	z	z	N	N	n	N	z	z
HHHH	z	z	O	O	o	o	z	z

4.8 TIMING CHARACTERISTICS

Item	Symbol	Min	Typ	Max	Unit
C/D Set-up Time	t _{CDS}	100	—	—	ns
C/D Hold Time	t _{CDH}	10	—	—	ns
CE,RD,WR Pulse Width	t _{CDS} ,t _{RD} ,t _{WR}	80	—	—	ns
Data Set-up Time	t _{DS}	80	—	—	ns
Data Hold Time	t _{DH}	40	—	—	ns
Access Time	t _{ACC}	—	—	150	ns
Output Hold Time	t _{OH}	10	—	50	ns

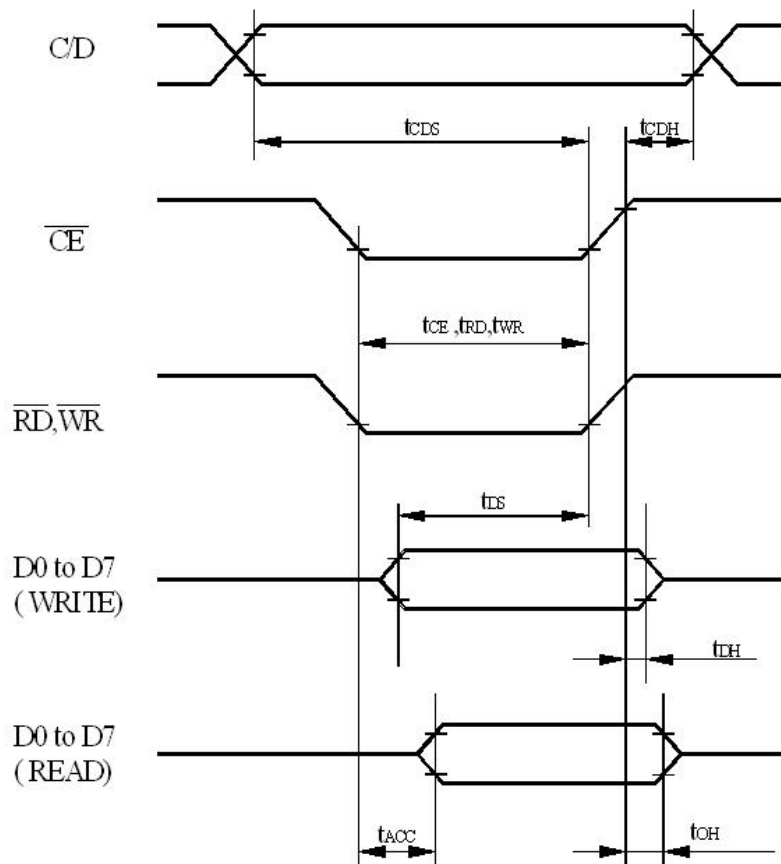

5 OPTICAL SPECIFICATION

Ta = 25 °C

Item	Symbol	Condition	Min	Typ	Max	Unit	Note
Viewing Angle in STN	θ_1	CR \geq 2	-	40	-	deg	1
	θ_2	CR \geq 2	-	20	-	deg	1
	θ_3	CR \geq 2	-	30	-	deg	2
	θ_4	CR \geq 2	-	30	-	deg	2
Viewing Angle in FSTN	θ_1	CR \geq 2	-	60	-	deg	1
	θ_2	CR \geq 2	-	30	-	deg	1
	θ_3	CR \geq 2	-	45	-	deg	2
	θ_4	CR \geq 2	-	45	-	deg	2
Contrast Ratio	CR	Ta = 25 °C	-	5	-	-	3
Response Time	Tr	Ta = 25 °C	-	200	300	ms	4
	Tf	Ta = 25 °C	-	150	250		
Driving Method	Duty	1/128					
Viewing Direction	6 O'CLOCK						

Note 1: definition of viewing angle θ_1 & θ_2

Note 2: definition of viewing angle θ_3 & θ_4

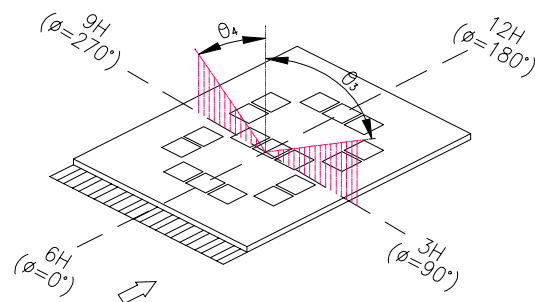
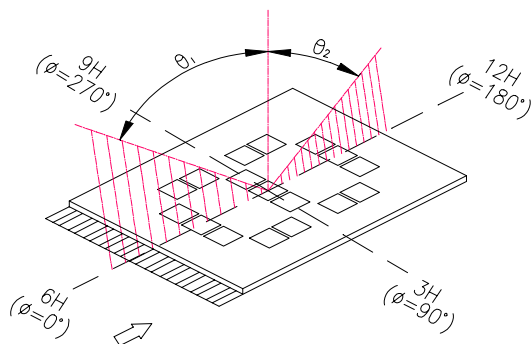

Note 3: definition of contrast ratio (CR)

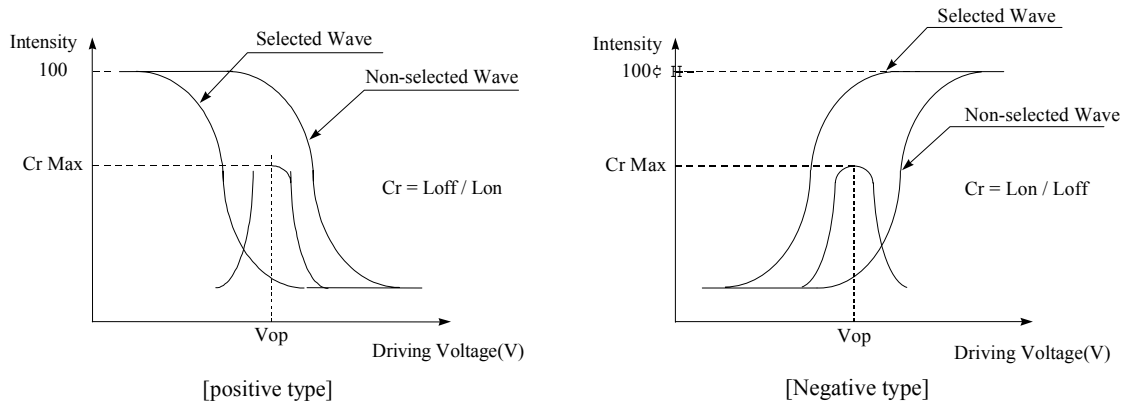

Note 4: definition of response time

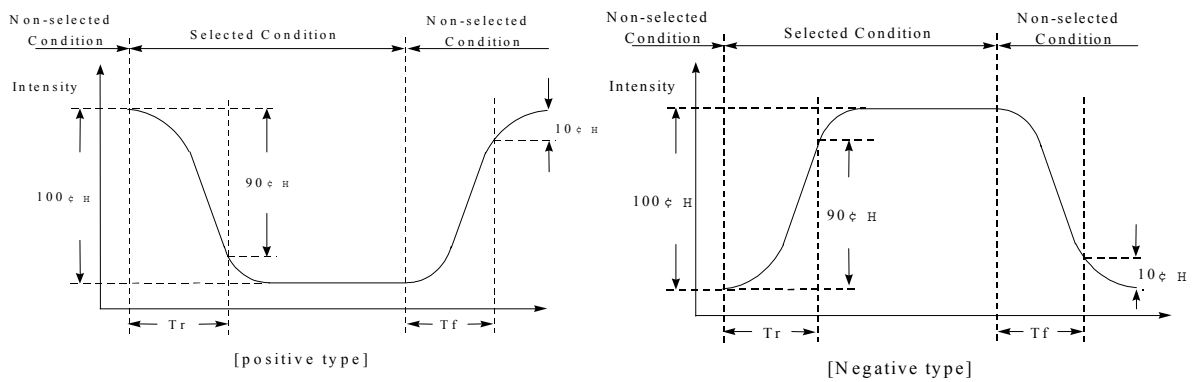

6 TOUCH SCREEN SPECIFICATION

6.1 TOUCH SCREEN ELECTRICAL CHARACTERISTICS

Item	Specification	Condition
ON Resistance	250 to 750 ohms	X Axis
	250 to 800 ohms	Y Axis
Insulation Resistance	More than 20Mohms	DC 25V
Chattering Time	Less than 10ms	100Kohms Pull-Up
Linearity	+/- 1,0%	X Axis
	+/- 1,0%	Y Axis

6.2 TOUCH SCREEN MECHANICAL CHARACTERISTICS

Item	Specification	Condition
Operating Force	Less than 80g	R8.0 HS 40 ° Silicon Rubber Or R0.8 Polyacetal Pen
Surface Hardness	More than 2H	Pencil Test
Light Transmission	More than 80%	@ 550 nm HITACHI U3300
Durability for Pen Selection	More than 1 200 000 times	Force : 250g Speed : 2cm / s

6.3 TOUCH SCREEN MECHANICAL DRAWING

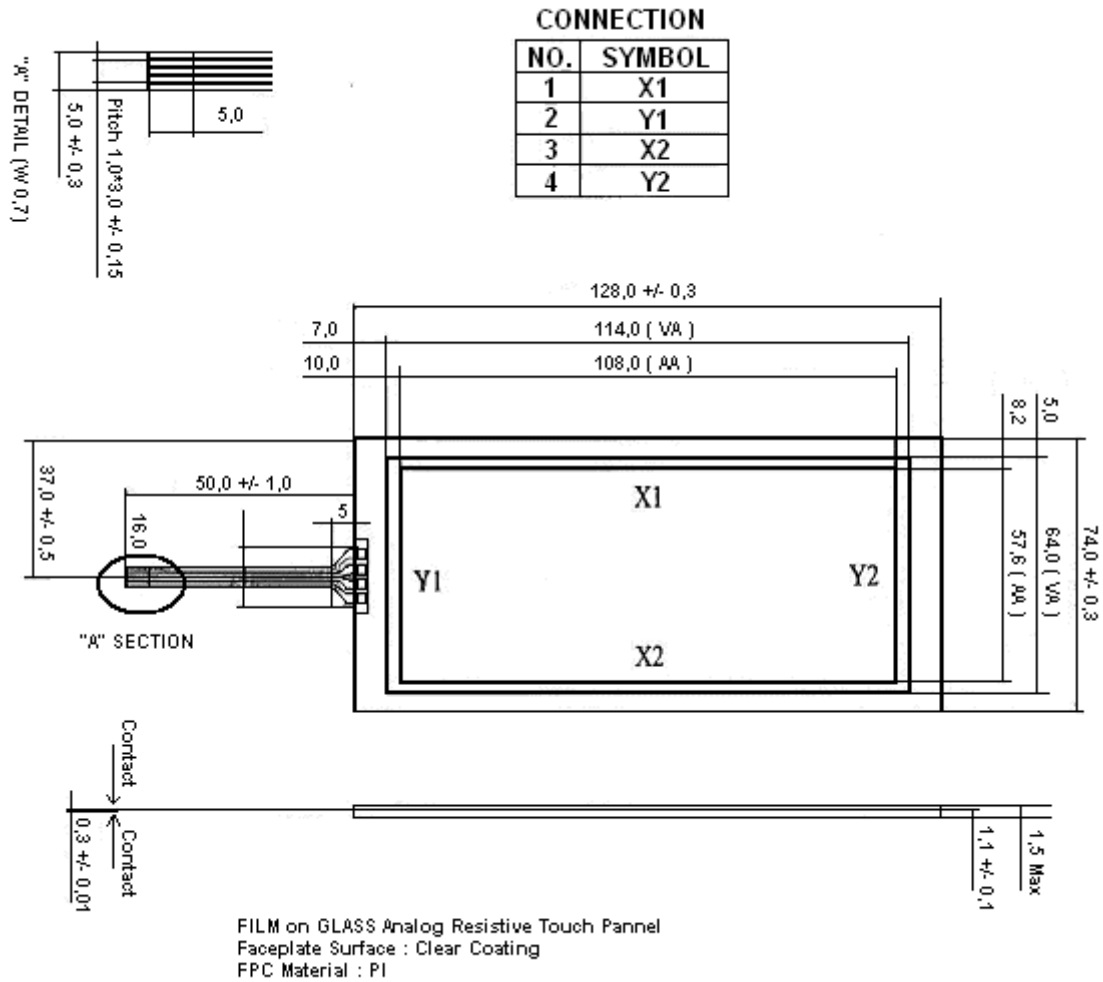

7 BACKLIGHT SPECIFICATION

7.1 LED BACKLIGHT CHARACTERISTICS

7.1.1 WHITE EDGE STANDARD LED BACKLIGHT CHARACTERISTICS

Item	Symbol	Condition	Min	Typ	Max	Unit
Supply Current	I	V = 3,5V	-	180	-	mA
Forward Voltage	V _F	I _F = 180mA	-	3,5	-	V
Reverse Voltage	V _R		-	-	8	V
Luminous Intensity before through LCD	I _V	I _F = 180mA	-	180	-	cd/m ²
Life time		I _F = 180mA	-	50K	-	hrs
Colour	WHITE					

7.1.2 YELLOW GREEN STANDARD LED BACKLIGHT CHARACTERISTICS

Item	Symbol	Condition	Min	Typ	Max	Unit
Supply Current	I	V = 4.2V	-	900	1800	mA
Forward Voltage	V _F	I _F = 900mA	-	4,2	4,6	V
Reverse Voltage	V _R		-	-	8	V
Luminous Intensity	I _V	I _F = 900mA	160	200	-	cd/m ²
LED Peak Emission Wavelength	λ _p	I _F = 900mA	-	570	-	nm
Life time		V _F ≤ 4,6V	-	100K	-	hrs
Colour	YELLOW GREEN					

7.1.3 YELLOW GREEN EDGE LED BACKLIGHT CHARACTERISTICS

Item	Symbol	Condition	Min	Typ	Max	Unit
Supply Current	I	V = 4.2V	-	200	400	mA
Forward Voltage	V _F	I _F = 200mA	-	4,2	4,6	V
Reverse Voltage	V _R		-	-	8	V
Luminous Intensity	I _V	I _F = 200mA	80	100	-	cd/m ²
LED Peak Emission Wavelength	λ _p	I _F = 200mA	-	570	-	nm
Life time		I _F = 200mA	-	100K	-	hrs
Colour	YELLOW GREEN					

7.2 CCFL BACKLIGHT CHARACTERISTICS

Item	Symbol	Condition	Min	Typ	Max	Unit
Supply Voltage	V	I = 5mA	230	250	270	V
Starting Voltage	V _s	25°C 0°C	-	-	590 650	V
Supply Current	I		4,5	5,0	5,5	mA
Lamp Power	P	I x V	-	1,03	-	Wrms
Luminous Intensity	I _V	I = 5mA	250	-	-	cd/m ²
Chromaticity	(X) (Y)		0,307 0,329	0,308 0,330	0,309 0,331	
Life time		I _F = 5mA	-	20K	-	hrs
Colour	WHITE					

8 QUALITY ASSURANCE SPECIFICATION

8.1 CONFORMITY

The performance, function and reliability of the shipped products conform to the Product Specification.

8.2 DELIVERY ASSURANCE

8.2.1 Delivery inspection standards.

- MIL-STD-105E, general inspection level II, single sampling level;
- IPC-AA610 rev. C, class 2 electronic assemblies standard

The quality assurance levels are shown below:

Rank	Item Inspected	Defect type	AQL	Remark
Critical defect	Display	Non display	0.65%	Display malfunction
		Over current		
		Missing segment		
		Wrong viewing direction		
	Backlight OFF			
	Dimension	PCB and bezel out of specification	0.65%	Assembly failure
Major defect	Display	Incorrect operating	1.0%	
	Backlight	Flashing, dust		
		Wrong colour		
Minor defect	LCD	Black and white spot	2.5%	Appearance defect
		Black and white lines		
		Polariser scratch		
		Bubbles in polariser		
		Segment deformation, pin hole		
		Colour uniformity		
	COB	Glass chip		
		Wire bond pad exposed		
		Insufficient covering with resin (wire bond line exposed)		
	PCB	Bubble, dust on COB		
Dust, solder ball on PCB				
		Pad scratch		
Total			2.5%	

8.2.2 Zone definition

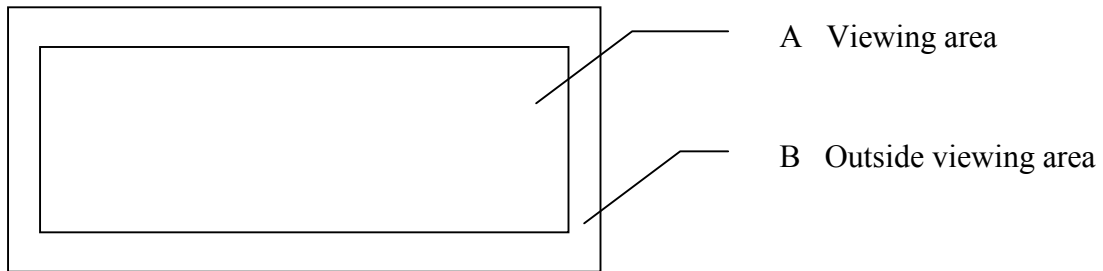

8.2.3 Visual inspection

- Inspect under 2x20W or 40W fluorescent lamp (approximately 3000 lux) leaving 25 to 30 cm between the module and the lamp and 30 cm between the module and the eye (measuring position).
- Appearance is inspected at the best contrast voltage (best contrast is adjusted considering clearness and crosstalk on screen).
- Inspect the module at 45° right and left, top and bottom.
- Use the optimum viewing angle during the contrast inspection.

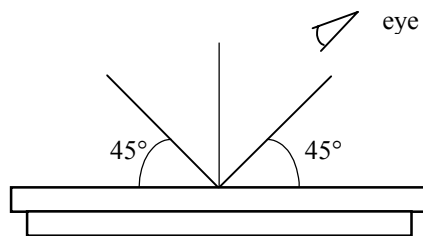

8.2.4 Standard of appearance inspection

Units: mm

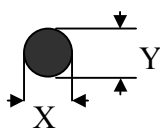
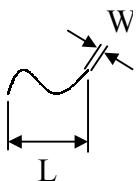
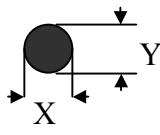
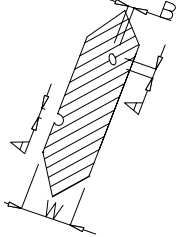
No	Item	Criteria																																			
1	Black spot, white spot, dust	<p>Round type: as per following drawing $\varnothing = (X+Y)/2$</p>  <table border="1" style="margin-left: 200px;"> <thead> <tr> <th colspan="3">Acceptable quantity</th> </tr> <tr> <th>Size</th> <th>Zone A</th> <th>Zone B</th> </tr> </thead> <tbody> <tr> <td>$\varnothing < 0.1$</td> <td>Any number</td> <td rowspan="4">Any number</td> </tr> <tr> <td>$0.1 < \varnothing < 0.2$</td> <td>6</td> </tr> <tr> <td>$0.2 < \varnothing < 0.3$</td> <td>2</td> </tr> <tr> <td>$0.3 < \varnothing$</td> <td>0</td> </tr> </tbody> </table> <p>Line type: as per following drawing</p>  <table border="1" style="margin-left: 200px;"> <thead> <tr> <th colspan="4">Acceptable quantity</th> </tr> <tr> <th>Length</th> <th>Width</th> <th>Zone A</th> <th>Zone B</th> </tr> </thead> <tbody> <tr> <td>--</td> <td>$W \leq 0.02$</td> <td>Any number</td> <td rowspan="4">Any number</td> </tr> <tr> <td>$L \leq 3.0$</td> <td>$0.02 < W \leq 0.03$</td> <td rowspan="2">2</td> </tr> <tr> <td>$L \leq 2.5$</td> <td>$0.03 < W \leq 0.05$</td> </tr> <tr> <td>--</td> <td>$0.05 < W$</td> <td>As round type</td> </tr> </tbody> </table> <p style="text-align: center;">Total acceptable quantity: 3</p>	Acceptable quantity			Size	Zone A	Zone B	$\varnothing < 0.1$	Any number	Any number	$0.1 < \varnothing < 0.2$	6	$0.2 < \varnothing < 0.3$	2	$0.3 < \varnothing$	0	Acceptable quantity				Length	Width	Zone A	Zone B	--	$W \leq 0.02$	Any number	Any number	$L \leq 3.0$	$0.02 < W \leq 0.03$	2	$L \leq 2.5$	$0.03 < W \leq 0.05$	--	$0.05 < W$	As round type
Acceptable quantity																																					
Size	Zone A	Zone B																																			
$\varnothing < 0.1$	Any number	Any number																																			
$0.1 < \varnothing < 0.2$	6																																				
$0.2 < \varnothing < 0.3$	2																																				
$0.3 < \varnothing$	0																																				
Acceptable quantity																																					
Length	Width	Zone A	Zone B																																		
--	$W \leq 0.02$	Any number	Any number																																		
$L \leq 3.0$	$0.02 < W \leq 0.03$	2																																			
$L \leq 2.5$	$0.03 < W \leq 0.05$																																				
--	$0.05 < W$	As round type																																			
2	Polariser scratch	Scratch on protective film is permitted Scratch on polariser: same as No. 1																																			
3	Polariser bubble	<p>$\varnothing = (X+Y)/2$</p>  <table border="1" style="margin-left: 200px;"> <thead> <tr> <th colspan="3">Acceptable quantity</th> </tr> <tr> <th>Size</th> <th>Zone A</th> <th>Zone B</th> </tr> </thead> <tbody> <tr> <td>$\varnothing < 0.3$</td> <td>Any number</td> <td rowspan="4">Any number</td> </tr> <tr> <td>$0.3 < \varnothing < 1.0$</td> <td>3</td> </tr> <tr> <td>$1.0 < \varnothing < 1.5$</td> <td>1</td> </tr> <tr> <td>$1.5 < \varnothing$</td> <td>0</td> </tr> </tbody> </table> <p style="text-align: center;">Total acceptable quantity: 4</p>	Acceptable quantity			Size	Zone A	Zone B	$\varnothing < 0.3$	Any number	Any number	$0.3 < \varnothing < 1.0$	3	$1.0 < \varnothing < 1.5$	1	$1.5 < \varnothing$	0																				
Acceptable quantity																																					
Size	Zone A	Zone B																																			
$\varnothing < 0.3$	Any number	Any number																																			
$0.3 < \varnothing < 1.0$	3																																				
$1.0 < \varnothing < 1.5$	1																																				
$1.5 < \varnothing$	0																																				
4	Segment deformation	<p>1.a. Pin hole on segmented display</p> <p>W: segment width $\varnothing = (A+B)/2$</p>  <table border="1" style="margin-left: 200px;"> <thead> <tr> <th colspan="2">Acceptable quantity</th> </tr> <tr> <th>Width</th> <th>\varnothing</th> </tr> </thead> <tbody> <tr> <td>$W \leq 0.4$</td> <td>$\varnothing \leq 0.2$ and $\varnothing \leq 1/2W$</td> </tr> <tr> <td>$W > 0.4$</td> <td>$\varnothing \leq 0.25$ and $\varnothing \leq 1/3W$</td> </tr> </tbody> </table> <p style="text-align: center;">Total acceptable quantity: 1 defect per segment Pin holes with \varnothing under 0.10 mm are acceptable</p>	Acceptable quantity		Width	\varnothing	$W \leq 0.4$	$\varnothing \leq 0.2$ and $\varnothing \leq 1/2W$	$W > 0.4$	$\varnothing \leq 0.25$ and $\varnothing \leq 1/3W$																											
Acceptable quantity																																					
Width	\varnothing																																				
$W \leq 0.4$	$\varnothing \leq 0.2$ and $\varnothing \leq 1/2W$																																				
$W > 0.4$	$\varnothing \leq 0.25$ and $\varnothing \leq 1/3W$																																				

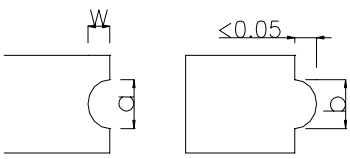
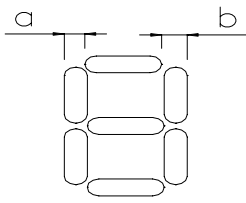
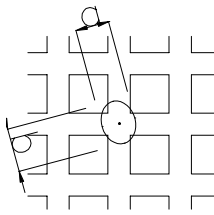
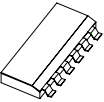
No	Item	Criteria																												
4	Segment deformation	<p>1b. Pin hole on dot matrix display</p>  <table border="1" data-bbox="997 347 1396 526"> <thead> <tr> <th colspan="2">Acceptable quantity</th> </tr> <tr> <th>Size</th> <th></th> </tr> </thead> <tbody> <tr> <td>$a, b < 0.1$</td> <td>Any number</td> </tr> <tr> <td>$(a+b)/2 \le 0.1$</td> <td>Any number</td> </tr> <tr> <td>$0.5 < \varnothing < 1.0$</td> <td>3</td> </tr> </tbody> </table> <p>Total acceptable quantity: 7</p> <p>2. Segments / dots with different width</p>  <table border="1" data-bbox="997 728 1396 840"> <thead> <tr> <th colspan="2">Acceptable</th> </tr> <tr> <th>$a \geq b$</th> <th>$a/b \leq 4/3$</th> </tr> <tr> <th>$a < b$</th> <th>$a/b > 4/3$</th> </tr> </thead> </table> <p>3. Alignment layer defect $\varnothing = (a+b)/2$</p>  <table border="1" data-bbox="997 940 1396 1164"> <thead> <tr> <th colspan="2">Acceptable quantity</th> </tr> <tr> <th>Size</th> <th></th> </tr> </thead> <tbody> <tr> <td>$\varnothing \leq 0.4$</td> <td>Any number</td> </tr> <tr> <td>$0.4 < \varnothing \leq 1.0$</td> <td>5</td> </tr> <tr> <td>$1.0 < \varnothing \leq 1.5$</td> <td>3</td> </tr> <tr> <td>$1.5 < \varnothing \leq 2.0$</td> <td>2</td> </tr> </tbody> </table> <p>Total acceptable quantity: 7</p>	Acceptable quantity		Size		$a, b < 0.1$	Any number	$(a+b)/2 \le 0.1$	Any number	$0.5 < \varnothing < 1.0$	3	Acceptable		$a \geq b$	$a/b \leq 4/3$	$a < b$	$a/b > 4/3$	Acceptable quantity		Size		$\varnothing \leq 0.4$	Any number	$0.4 < \varnothing \leq 1.0$	5	$1.0 < \varnothing \leq 1.5$	3	$1.5 < \varnothing \leq 2.0$	2
Acceptable quantity																														
Size																														
$a, b < 0.1$	Any number																													
$(a+b)/2 \le 0.1$	Any number																													
$0.5 < \varnothing < 1.0$	3																													
Acceptable																														
$a \geq b$	$a/b \leq 4/3$																													
$a < b$	$a/b > 4/3$																													
Acceptable quantity																														
Size																														
$\varnothing \leq 0.4$	Any number																													
$0.4 < \varnothing \leq 1.0$	5																													
$1.0 < \varnothing \leq 1.5$	3																													
$1.5 < \varnothing \leq 2.0$	2																													
5	Colour uniformity	Level of sample for approval set as limit sample																												
6	Backlight	<p>The backlight colour should correspond to the product specification Flashing and or unlit backlight is not allowed Dust larger than 0.25 mm is not allowed</p>																												
7	COB	<p>Exposed wire bond pad is not allowed Insufficient covering with resin is not allowed (wire bond line exposed) Dust or bubble on the resin are not allowed</p>																												
8	 PCB	<p>No unmelted solder paste should be present on PCB Cold solder joints, missing solder connections, or oxidation are not allowed No residue or solder balls on PCB are allowed Short circuits on components are not allowed</p>																												

9 RELIABILITY SPECIFICATION

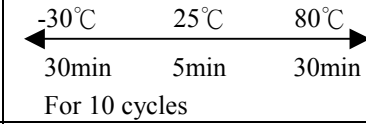
Test Item	Test Condition	Description
High Temperature Operation	50°C or 70°C 200hrs	Endurance test applying the electric stress (Voltage & Current) and the thermal stress to the element for a long time.
Low Temperature Operation	0°C or -20°C 200hrs	Endurance test applying the electric stress under low temperature for a long time.
High Temperature Storage	70°C or 80°C 200hrs	Endurance test applying the high storage temperature for a long time.
Low Temperature Storage	-20°C or -30°C 200hrs	Endurance test applying the high storage temperature for a long time.
High Temperature & High Humidity Storage	80°C, 90%RH 96hrs	Endurance test applying the high temperature and high humidity storage for a long time.
Thermal Shock Test	 <p>For 10 cycles</p>	Endurance test applying the low and high temperature cycle. Burn In Test.
Vibration	10~22Hz→1.5mmp-p 22~500Hz→1.5G Total 0.5hrs	Endurance test applying the vibration during transportation and using.
ESD	VS=800V,RS=1.5kΩ CS=100pF	Endurance test applying the electric stress to the terminal.
Shock Test	50G Half sign wave 11 msec 3 times of each direction	Constructional and mechanical endurance test applying the shock during transportation.

10 HANDLING PRECAUTIONS

Safety

If the LCD panel breaks, be careful not to get the liquid crystal fluid in your mouth or in your eyes.
If the liquid crystal touches your skin or clothes, wash it off immediately using soap and plenty of water.

Mounting and Design

Place a transparent plate (e.g. acrylic, polycarbonate or glass) on the display surface to protect the display from external pressure. Leave a small gap between the transparent plate and the display surface.
When assembling with a zebra connector, clean the surface of the pads with alcohol and keep the surrounding air very clean.
Design the system so that no input signal is given unless the power supply voltage is applied.

Caution during LCD cleaning

Lightly wipe the display surface with a soft cloth soaked with Isopropyl alcohol, Ethyl alcohol or Trichlorotrifluoroethane.
Do not wipe the display surface with dry or hard materials that will damage the polariser surface.
Do not use aromatic solvents (toluene and xylene), or ketonic solvents (ketone and acetone).

Caution against static charge

As the display uses C-MOS LSI drivers, connect any unused input terminal to VDD or VSS. Do not input any signals before power is turned on.
Also, ground your body, work/assembly table and assembly equipment to protect against static electricity.

Packaging

Displays use LCD elements, and must be treated as such. Avoid strong shock and drop from a height.
To prevent displays from degradation, do not operate or store them exposed directly to sunshine or high temperature/humidity.

Caution during operation

It is indispensable to drive the display within the specified voltage limit since excessive voltage shortens its life.
Direct current causes an electrochemical reaction with remarkable deterioration of the display quality. Give careful consideration to prevent direct current during ON/OFF timing and during operation.
Response time is extremely delayed at temperatures lower than the operating temperature range while, at high temperatures, displays become dark. However, this phenomenon is reversible and does not mean a malfunction or a display that has been permanently damaged.
If the display area is pushed on hard during operation, some graphics will be abnormally displayed but returns to a normal condition after turning off the display once.
Even a small amount of condensation on the contact pads (terminals) can cause an electro-chemical reaction which causes missing rows and columns. Give careful attention to avoid condensation.

Storage

Store the display in a dark place where the temperature is $25^{\circ}\text{C} \pm 10^{\circ}\text{C}$ and the humidity below 50%RH.
Store the display in a clean environment, free from dust, organic solvents and corrosive gases.
Do not crash, shake or jolt the display (including accessories).

X-ON Electronics

Largest Supplier of Electrical and Electronic Components

Click to view similar products for [densitron](#) manufacturer:

Other Similar products are found below :

[DMT024QVNUNT0-2C](#) [DMT028QVNTNT0S-1A](#) [DMT028QVHXCMI-1A](#) [DMT024QVNUCMI-2A](#) [LMR4048BG2C16HNG/5V](#)