

| REV. | ECN NO. | LOCATION | DESCRIPTION | DATE | DESIGN |
|------|---------|----------|--------------------------|----------|--------|
| X1 | | | INITIAL RELEASE | 23.05.15 | JACKY |
| X2 | | | Modify part number rules | 23.06.30 | JACKY |
| X3 | | | Add packaging drawings | 23.07.13 | JACKY |

A
B
C
D
E

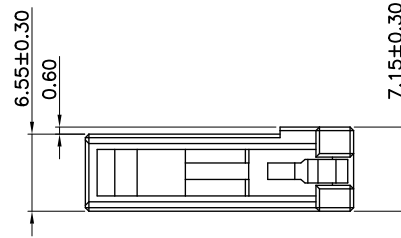
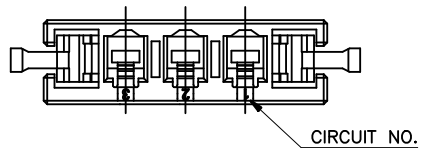
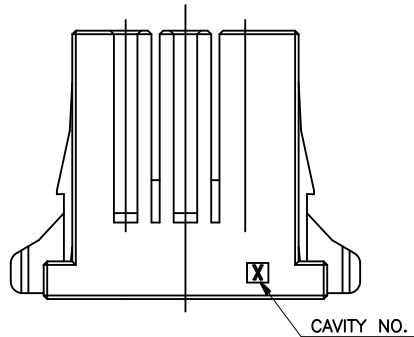
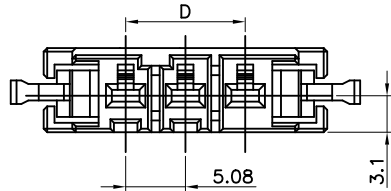
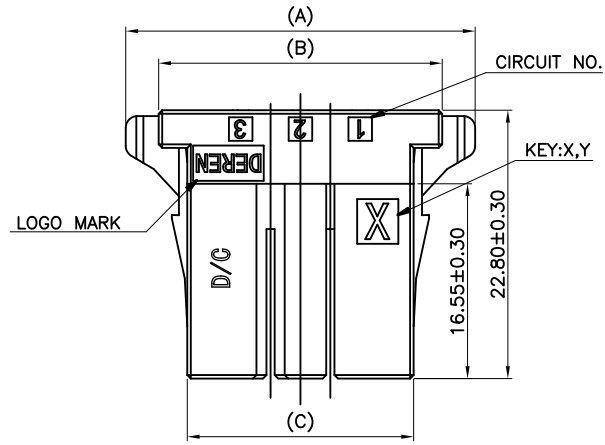

NOTES:

PRODUCT MUST MEET CONTROLLED SUBSTANCES SPEC. ROHS 2.0

1. MATERIAL: HIGH TEMPERATURE THERMOPLASTIC

2. THE SHAPE, SIZE AND POSITION OF THE CHARACTER SHOW THE OUTLINE. THEY DON'T SHOW DETAILS.

3. UNSPECIFIED TOLERANCE: X:±0.30 X:±5°
.X±0.25 .X±3°
.XX±0.20

4. PART NUMBER INFORMATION:

56**BG-***R * * * * 0000

- RESERVE NUMBER
- KEYING MARK
X: KEY X
Y: KEY Y
- PACKAGE CODE:
B: BAG PACING
- LOGO:
1: WITH DEREN LOGO
2: WITHOUT LOGO
- HOUSING COLOR:
1: BLACK
2: WHITE
- WATER CODE: 001~ZZZ
- POS CODE:
02: 2POS
03: 3POS
04: 4POS
05: 5POS
06: 6POS

| | 02 | X | 5602BG-006R***X0000 | 24.62 | 19.02 | 14.16 | 5.08 |
|-----------------|-----|--------|---------------------|-------|-------|-------|-------|
| | 02 | Y | 5602BG-006R***Y0000 | 24.62 | 19.02 | 14.16 | 5.08 |
| | 03 | X | 5603BG-006R***X0000 | 29.70 | 24.10 | 19.24 | 10.16 |
| | 03 | Y | 5603BG-006R***Y0000 | 29.70 | 24.10 | 19.24 | 10.16 |
| | 04 | X | 5604BG-012R***X0000 | 34.78 | 29.18 | 24.32 | 15.24 |
| | 04 | Y | 5604BG-012R***Y0000 | 34.78 | 29.18 | 24.32 | 15.24 |
| KEYING LOCATION | POS | KEYING | P/N | A | B | C | D |

| DIM | TOL | DIM | TOL |
|-----|-------|-----|-----|
| X. | ±0.30 | X. | ±2° |
| .X | ±0.25 | .X | ±1° |
| .XX | ±0.20 | | |

DEREN
SHENZHEN DEREN ELECTRONIC CO., LTD

| | | |
|---------------|----------|--|
| C-DWG: | DATE | TITLE: DR500 S_Wire Rec_2~6Pin Pitch5.08 HSG |
| DESIGN: JACKY | 23,07,13 | P/N: 56**BG-***R***0000 |
| CHECK: | | SHEET: 1/3 |
| APPROVAL: | | SCALE: N/A UNIT: mm |

1 2 3 4 5 6 7 8

1 2 3 4 5 6 7 8

| REV. | ECN NO. | LOCATION | DESCRIPTION | DATE | DESIGN |
|------|---------|----------|--------------------------|----------|--------|
| X1 | | | INITIAL RELEASE | 23.05.15 | JACKY |
| X2 | | | Modify part number rules | 23.06.30 | JACKY |
| X3 | | | Add packaging drawings | 23.07.13 | JACKY |

A

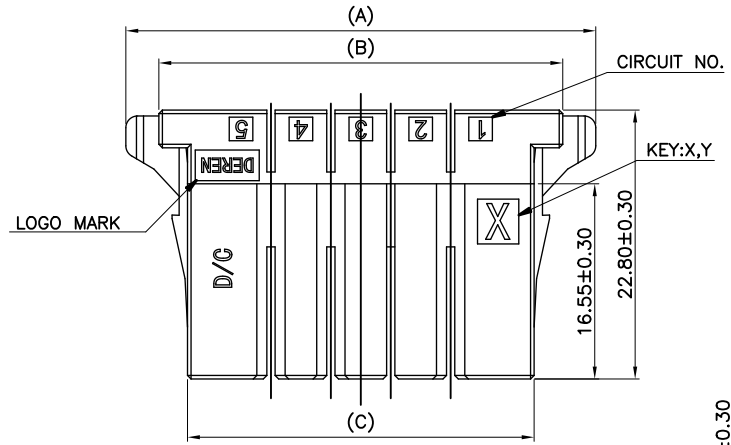

B

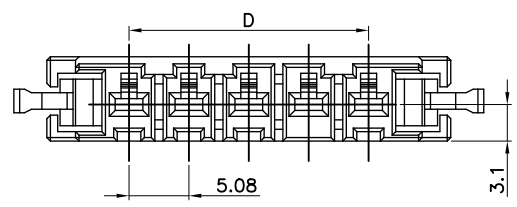

C

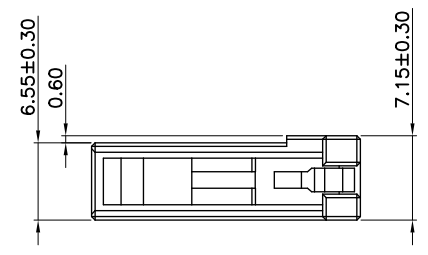

D

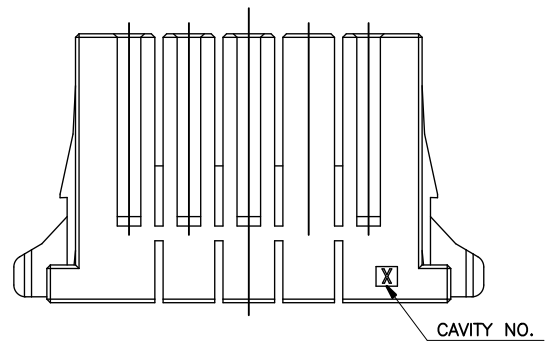

E

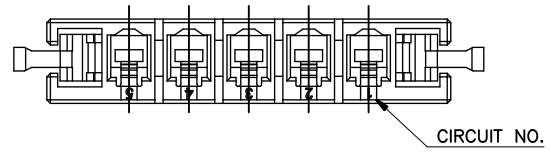

| | 05 | X | 5605BG-006R***X0000 | 39.86 | 34.26 | 29.40 | 20.32 |
|-----------------|-----|--------|---------------------|-------|-------|-------|-------|
| | 05 | Y | 5605BG-006R***Y0000 | 39.86 | 34.26 | 29.40 | 20.32 |
| | 06 | X | 5606BG-018R***X0000 | 44.94 | 39.34 | 34.48 | 25.40 |
| | 06 | Y | 5606BG-018R***Y0000 | 44.94 | 39.34 | 34.48 | 25.40 |
| KEYING LOCATION | POS | KEYING | P/N | A | B | C | D |

| DIM | TOL | DIM | TOL | DEREN | | | |
|-----|-------|-----|-----|------------------------------------|---------------|----------|--|
| X. | ±0.30 | X. | ±2° | SHENZHEN DEREN ELECTRONIC CO., LTD | | | |
| .X | ±0.25 | .X | ±1° | | | | |
| .XX | ±0.20 | | | DRAW NO. SC2309327-1 | C-DWG: | DATE | TITLE: DR500 S_Wire Rec_2~6Pin Pitch5.08 HSG |
| | | | | | DESIGN: JACKY | 23,07,13 | P/N: 56**BG-***R****0000 |
| | | | | REV. X3 | CHECK: | | SHEET: 2/3 |
| | | | | APPROVAL: | | | UNIT: mm |

1 2 3 4 5 6 7 8

1 2 3 4 5 6 7 8

| REV. | ECN NO. | LOCATION | DESCRIPTION | DATE | DESIGN |
|------|---------|----------|--------------------------|----------|--------|
| X1 | | | INITIAL RELEASE | 23.05.15 | JACKY |
| X2 | | | Modify part number rules | 23.06.30 | JACKY |
| X3 | | | Add packaging drawings | 23.07.13 | JACKY |

A

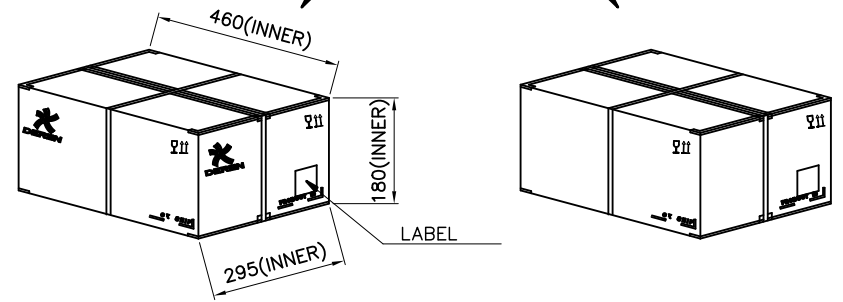
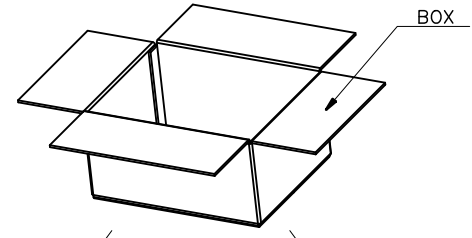
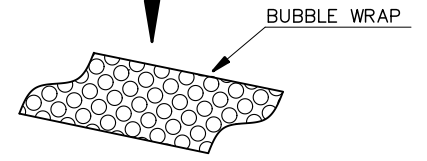
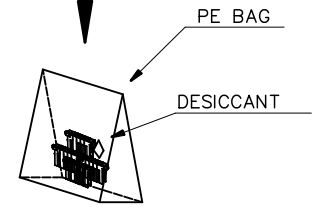
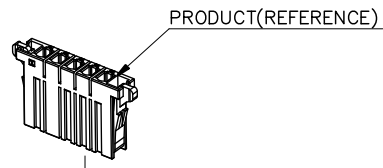

B

C

D

E

PACKAGE QUANTITY:

| PART NO. | POS | PCS/BAG | BAG/BOX | PCS/BOX |
|---------------------|-----|---------|---------|---------|
| 5602BG-006R**B*0000 | 2 | 320 | 6 | 1920 |
| 5603BG-006R**B*0000 | 3 | 290 | 6 | 1740 |
| 5604BG-012R**B*0000 | 4 | 260 | 6 | 1560 |
| 5605BG-006R**B*0000 | 5 | 230 | 6 | 1380 |
| 5606BG-018R**B*0000 | 6 | 200 | 6 | 1200 |

| DIM | TOL | DIM | TOL |  DEREN SHENZHEN DEREN ELECTRONIC CO., LTD |
|-----|-------|-----|-----|--|
| X. | ±0.30 | X. | ±2° | |
| .X | ±0.25 | .X | ±1° | |
| .XX | ±0.20 | | | |
| | | | | C-DWG: DATE: 23,07,13 TITLE: DR500 S_Wire Rec_2~6Pin Pitch5.08 HSG P/N: 56**BG-***R****0000 |
| | | | | DRAW NO. SC2309327-1 DESIGN: JACKY CHECK: APPROVAL: |
| | | | | SHEET: 1/3 SCALE: N/A UNIT: mm |

1 2 3 4 5 6 7 8

X-ON Electronics

Largest Supplier of Electrical and Electronic Components

Click to view similar products for [Headers & Wire Housings](#) category:

Click to view products by [DEREN](#) manufacturer:

Other Similar products are found below :

[0015917161](#) [0022155065](#) [57102-F02-18ULF](#) [58102-G61-06LF](#) [582553-1](#) [01.001.5753.1](#) [0050291907](#) [02.125.8002.8](#) [609-3404](#) [61062-3](#)
[CSU011177004](#) [622-0430](#) [622-3653LF](#) [63453-116](#) [636-1030](#) [636-1427](#) [636-3427](#) [636-4007](#) [641938-9](#) [65495-038](#) [65692-001LF](#) [65781-018](#)
[65781-047](#) [65817-010LF](#) [65817-015LF](#) [67095-007LF](#) [67601157](#) [68631-112](#) [699319-000](#) [70.362.1628.0](#) [70-4210](#) [70-4226B](#) [70-4853B](#) [707-](#)
[5028](#) [71.350.2428.0](#) [733-134](#) [733-162](#) [760-3052](#) [MHR-64-VUAL](#) [80.063.4001.1](#) [800-90-001-10-001000](#) [801-43-002-10-013000](#)
[801-43-006-10-002000](#) [803-43-024-10-001000](#) [803-93-012-10-001000](#) [8-1437020-4](#) [819-22-004-30-001101](#) [820-22-006-30-001101](#)
[820-22-008-30-001101](#) [821-22-002-10-001101](#)