

REV.	ECN NO.	LOCATION	DESCRIPTION	DATE	DESIGN
X1			INITIAL RELEASE	23.05.15	JACKY
X2			Modify part number rules	23.06.30	JACKY
X3			Add packaging drawings	23.07.13	JACKY

A
B
C
D
E

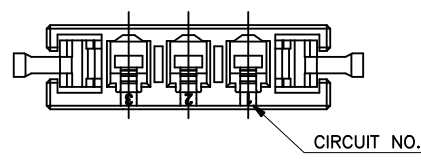
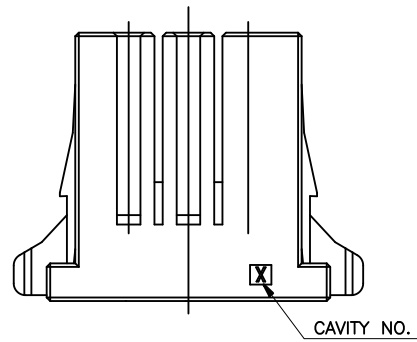
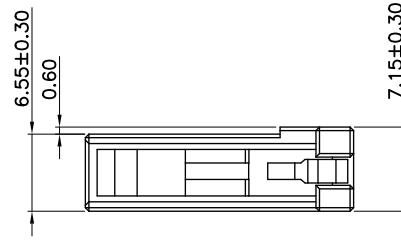
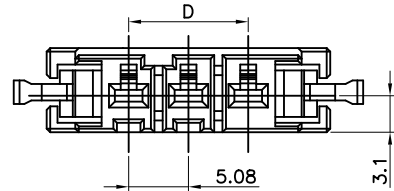
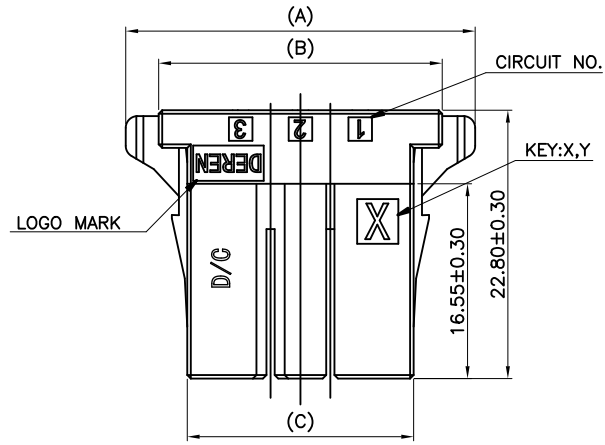

NOTES:

PRODUCT MUST MEET CONTROLLED SUBSTANCES SPEC. ROHS 2.0

1. MATERIAL: HIGH TEMPERATURE THERMOPLASTIC

2. THE SHAPE, SIZE AND POSITION OF THE CHARACTER SHOW THE OUTLINE. THEY DON'T SHOW DETAILS.

3. UNSPECIFIED TOLERANCE: X:±0.30 X:±5°
.X±0.25 .X±3°
.XX±0.20

4. PART NUMBER INFORMATION:

56**BG-***R * * * * 0000

- RESERVE NUMBER
- KEYING MARK
X: KEY X
Y: KEY Y
- PACKAGE CODE:
B: BAG PACING
- LOGO:
1: WITH DEREN LOGO
2: WITHOUT LOGO
- HOUSING COLOR:
1: BLACK
2: WHITE
- WATER CODE: 001~ZZZ
- POS CODE:
02: 2POS
03: 3POS
04: 4POS
05: 5POS
06: 6POS

	02	X	5602BG-006R***X0000	24.62	19.02	14.16	5.08
	02	Y	5602BG-006R***Y0000	24.62	19.02	14.16	5.08
	03	X	5603BG-006R***X0000	29.70	24.10	19.24	10.16
	03	Y	5603BG-006R***Y0000	29.70	24.10	19.24	10.16
	04	X	5604BG-012R***X0000	34.78	29.18	24.32	15.24
	04	Y	5604BG-012R***Y0000	34.78	29.18	24.32	15.24
KEYING LOCATION	POS	KEYING	P/N	A	B	C	D

DIM	TOL	DIM	TOL
X.	±0.30	X.	±2°
.X	±0.25	.X	±1°
.XX	±0.20		

DEREN
SHENZHEN DEREN ELECTRONIC CO., LTD

C-DWG:	DATE	TITLE: DR500 S_Wire Rec_2~6Pin Pitch5.08 HSG
DESIGN: JACKY	23,07,13	P/N: 56**BG-***R***0000
CHECK:		SHEET: 1/3
APPROVAL:		SCALE: N/A UNIT: mm

1 2 3 4 5 6 7 8

1 2 3 4 5 6 7 8

REV.	ECN NO.	LOCATION	DESCRIPTION	DATE	DESIGN
X1			INITIAL RELEASE	23.05.15	JACKY
X2			Modify part number rules	23.06.30	JACKY
X3			Add packaging drawings	23.07.13	JACKY

A

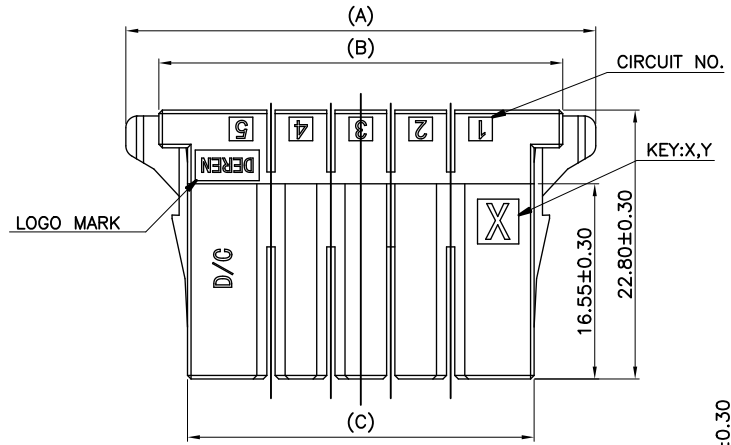

B

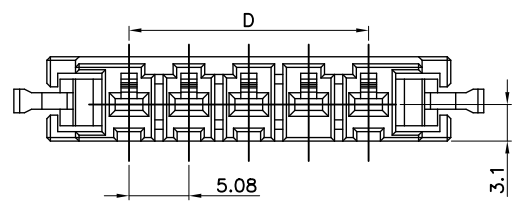

D

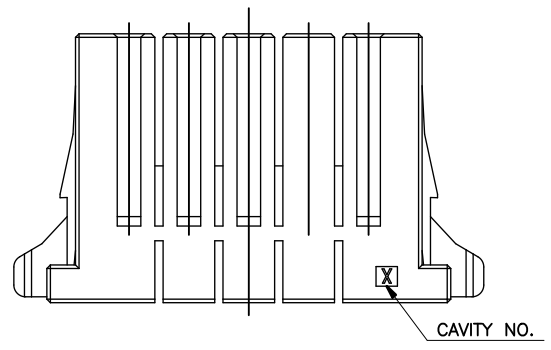

E

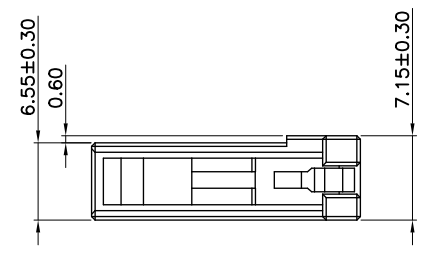
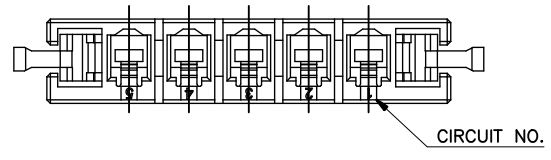

	05	X	5605BG-006R***X0000	39.86	34.26	29.40	20.32
	05	Y	5605BG-006R***Y0000	39.86	34.26	29.40	20.32
	06	X	5606BG-018R***X0000	44.94	39.34	34.48	25.40
	06	Y	5606BG-018R***Y0000	44.94	39.34	34.48	25.40
KEYING LOCATION	POS	KEYING	P/N	A	B	C	D

DIM	TOL	DIM	TOL	DEREN			
X.	±0.30	X.	±2°	SHENZHEN DEREN ELECTRONIC CO., LTD			
.X	±0.25	.X	±1°		C-DWG:	DATE	TITLE: DR500 S_Wire Rec_2~6Pin Pitch5.08 HSG
.XX	±0.20				DRAW NO.	DESIGN: JACKY	23,07,13
				SC2309327-1	CHECK:		SHEET: 2/3
		REV.	X3	APPROVAL:			SCALE: N/A UNIT: mm

1 2 3 4 5 6 7 8

1 2 3 4 5 6 7 8

REV.	ECN NO.	LOCATION	DESCRIPTION	DATE	DESIGN
X1			INITIAL RELEASE	23.05.15	JACKY
X2			Modify part number rules	23.06.30	JACKY
X3			Add packaging drawings	23.07.13	JACKY

A

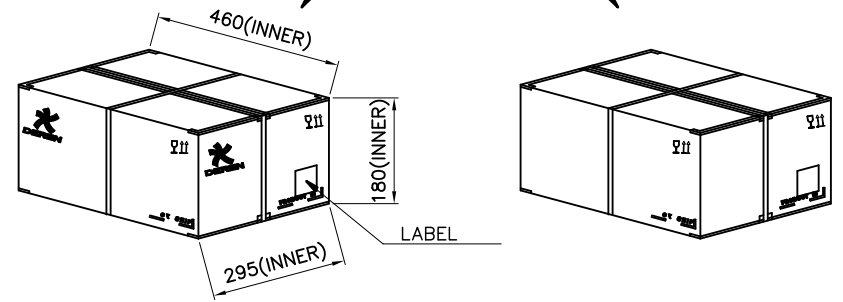
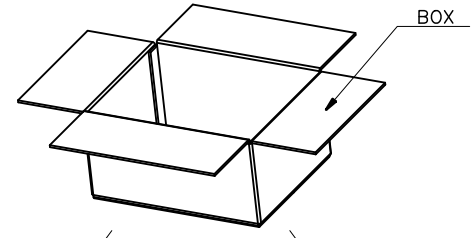
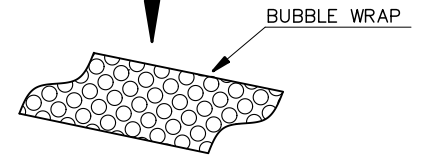
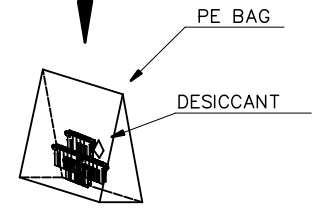
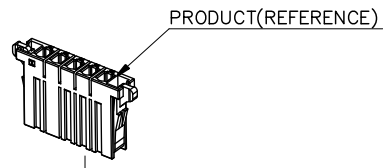

B

C

D

E

PACKAGE QUANTITY:

PART NO.	POS	PCS/BAG	BAG/BOX	PCS/BOX
5602BG-006R**B*0000	2	320	6	1920
5603BG-006R**B*0000	3	290	6	1740
5604BG-012R**B*0000	4	260	6	1560
5605BG-006R**B*0000	5	230	6	1380
5606BG-018R**B*0000	6	200	6	1200

DIM	TOL	DIM	TOL	 DEREN SHENZHEN DEREN ELECTRONIC CO., LTD
X.	±0.30	X.	±2°	
.X	±0.25	.X	±1°	
.XX	±0.20			
				C-DWG: DATE: 23,07,13 TITLE: DR500 S_Wire Rec_2~6Pin Pitch5.08 HSG P/N: 56**BG-***R****0000
				DRAW NO. SC2309327-1 DESIGN: JACKY CHECK: APPROVAL:
				SHEET: 1/3 SCALE: N/A UNIT: mm

1 2 3 4 5 6 7 8

X-ON Electronics

Largest Supplier of Electrical and Electronic Components

Click to view similar products for [Headers & Wire Housings](#) category:

Click to view products by [DEREN](#) manufacturer:

Other Similar products are found below :

[0015917161](#) [0022155065](#) [57102-F02-18ULF](#) [58102-G61-06LF](#) [582553-1](#) [01.001.5753.1](#) [0050291907](#) [02.125.8002.8](#) [609-3404](#) [61062-3](#)
[CSU011177004](#) [622-0430](#) [622-3653LF](#) [63453-116](#) [636-1030](#) [636-1427](#) [636-3427](#) [636-4007](#) [641938-9](#) [65495-038](#) [65692-001LF](#) [65781-018](#)
[65781-047](#) [65817-010LF](#) [65817-015LF](#) [67095-007LF](#) [67601157](#) [68631-112](#) [699319-000](#) [70.362.1628.0](#) [70-4210](#) [70-4226B](#) [70-4853B](#) [707-](#)
[5028](#) [71.350.2428.0](#) [733-134](#) [733-162](#) [760-3052](#) [MHR-64-VUAL](#) [80.063.4001.1](#) [800-90-001-10-001000](#) [801-43-002-10-013000](#)
[801-43-006-10-002000](#) [803-43-024-10-001000](#) [803-93-012-10-001000](#) [8-1437020-4](#) [819-22-004-30-001101](#) [820-22-006-30-001101](#)
[820-22-008-30-001101](#) [821-22-002-10-001101](#)