

REV.	ECN NO.	LOCATION	DESCRIPTION	DATE	DESIGN
X1			INITIAL RELEASE	22,11,28	JACKY
X3			Modify part number rules	23,06,30	JACKY
X4			Add packaging drawings	23,07,13	JACKY

NOTES:
PRODUCT MUST MEET CONTROLLED SUBSTANCES SPEC. ROHS 2.0
 1. MATERIAL: HOUSING: GLASS FILED THERMO PLASTIC POLYESTER
 COLOR: SEE MATERIAL NUMBER CODING RULES
 CONTACT: COPPER ALLOY
 RETENTION LEG: COPPER ALLOY
 2. FINISH(ALL OVER): NICKEL PLATING 30u" MIN
 3. FINISH(CONTACT AREA): GOLD PLATING SPECIFICATIONS
 REFER TO THE FOLLOWING MATERIAL
 NUMBER CODE SPECIFICATIONS
 4. FINISH(CONTACT TAIL): TIN PLATED 80u" MIN
 5. FINISH(RETENTION LEG): TIN PLATED
 6. PAIRING LINE END PLASTIC SPECIFICATION: SEE TABLE
 7. PAIRING LINE TERMINAL SPECIFICATION: 5600BG-003R*****
 8. UNSPECIFIED TOLERANCE: X.±0.50 X.±5"
 .X±0.40 .X±3"
 .XX±0.30 .XX±0.30
 9. PART NO.: 56**BG-**** * * * * V000

RESERVE NUMBER
 PACKAGE CODE:
 P: TUBE
 T: TRAY
 LOGO MARK:
 1: WITH DEREN LOGO
 2: WITHOUT LOGO
 PLATING CODE:
 4: Au-15u"
 6: BRIGHT-TIN: ALL OVER AREA
 HOUSING COLOR:
 1: BLACK
 2: WHITE
 WATER CODE: 001~ZZZ
 POS CODE:
 06: 6POS
 08: 8POS
 0A: 10POS
 0C: 12POS
 0E: 14POS
 0G: 16POS
 0J: 18POS
 0L: 20POS

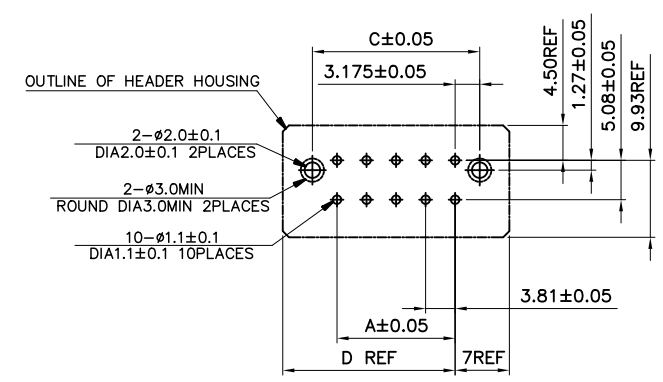
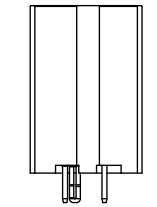
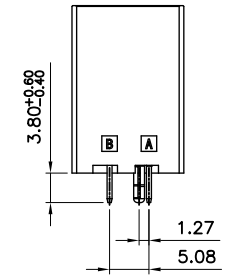
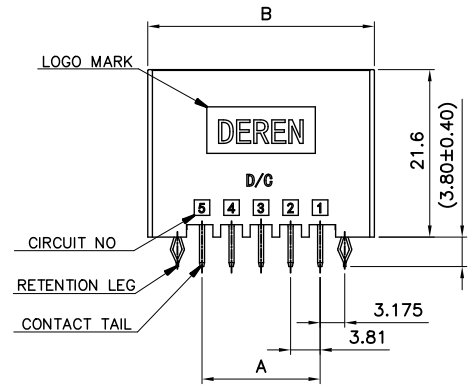
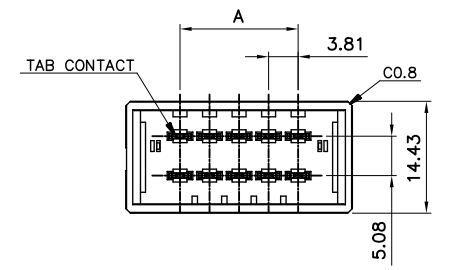

RECOMEND PC BOARD HOLE PATTERN
 PC BOARD THICKNESS: 1.6±0.1
 (NOT ACCUMULATE TOLERANCE)
 (CONNECTOR MOUNT SIDE)

POS	PART NUMBER	A	B	C	D	PAIRING LINE END PLASTIC SPECIFICATION
20	560LBC-013R****V000	34.29	48.29	40.64	41.29	560LBC-014R***00000
18	560JBG-005R****V000	30.48	44.48	36.83	37.48	560JBG-006R***00000
16	560GBG-011R****V000	26.67	40.67	33.02	33.67	560GBG-012R***00000
14	560EBG-005R****V000	22.86	36.86	29.21	29.86	560EBG-006R***00000
12	560CBG-011R****V000	19.05	33.05	25.40	26.05	560CBG-012R***00000
10	560ABG-015R****V000	15.24	29.24	21.59	22.24	560ABG-016R***00000
08	5608BG-008R****V000	11.43	25.43	17.78	18.43	5608BG-009R***00000
06	5606BG-014R****V000	7.62	21.62	13.97	14.62	5606BG-015R***00000

DIM	TOL	DIM	TOL	DEREN SHENZHEN DEREN ELECTRONIC CO., LTD					
X.	±0.30	X.	±2°		C-DWG:		DATE	TITLE: DR380 D_Board Plug_6~20Pin Pitch3.81 180°_DIP_ASSY	
.X	±0.25	.X	±1°		DRAW NO. SC2309323-1		DESIGN: JACKY	23,07,13	P/N: 56**BG-****R****V000
.XX	±0.20				REV. X4	APPROVAL:	CHECK:		SHEET: 1/3
								SCALE: N/A	UNIT: mm

1 2 3 4 5 6 7 8

REV.	ECN NO.	LOCATION	DESCRIPTION	DATE	DESIGN
X1			INITIAL RELEASE	22,11,28	JACKY
X3			Modify part number rules	23,06,30	JACKY
X4			Add packaging drawings	23,07,13	JACKY

A

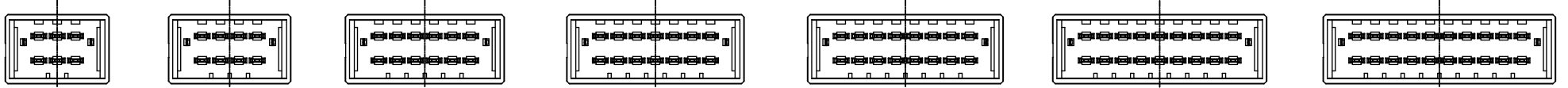

B

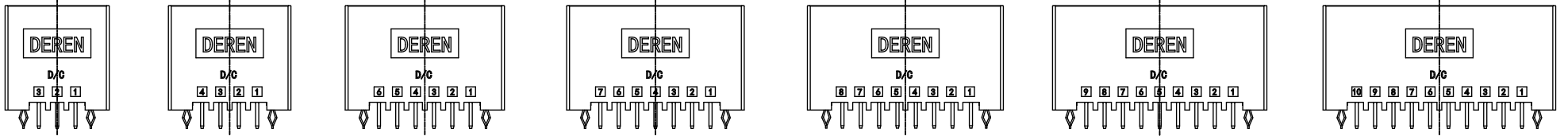

C

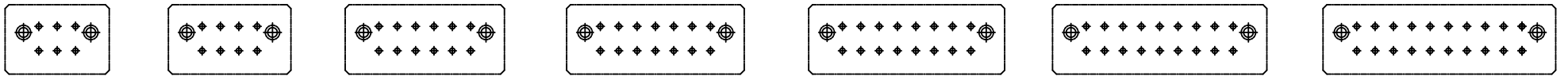

6POS

8POS

12POS

14POS



16POS

18POS

20POS

D

E

DIM	TOL	DIM	TOL	 DEREN SHENZHEN DEREN ELECTRONIC CO., LTD								
X.	±0.30	X.	±2°									
.X	±0.25	.X	±1°									
.XX	±0.20											
				DRAW NO.	DESIGN:	JACKY	DATE	23,07,13	TITLE:	DR380 D_Board Plug_6~20Pin Pitch3.81 180°_DIP_ASSY		
				SC2309323-1	CHECK:				P/N:	56**BG-***R****V000		
				REV.	X4	APPROVAL:			SHEET:	2/3		
									SCALE:	N/A	UNIT:	mm

1 2 3 4 5 6 7 8

1 2 3 4 5 6 7 8

REV.	ECN NO.	LOCATION	DESCRIPTION	DATE	DESIGN
X1			INITIAL RELEASE	22,11,28	JACKY
X3			Modify part number rules	23,06,30	JACKY
X4			Add packaging drawings	23,07,13	JACKY

A

B

C

D

E

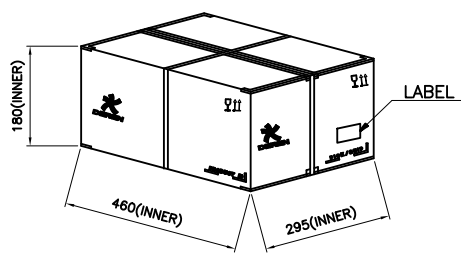
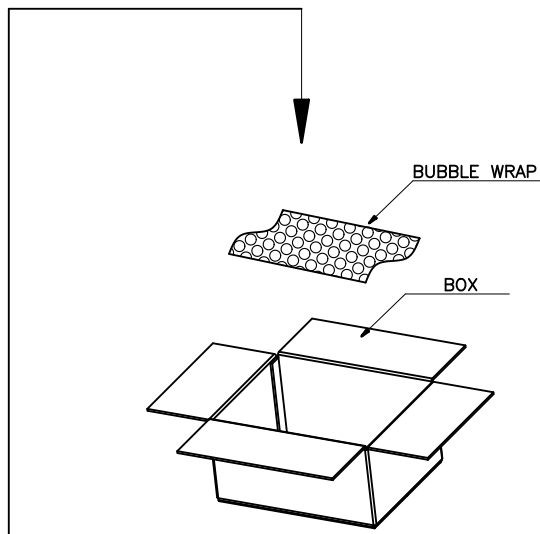
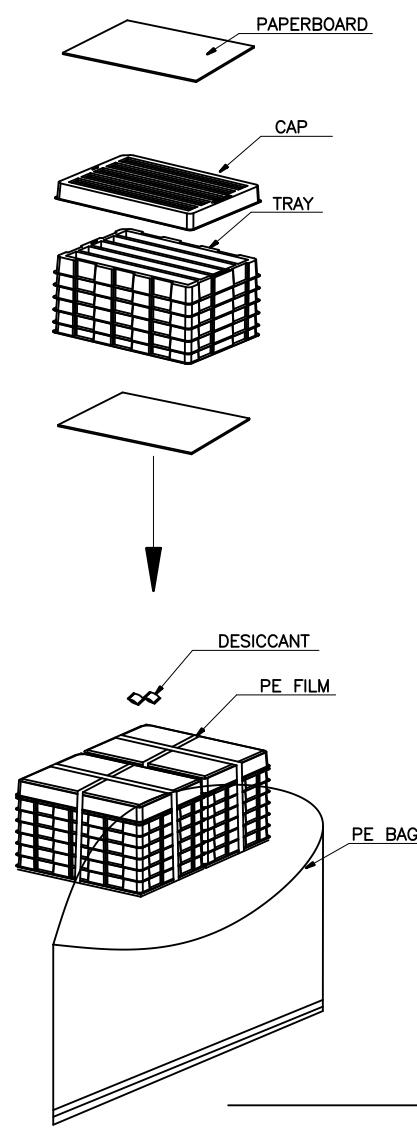

WITH DEREN LOGO
(Used for logo products)

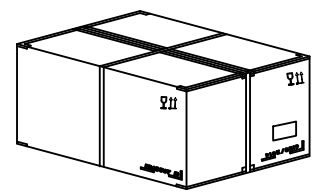

WITHOUT LOGO
(Used for logo-free products)

PACKAGE QUANTITY:

PART NO.	POS	PCS/TRAY	TRAY/BOX	PCS/BOX
5606BG-014R***TV000	6	55	12	660
5608BG-008R***TV000	8	50	12	600
560ABG-015R***TV000	10	40	12	480
560CBG-011R***TV000	12	35	12	420
560EBG-005R***TV000	14	30	12	360
560GBG-011R***TV000	16	30	12	360
560JBG-005R***TV000	18	25	12	300
560LBG-013R***TV000	20	25	12	300

DIM	TOL	DIM	TOL
X.	±0.30	X.	±2°
.X	±0.25	.X	±1°
.XX	±0.20		



DEREN
SHENZHEN DEREN ELECTRONIC CO., LTD

C-DWG:	DATE	TITLE: DR380 D_Board Plug_6~20Pin Pitch3.81 180_DIP_ASSY
DESIGN: JACKY	23,07,13	P/N: 56**BG-***R****V000
CHECK:		SHEET: 3/3
APPROVAL:		SCALE: N/A UNIT: mm

DRAW NO. SC2309323-1

REV. X4

1 2 3 4 5 6 7 8

X-ON Electronics

Largest Supplier of Electrical and Electronic Components

Click to view similar products for [Headers & Wire Housings](#) category:

Click to view products by [DEREN](#) manufacturer:

Other Similar products are found below :

[0015917161](#) [0022155065](#) [57102-F02-18ULF](#) [58102-G61-06LF](#) [582553-1](#) [01.001.5753.1](#) [0050291907](#) [02.125.8002.8](#) [609-3404](#) [61062-3](#)
[CSU011177004](#) [622-0430](#) [622-3653LF](#) [63453-116](#) [636-1030](#) [636-1427](#) [636-3427](#) [636-4007](#) [641938-9](#) [65495-038](#) [65692-001LF](#) [65781-018](#)
[65781-047](#) [65817-010LF](#) [65817-015LF](#) [67095-007LF](#) [67601157](#) [68631-112](#) [699319-000](#) [70.362.1628.0](#) [70-4210](#) [70-4226B](#) [70-4853B](#) [707-](#)
[5028](#) [71.350.2428.0](#) [733-134](#) [733-162](#) [760-3052](#) [MHR-64-VUAL](#) [80.063.4001.1](#) [800-90-001-10-001000](#) [801-43-002-10-013000](#)
[801-43-006-10-002000](#) [803-43-024-10-001000](#) [803-93-012-10-001000](#) [8-1437020-4](#) [819-22-004-30-001101](#) [820-22-006-30-001101](#)
[820-22-008-30-001101](#) [821-22-002-10-001101](#)