

HF

Halogen Free

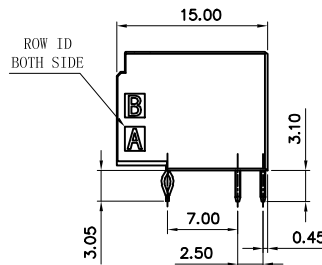
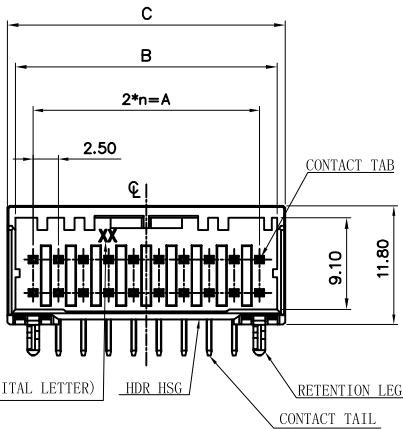
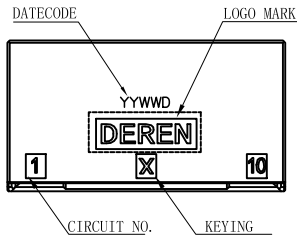
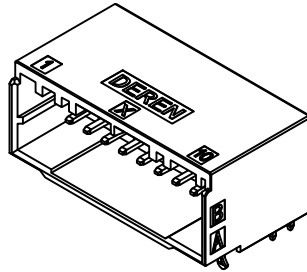
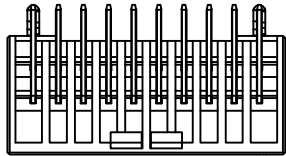

20POS: 560LBG-006H****T000

REV.	ECN NO.	LOCATION	DESCRIPTION	DATE	DESIGN
X1			INITIAL RELEASE	2022.09.08	tanghaibo
X2		1/2	新增规格	2022.10.29	tanghaibo
X3		2/3	修改编码电镀选项	2023.02.17	tanghaibo

- MATERIAL: HOUSING: GLASS FILED THERMO PLASTIC POLYESTER(94V-0)
COLOR: BLACK OR WHITE
CONTACT: COPPER ALLOY
RETENTION PEG: PRE-TIN COPPER ALLOY
- FINISH(ALL OVER): NICKEL PLATING 1.27um MIN
- FINISH(CONTACT AREA): GOLD PLATING TIN SPECIFICATIONS
REFER TO THE FOLLOWING MATERIAL NUMBER CODE SPECIFICATIONS
- FINISH(CONTACT TAIL): TIN PLATING 2um MIN AFTER
SHOW THE OUTLINE.
THEY DON'T SHOW DETAILS
- DATECODE: YYWW
YY: YEAR(22: 2022)
WW: WEEK(25: THE 25TH WEEK)
D: DAY(1~7: SUNDAY~SATURDAY)
- PART NO.: 56**BG-***H * * * * T000

- RESERVE NUMBER
- PACKAGE CODE:
 - P: TUBE
 - R: REEL
 - T: TRAY
- LOGO MARK:
 - 1: WITH DEREN LOGO
 - 2: WITHOUT LOGO
- PLATING CODE: 1/2
 - 4: Au:15u"
 - 6: Sn:OVER TIN
- HOUSING COLOR:
 - 1: BLACK
 - 2: WHITE
- WATER CODE: 001~ZZZ
- POS CODE: 20POS: 0L
16POS: 0G
12POS: 0C
10POS: 0A
08POS: 08
06POS: 06
04POS: 04

20	X	9	22.5	26.0	27.6	560LBG-006H****T000	560LBG-008H****00000
16	X	7	17.5	21.0	22.6	560GBG-001H****T000	560GBG-005H****00000
12	X	5	12.5	16.0	17.6	560CBG-001H****T000	560CBG-005H****00000
10	X	4	10.0	13.5	15.1	560ABG-005H****T000	560ABG-009H****00000
08	X	3	7.5	11.0	12.6	5608BG-001H****T000	5608BG-003H****00000
06	X	2	5.0	8.5	10.1	5606BG-001H****T000	5606BG-005H****00000
04	X	1	2.5	6.0	7.6	5604BG-001H****T000	5604BG-004H****00000
POS	KEY	n	A	B	C	MALE PART NO.	FEMALE PART NO.

DIM	TOL	DIM	TOL
x.	±0.30	x.	±5'
.x	±0.30	.x	±3'
.xx	±0.30		

DEREN
SHENZHEN DEREN ELECTRONIC CO., LTD

DRAW NO.	DESIGN: Tanghaibo	DATE: 2023.02.17	TITLE: WTB Male XXP 15H Pitch2.5 90DIP ASSY
***	CHECK:		P/N: 56**BG-***H****T000
REV. X3	APPROVAL:		SHEET: 1/3
			SCALE: 1:1 UNIT: mm

HF

Halogen Free

REV.	ECN NO.	LOCATION	DESCRIPTION	DATE	DESIGN
X1			INITIAL RELEASE	2022.09.08	tanghaibo
X2		ⓧ _{X2}	新增规格	2022.10.29	tanghaibo
X3		ⓧ _{X3}	修改编码电镀选项	2023.02.17	tanghaibo

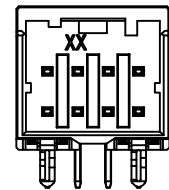
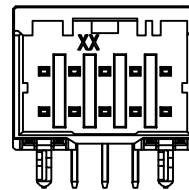
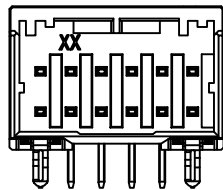
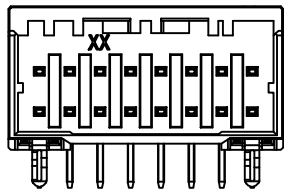
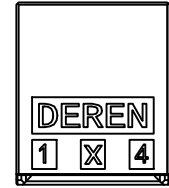
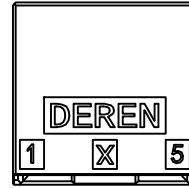
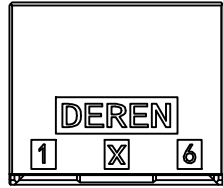
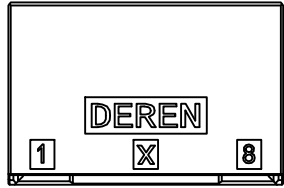
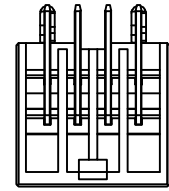
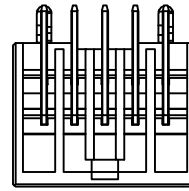
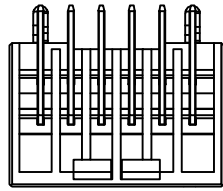
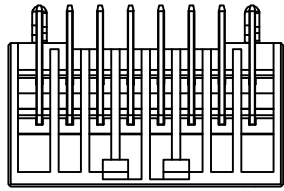

16POS: 560BG-001H****T000

12POS: 560CBG-001H****T000

10POS: 560ABG-005H****T000

08POS: 5608BG-001H****T000

DIM	TOL	DIM	TOL
x.	±0.30	x.	±5'
.x	±0.30	.x	±3'
.xx	±0.30		



DEREN
SHENZHEN DEREN ELECTRONIC CO., LTD

CUSTOMER DRAWING	DATE	TITLE: WT8 Male XXP 15H Pitch2.5 90DIP ASSY
DESIGN: Tanghaibo	2023.02.17	P/N: 56**BG-****H****T000
CHECK:		SHEET: 2/3
APPROVAL:		SCALE: 1:1 UNIT: mm

DRAW NO. ***
REV. X3

HF

Halogen Free

REV.	ECN NO.	LOCATION	DESCRIPTION	DATE	DESIGN
X1			INITIAL RELEASE	2022.09.08	tanghaibo
X2		⊗ _{X2}	新增规格	2022.10.29	tanghaibo
X3		⊗ _{X3}	修改编码电镀选项	2023.02.17	tanghaibo

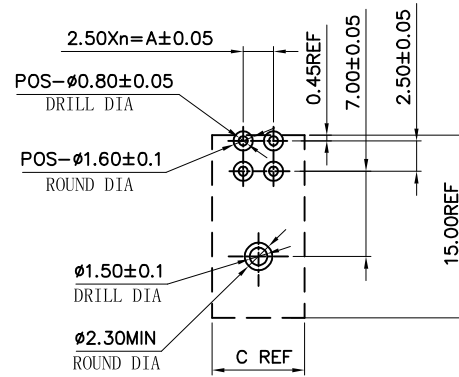
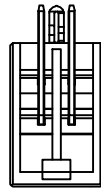
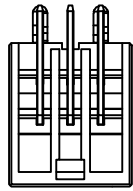

RECOMMEND PC BOARD HOLE PATTERN:
CONNECTOR MOUNT SIDE
(NOT ACCUMULATE TOLERANCE)
PC BOARD THICKENSS: 1.0~1.6±0.10
ONLY 4POS

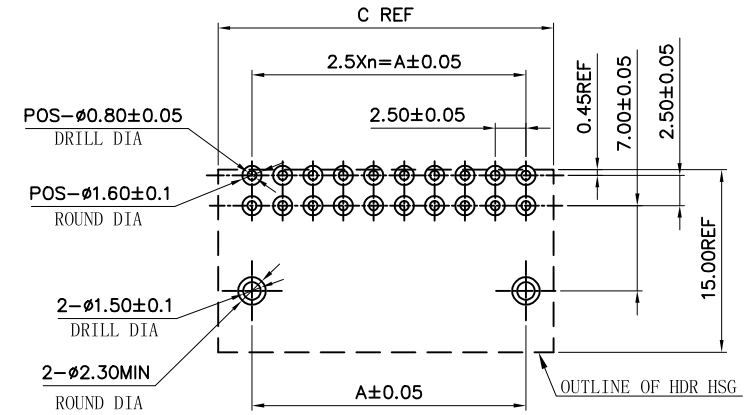

RECOMMEND PC BOARD HOLE PATTERN:
CONNECTOR MOUNT SIDE
(NOT ACCUMULATE TOLERANCE)
PC BOARD THICKENSS: 1.0~1.6±0.10

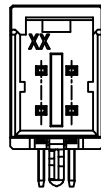
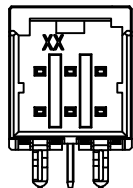

ROW ID
BOTH SIDE

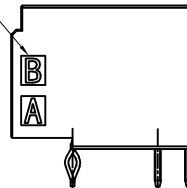

06POS: 5606BG-001H****T000

04POS: 5604BG-001H****T000

DIM	TOL	DIM	TOL
x.	±0.30	x.	±5'
.x	±0.30	.x	±3'
.xx	±0.30		

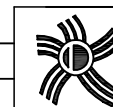

DEREN
SHENZHEN DEREN ELECTRONIC CO., LTD

CUSTOMER DRAWING		DATE	TITLE: WT8 Male XXP 15H Pitch2.5 90DIP ASSY
DESIGN: Tanghaibo	2023.02.17	P/N: 56**BG-****H****T000	
CHECK:		SHEET: 3/3	
APPROVAL:		SCALE: 1:1	UNIT: mm

DRAW NO. ***
REV. X3

X-ON Electronics

Largest Supplier of Electrical and Electronic Components

Click to view similar products for [Headers & Wire Housings](#) category:

Click to view products by [DEREN](#) manufacturer:

Other Similar products are found below :

[0015917161](#) [0022155065](#) [57102-F02-18ULF](#) [58102-G61-06LF](#) [582553-1](#) [01.001.5753.1](#) [0050291907](#) [02.125.8002.8](#) [609-3404](#) [61062-3](#)
[CSU011177004](#) [622-0430](#) [622-3653LF](#) [63453-116](#) [636-1030](#) [636-1427](#) [636-3427](#) [636-4007](#) [641938-9](#) [65495-038](#) [65692-001LF](#) [65781-018](#)
[65781-047](#) [65817-010LF](#) [65817-015LF](#) [67095-007LF](#) [67601157](#) [68631-112](#) [699319-000](#) [70.362.1628.0](#) [70-4210](#) [70-4226B](#) [70-4853B](#) [707-](#)
[5028](#) [71.350.2428.0](#) [733-134](#) [733-162](#) [760-3052](#) [MHR-64-VUAL](#) [80.063.4001.1](#) [800-90-001-10-001000](#) [801-43-002-10-013000](#)
[801-43-006-10-002000](#) [803-43-024-10-001000](#) [803-93-012-10-001000](#) [8-1437020-4](#) [819-22-004-30-001101](#) [820-22-006-30-001101](#)
[820-22-008-30-001101](#) [821-22-002-10-001101](#)