

REV.	ECN NO.	LOCATION	DESCRIPTION	DATE	DESIGN
X1			INITIAL RELEASE	22,11,28	JACKY
X3			Modify part number rules	23,06,30	JACKY
X4			Add packaging drawings	23,07,13	JACKY

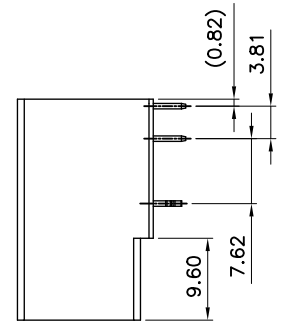

- NOTES:
- PRODUCT MUST MEET CONTROLLED SUBSTANCES SPEC. ROHS 2.0
- MATERIAL: HOUSING: GLASS FILED THERMO PLASTIC POLYESTER
COLOR: SEE MATERIAL NUMBER CODING RULES
CONTACT: COPPER ALLOY
RETENTION LEG: COPPER ALLOY
 - FINISH(ALL OVER): NICKEL PLATING 30u" MIN
 - FINISH(CONTACT AREA): GOLD PLATING SPECIFICATIONS
REFER TO THE FOLLOWING MATERIAL NUMBER CODE SPECIFICATIONS
 - FINISH(CONTACT TAIL): TIN PLATED 80u" MIN
 - FINISH(RETENTION LEG): TIN PLATED
 - PAIRING LINE END PLASTIC SPECIFICATION: SEE TABLE
 - PAIRING LINE TERMINAL SPECIFICATION: 5600BG-003R*****
 - UNSPECIFIED TOLERANCE: X:±0.50 X:±5"
.X±0.40 .X±3"
.XX±0.30
 - PART NO.: 56**BG-***R * * * * T000

- RESERVE NUMBER
- PACKAGE CODE: P: TUBE T: TRAY
- LOGO MARK: 1: WITH DEREN LOGO 2: WITHOUT LOGO
- PLATING CODE: 4: Au :15u" 6: BRIGHT-TIN: ALL OVER AREA
- HOUSING COLOR: 1: BLACK 2: WHITE
- WATER CODE: 001~ZZZ
- POS CODE: 06: 6POS 08: 8POS 0A: 10POS 0C: 12POS 0E: 14POS 0G: 16POS 0J: 18POS 0L: 20POS

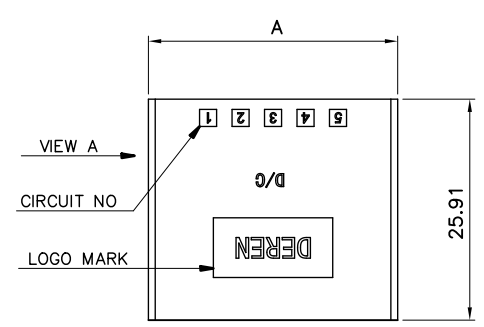
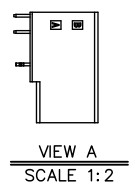
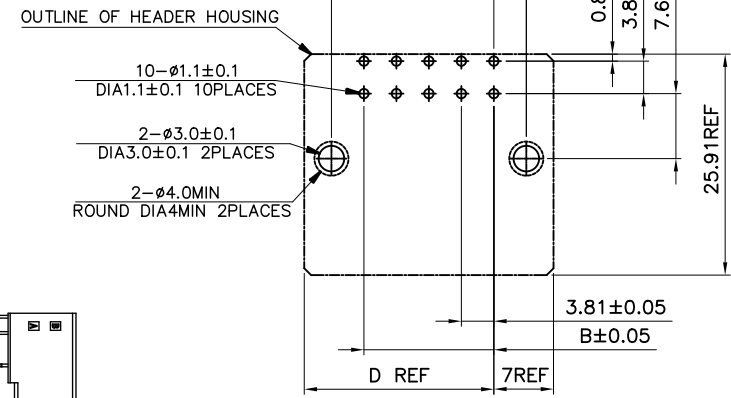
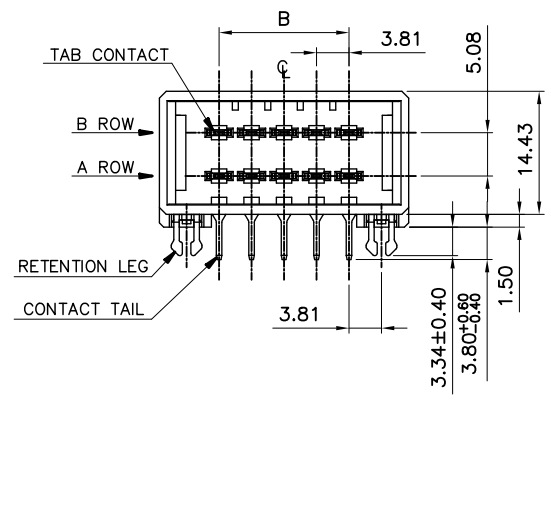

RECOMEND PC BOARD HOLE PATTERN
PC BOARD THICKENSS: 1.6±0.1
(NOT ACCUMULATE TOLERANCE)
(CONNECTOR MOUNT SIDE)

20	560LBG-012R****T000	48.29	34.29	41.91	41.29	560LBG-014R***00000
18	560JBG-004R****T000	44.48	30.48	38.10	37.48	560JBG-006R***00000
16	560GBG-010R****T000	40.67	26.67	34.29	33.67	560GBG-012R***00000
14	560EBG-004R****T000	36.86	22.86	30.48	29.86	560EBG-006R***00000
12	560CBG-010R****T000	33.05	19.05	26.67	26.05	560CBG-012R***00000
10	560ABG-014R****T000	29.24	15.24	22.86	22.24	560ABG-016R***00000
08	5608BG-007R****T000	25.43	11.43	19.05	18.43	5608BG-009R***00000
06	5606BG-013R****T000	21.62	7.62	15.24	14.62	5606BG-015R***00000
POS	PART NUMBER	A	B	C	D	PAIRING LINE END PLASTIC SPECIFICATION

DIM	TOL	DIM	TOL
X.	±0.30	X.	±2°
.X	±0.25	.X	±1°
.XX	±0.20		

DEREN
SHENZHEN DEREN ELECTRONIC CO., LTD

C-DWG:	DATE	TITLE: DR380 D_Board Plug_6~20Pin Pitch3.81 90°_DIP_ASSY
DESIGN: JACKY	23,07,13	P/N: 56**BG-***R****T000
CHECK:		SHEET: 1/3
APPROVAL:		SCALE: N/A UNIT: mm

DRAW NO. SC2309322-1
REV. X4

A
B
C
D
E

REV.	ECN NO.	LOCATION	DESCRIPTION	DATE	DESIGN
X1			INITIAL RELEASE	22,11,28	JACKY
X3			Modify part number rules	23,06,30	JACKY
X4			Add packaging drawings	23,07,13	JACKY

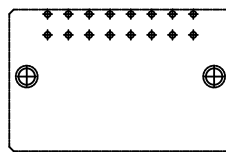
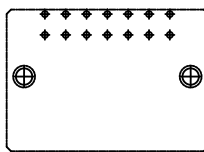
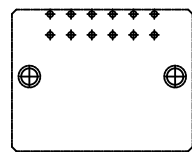
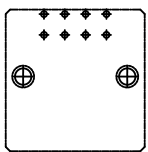
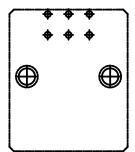
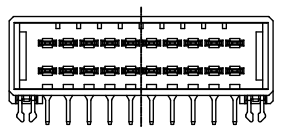
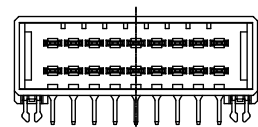
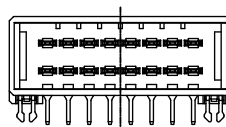
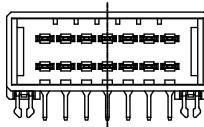
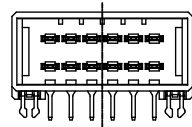
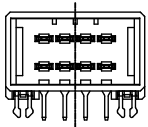
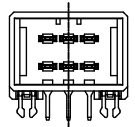
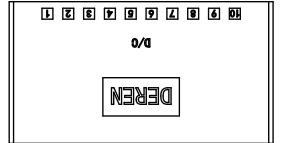
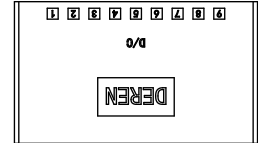
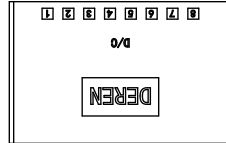
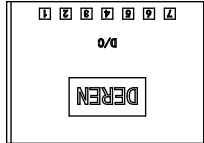
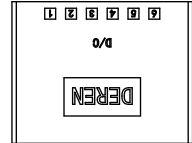
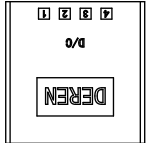
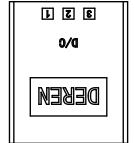

6POS

8POS



12POS

14POS

16POS

18POS

20POS

DIM	TOL	DIM	TOL	 DEREN SHENZHEN DEREN ELECTRONIC CO., LTD				
X.	±0.30	X.	±2°					
.X	±0.25	.X	±1°					
.XX	±0.20							
		DRAW NO.		C-DWG:	DATE	TITLE: DR380 D_Board Plug_6~20Pin Pitch3.81 90°_DIP_ASSY		
		SC2309322-1						DESIGN:
		REV. X4		CHECK:		SHEET:	2/3	
		APPROVAL:		SCALE:	N/A	UNIT:	mm	

1 2 3 4 5 6 7 8

REV.	ECN NO.	LOCATION	DESCRIPTION	DATE	DESIGN
X1			INITIAL RELEASE	22,11,28	JACKY
X3			Modify part number rules	23,06,30	JACKY
X4			Add packaging drawings	23,07,13	JACKY

A

B

C

D

E

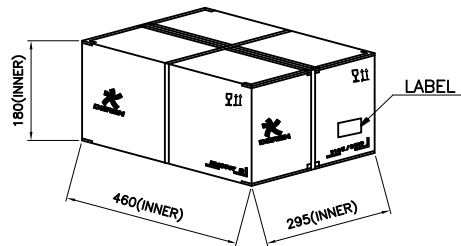
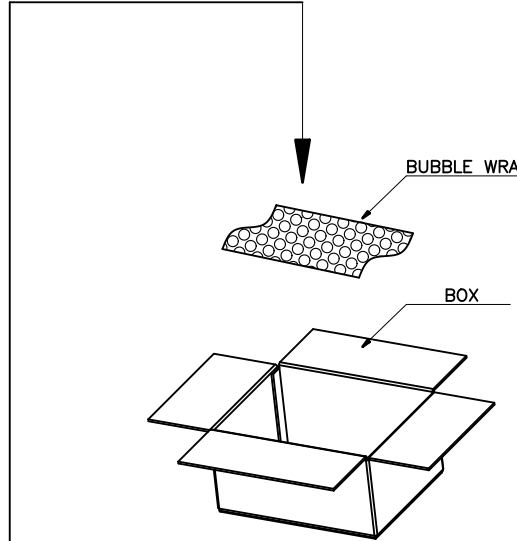
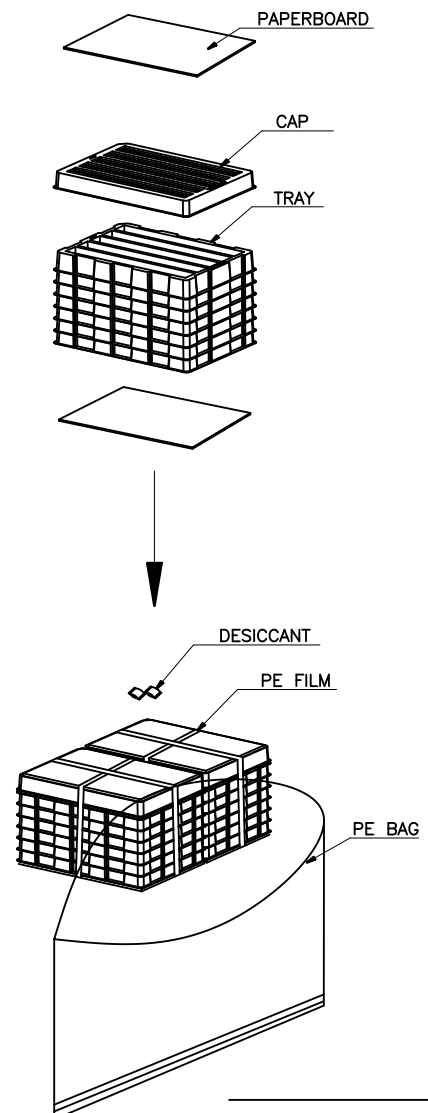

WITH DEREN LOGO
(Used for logo products)

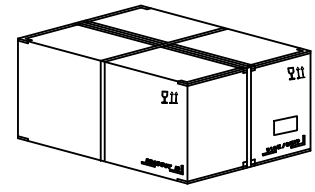

WITHOUT LOGO
(Used for logo-free products)

PACKAGE QUANTITY:

PART NO.	POS	PCS/TRAY	TRAY/BOX	PCS/BOX
5606BG-013R***TT000	6	55	12	660
5608BG-007R***TT000	8	50	12	600
560ABG-014R***TT000	10	40	12	480
560CBG-010R***TT000	12	35	12	420
560EBG-004R***TT000	14	30	12	360
560GBG-010R***TT000	16	30	12	360
560JBG-004R***TT000	18	25	12	300
560LBG-012R***TT000	20	25	12	300

DIM	TOL	DIM	TOL
X.	±0.30	X.	±2°
.X	±0.25	.X	±1°
.XX	±0.20		



DEREN
SHENZHEN DEREN ELECTRONIC CO., LTD

DRAW NO.
SC2309322-1

C-DWG: [] DATE: 23,07,13
DESIGN: JACKY
CHECK: []
APPROVAL: []

TITLE: DR380 D_Board Plug_6~20Pin Pitch3.81 90°_DIP_ASSY
P/N: 56**BG-***R***T000
SHEET: 3/3
SCALE: N/A UNIT: mm

1 2 3 4 5 6 7 8

X-ON Electronics

Largest Supplier of Electrical and Electronic Components

Click to view similar products for [Headers & Wire Housings](#) category:

Click to view products by [DEREN](#) manufacturer:

Other Similar products are found below :

[0015917161](#) [0022155065](#) [57102-F02-18ULF](#) [58102-G61-06LF](#) [582553-1](#) [01.001.5753.1](#) [0050291907](#) [02.125.8002.8](#) [609-3404](#) [61062-3](#)
[CSU011177004](#) [622-0430](#) [622-3653LF](#) [63453-116](#) [636-1030](#) [636-1427](#) [636-3427](#) [636-4007](#) [641938-9](#) [65495-038](#) [65692-001LF](#) [65781-018](#)
[65781-047](#) [65817-010LF](#) [65817-015LF](#) [67095-007LF](#) [67601157](#) [68631-112](#) [699319-000](#) [70.362.1628.0](#) [70-4210](#) [70-4226B](#) [70-4853B](#) [707-](#)
[5028](#) [71.350.2428.0](#) [733-134](#) [733-162](#) [760-3052](#) [MHR-64-VUAL](#) [80.063.4001.1](#) [800-90-001-10-001000](#) [801-43-002-10-013000](#)
[801-43-006-10-002000](#) [803-43-024-10-001000](#) [803-93-012-10-001000](#) [8-1437020-4](#) [819-22-004-30-001101](#) [820-22-006-30-001101](#)
[820-22-008-30-001101](#) [821-22-002-10-001101](#)