

REV.	ECN NO.	LOCATION	DESCRIPTION	DATE	DESIGN
1			INITIAL RELEASE	2023.03.14	Yy_D

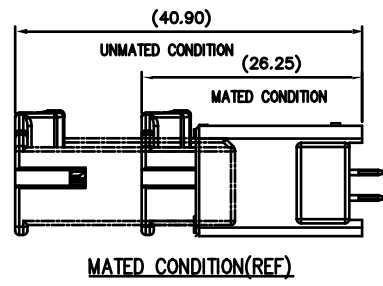

NOTES:
 PRODUCT MEETS CONTROLLED SUBSTANCES SPEC. ROHS 2.0
 1. MATERIAL:
 1.1 HOUSING: PPS, UL94V-0; COLOR: BLACK.
 1.2 CONTACT: BRASS.
 2. FINISH:
 2.1 CONTACT: TIN ON CONTACT AREA.
 50u"~100u"MIN. TIN PLATING ON SOLDER TAIL AREA.
 100u"~180u". NICKEL UNDERPLATING OVERALL.
 3. ELECTRICAL SPECIFICATION:
 3.1 VOLTAGE RATING: 50V MAX. AC/DC.
 3.2 CURRENT RATING: 3A MAX. AC/DC.
 3.3 WITHSTANDING VOLTAGE: 1000V AC/MINUTE.
 3.4 TEMPERATURE RANGE: -40°C~+125°C
 3.5 INSULATION RESISTANCE: 1000MΩ.
 3.6 CONTACT RESISTANCE: <5MΩ MAX.AFTER ENVIRONMENT TESTING:<10MΩ

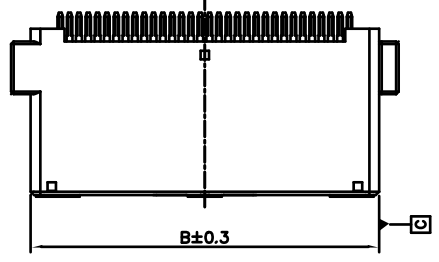
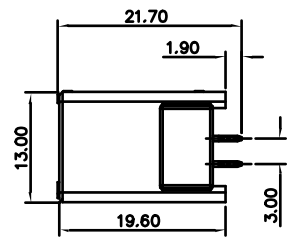
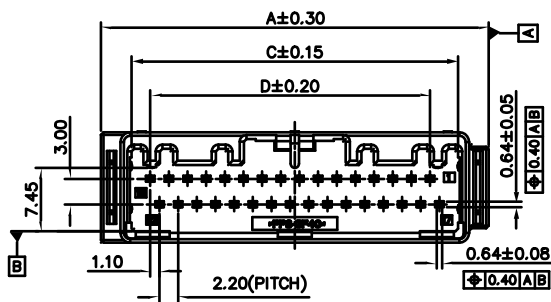

570CBG-032R***T**

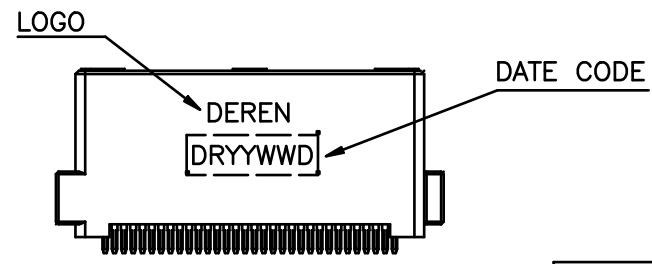

CUSTOMER CODE
 T:TUBE
 R:REEL
 PIN:
 12:12PIN

 40:40PIN
 PLATING:
 1:MATTE-SN
 2:BRIGHT SN
 SPECIAL NO.
 1:WITH LOGO
 2:WITHOUT LOGO
 R:RoHS
 H:HALOGEN-FREE
 WAFER



Poles	Dimensions (mm)			
	A	B	C	D
2*06	23.70	19.10	16.50	11.00
2*08	28.10	23.50	20.90	15.40
2*10	32.50	27.90	25.30	19.80
2*12	36.90	32.30	29.70	24.20
2*14	41.30	36.70	34.10	28.60
2*16	45.70	41.10	38.50	33.00
2*18	50.10	45.50	43.00	37.40
2*20	54.50	49.90	47.40	41.80

DIM	TOL	DIM	TOL
x	±0.35	x	±2'
.x	±0.30		
.xx	±0.25		

	DEREN		SHENZHEN DEREN ELECTRONIC CO., LTD	
	CUSTOMER DRAWING	DATE	TITLE: WAFER 2.20PH 19.8H VERTICAL DIP GOWN	
	DESIGN: Yy_D	2023.03.14	P/N:SEE TABLE	
	CHECK:		SHEET: 1/3	
REV. 1	APPROVAL:	SCALE: 1:1	UNIT: mm	

1 2 3 4 5 6 7 8

A

A

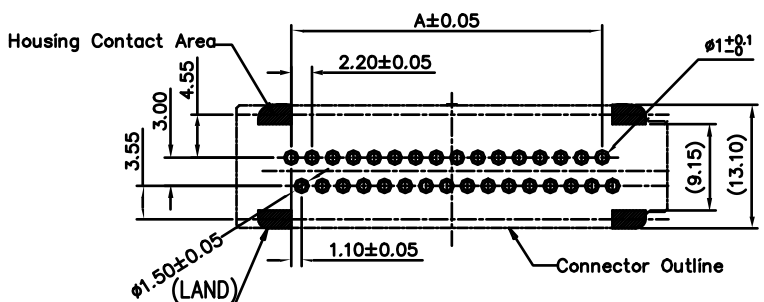

APPLICABLE P.C.B LAYOUT(REF.)
P.C.B THICKNESS t=1.6mm

B

B

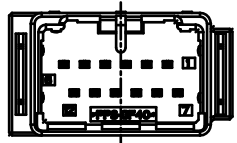

2*06PIN

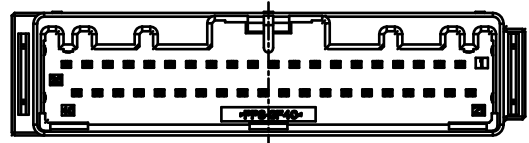

2*20PIN

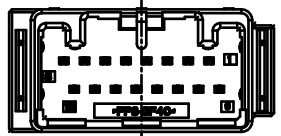

2*08PIN

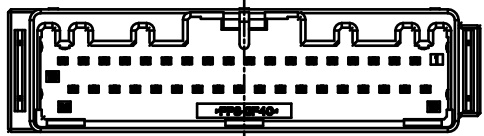

2*18PIN

C

C

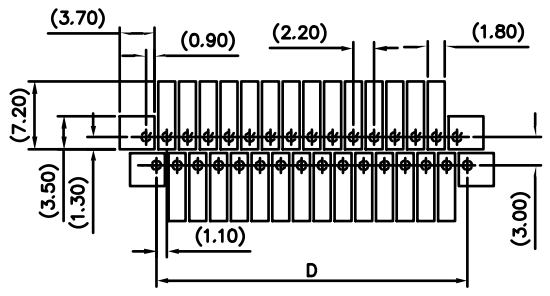

METAL MASK DIMENSIONS(REF)
MASK THICKNESS T=0.15mm

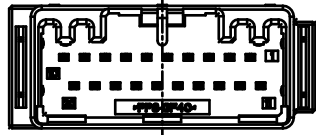

2*10PIN

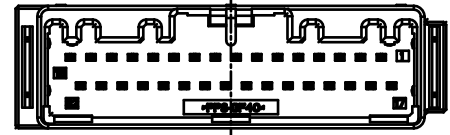

2*16PIN

D

D

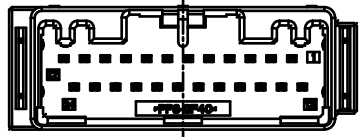

2*12PIN

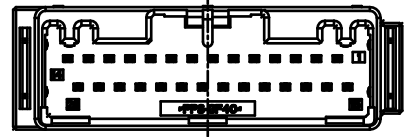

2*14PIN

E

E

1 2 3 4 5 6 7 8

DIM	TOL	DIM	TOL
x	±0.35	x	±2°
.x	±0.30		
.xx	±0.25		

	DEREN		
	SHENZHEN DEREN ELECTRONIC CO., LTD		
	CUSTOMER DRAWING	DATE	TITLE: WAFER 2.20PH 19.0H VERTICAL DIP CONN
	DESIGN: yy_D	2023.03.14	P/N:SEE TABLE
DRAW NO. ***	CHECK:	SHEET: 2/3	
REV. 1	APPROVAL:	SCALE: 1:1	

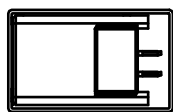
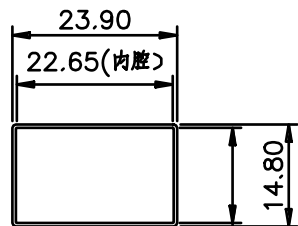

匹配图不带鱼叉

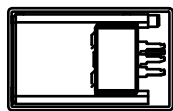

匹配图带鱼叉

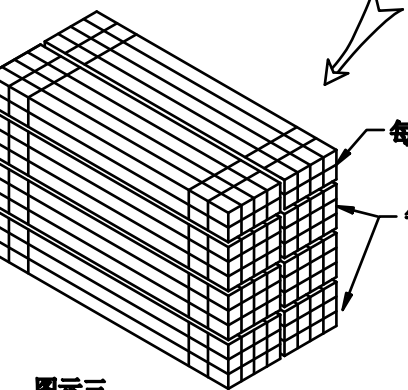

图示三
3. 将每扎管子包扎

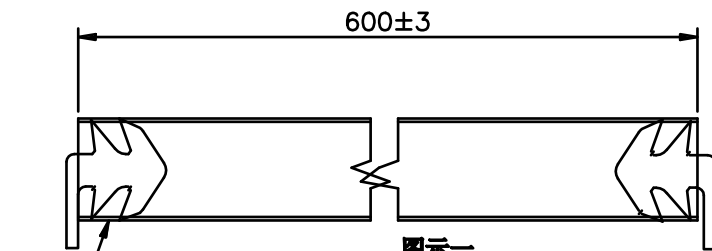

图示一
1. 将产品依次装入管中

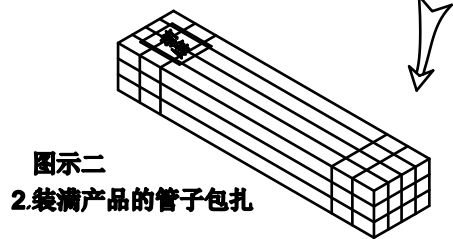

图示二
2. 装满产品的管子包扎

胶带ADHESIVE TAPE

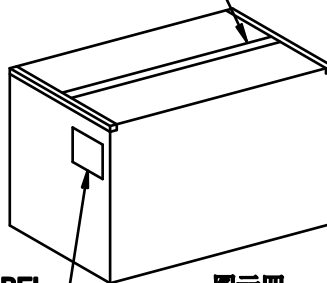

图示四
4. 装箱, 封胶

说明:

1. 将产品依图示方向放入真空管内, 方向须一致, 每个真空管放的产品数量依Pin数不同而不同, 具体详见包装明细表, 真空管两头用胶塞塞住, 如图示一。
2. 将装好产品的真空管平放在桌面上以4PCS为一排然后再叠放3列或2列为1把如图二或图三, 整理好后用PE膜将1把真空管两头PE膜缠绕包好, 并在左边PE膜处贴1PCS产品标签, 如图示二。
3. 将上步完成的产品以每把进行包扎, 包装成一整扎, 以图示三
4. 将包扎好的产品放入纸箱内, 并将纸箱用胶带封好, 在其侧面右上角贴上出货标签。
5. 纸箱规格: 600*200*180mm 真空管规格: 600*14.4*14.6mm
6. 纸箱厚度: 6~7mm

PIN数	每支真空产品数量PCS/管	每箱真空管数量 PCS管/箱	每箱包装数量 PCS/箱
2*06	24	88	2112
2*08	20	88	1760
2*10	17	88	1496
2*12	15	88	1320
2*14	13	88	1144
2*16	12	88	1056
2*18	11	88	968
2*20	10	88	880

DIM	TOL	DIM	TOL
x	/	x	/
.x			
.xx			

DEREN
SHENZHEN DEREN ELECTRONIC CO., LTD

DRAW NO. ***	DESIGN: Yy_D	DATE 2023.03.14	TITLE: WAFER 2.20PH 19.8H VERTICAL DIP CONN
REV. 1	CHECK:	APPROVAL:	P/N: SEE TABLE
			SHEET: 3/3
			SCALE: N/A UNIT: mm

X-ON Electronics

Largest Supplier of Electrical and Electronic Components

Click to view similar products for [Headers & Wire Housings](#) category:

Click to view products by [DEREN](#) manufacturer:

Other Similar products are found below :

[0015917161](#) [0022155065](#) [57102-F02-18ULF](#) [58102-G61-06LF](#) [582553-1](#) [01.001.5753.1](#) [0050291907](#) [02.125.8002.8](#) [609-3404](#) [61062-3](#)
[CSU011177004](#) [622-0430](#) [622-3653LF](#) [63453-116](#) [636-1030](#) [636-1427](#) [636-3427](#) [636-4007](#) [641938-9](#) [65495-038](#) [65692-001LF](#) [65781-018](#)
[65781-047](#) [65817-010LF](#) [65817-015LF](#) [67095-007LF](#) [67601157](#) [68631-112](#) [699319-000](#) [70.362.1628.0](#) [70-4210](#) [70-4226B](#) [70-4853B](#) [707-](#)
[5028](#) [71.350.2428.0](#) [733-134](#) [733-162](#) [760-3052](#) [MHR-64-VUAL](#) [80.063.4001.1](#) [800-90-001-10-001000](#) [801-43-002-10-013000](#)
[801-43-006-10-002000](#) [803-43-024-10-001000](#) [803-93-012-10-001000](#) [8-1437020-4](#) [819-22-004-30-001101](#) [820-22-006-30-001101](#)
[820-22-008-30-001101](#) [821-22-002-10-001101](#)