

REV.	ECN NO.	LOCATION	DESCRIPTION	DATE	DESIGN
1			INITIAL RELEASE	2023.03.01	Yy_D

NOTES:
 PRODUCT MEETS CONTROLLED SUBSTANCES SPEC. ROHS 2.0
 1. MATERIAL:
 1.1 HOUSING: PPE+PS, UL94V-0; COLOR: SEE TABLE.
 1.2 CONTACT: BRASS.
 2. FINISH:
 2.1 CONTACT: 100u"MIN. TIN PLATING OVERALL.
 50u". NICKEL UNDERPLATING OVERALL.
 3. ELECTRICAL SPECIFICATION:
 3.1 VOLTAGE RATING: 50V MAX. AC/DC.
 3.2 CURRENT RATING: 3A MAX. AC/DC.
 3.3 WITHSTANDING VOLTAGE: 1000V AC/MINUTE.
 3.4 TEMPERATURE RANGE: -40°C~+125°C
 3.5 INSULATION RESISTANCE: 1000MΩ.
 3.6 CONTACT RESISTANCE: <5MΩ MAX.AFTER ENVIRONMENT TESTING:<10MΩ

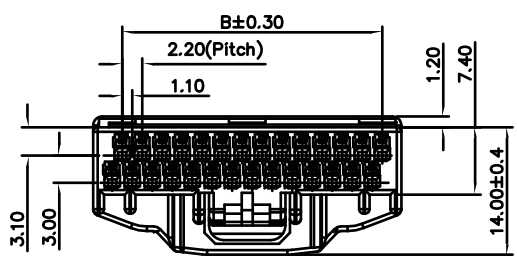
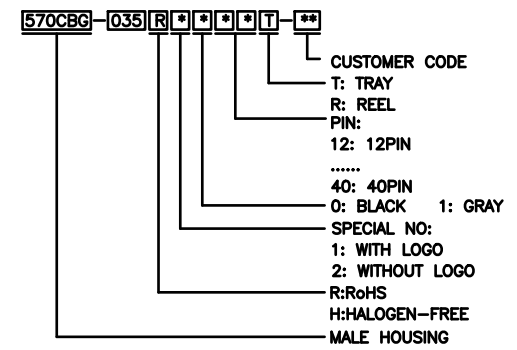
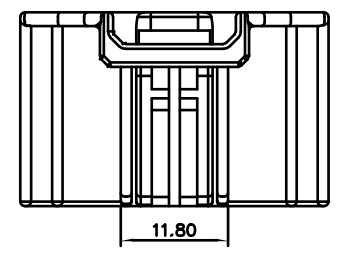
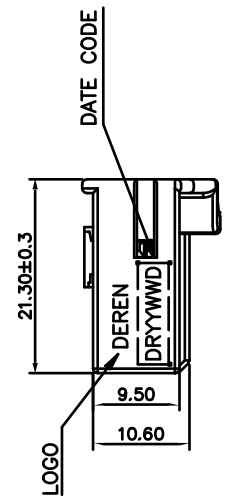
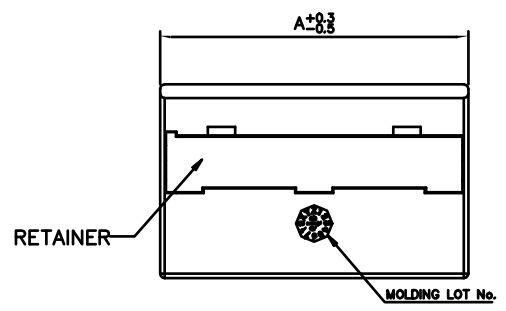
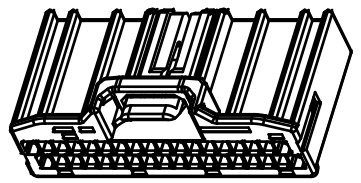
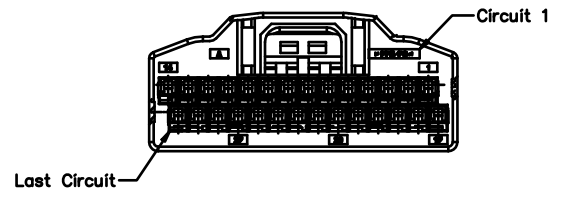

Poles	A	B
2*06	16.30	11.00
2*08	20.70	15.40
2*10	25.10	19.80
2*12	29.50	24.20
2*14	33.90	28.60
2*16	38.30	33.00
2*18	42.70	37.40
2*20	47.10	41.80

DIM	TOL	DIM	TOL
x	±0.35	x	±2'
.x	±0.30		
.xx	±0.25		

DEREN
 SHENZHEN DEREN ELECTRONIC CO., LTD

DRAW NO.	CUSTOMER DRAWING		DATE	TITLE: WAFER MALE HOUSING 21.3H		
	***	DESIGN: Yy_D	2023.03.14	P/N:SEE TABLE		
REV.	1	CHECK:	APPROVAL:	SHEET:	1/3	
				SCALE:	1:1	UNIT: mm

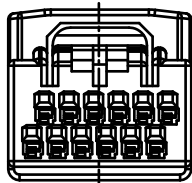

2*06PIN

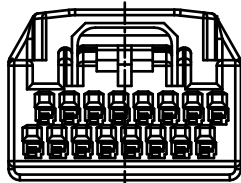

2*08PIN

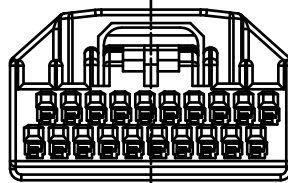

2*10PIN

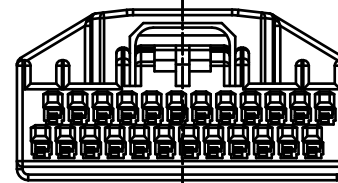

2*12PIN

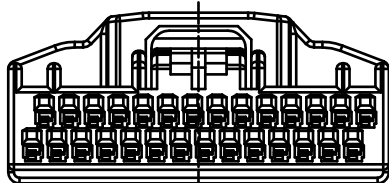

2*14PIN

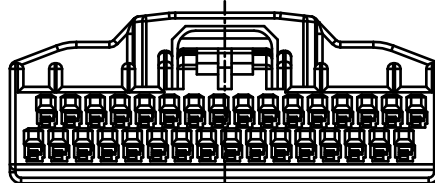

2*16PIN

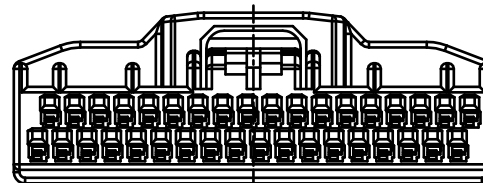

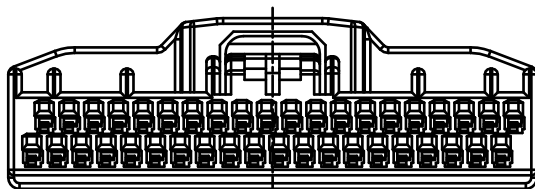

2*18PIN



2*20PIN

DIM	TOL	DIM	TOL
x	±0.35	x	±2°
.x	±0.30		
.xx	±0.25		

	DEREN SHENZHEN DEREN ELECTRONIC CO., LTD			
	CUSTOMER DRAWING		DATE	TITLE: WAFER MALE HOUSING 21.3H
	DRAW NO.	DESIGN: yy_D	2023.03.14	P/N:SEE TABLE
	REV. 1	CHECK:		SHEET: 2/3 
APPROVAL:			SCALE: 1:1 UNIT: mm	

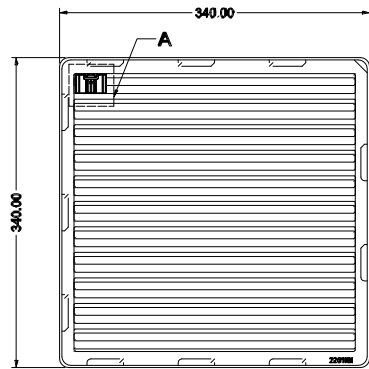

步骤:1

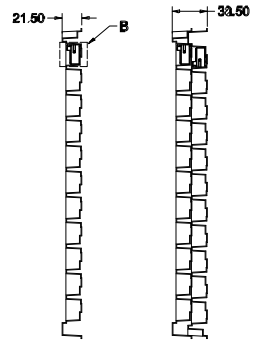

步骤:2

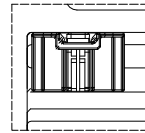

局部放大图A
比例3:1

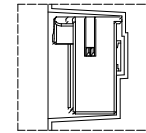

局部放大图B
比例5:1

Pin位	盘/Pcs	箱/盘	箱/Pcs
2*06	198	12	2376
2*08	154	12	1848
2*10	132	12	1584
2*12	110	12	1320
2*14	99	12	1188
2*16	88	12	1056
2*18	77	12	924
2*20	66	12	792

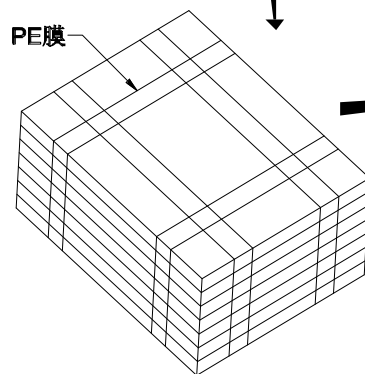

步骤:2

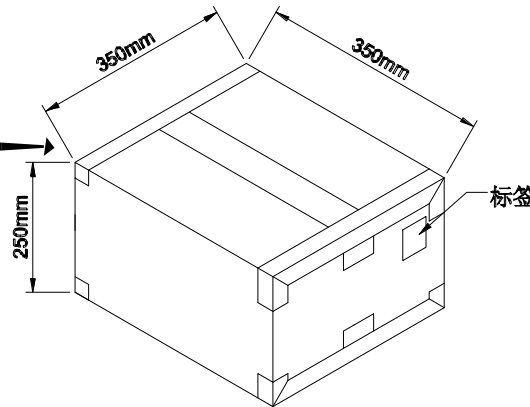

步骤:3

包装说明:

步骤1: 将检验好的良品整齐摆放入吸塑盘。

吸塑盘规格: 340*340*20.7mm

吸塑盘材质: 透明PET;

步骤2: 在重叠吸塑盘时, 上下层吸塑盘方向需错开摆放, 12盘叠起来为1扎, 最顶层再放1PCS空吸塑盘当上盖用, 然后用PE膜扎住。

步骤3: 一纸箱里放1扎, 共12盘, 然后用透明胶带封箱, 贴上外箱标签。

纸箱规格: 350*350*250mm

纸箱材质: K=K; 纸箱厚度: 6~7mm

DIM	TOL	DIM	TOL
x.	/	x.	/
.x			
.xx			

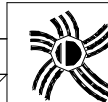

DEREN
SHENZHEN DEREN ELECTRONIC CO., LTD

CUSTOMER DRAWING		DATE		TITLE: WAFER MALE HOUSING 21.3H	
DRAW NO. ***		DESIGN: Yy_D	2023.03.14	P/N: SEE TABLE	
REV: 1		CHECK:		SHEET: 3/3	
APPROVAL:				SCALE: N/A	UNIT: mm

X-ON Electronics

Largest Supplier of Electrical and Electronic Components

Click to view similar products for [Headers & Wire Housings](#) category:

Click to view products by [DEREN](#) manufacturer:

Other Similar products are found below :

[0015917161](#) [0022155065](#) [57102-F02-18ULF](#) [58102-G61-06LF](#) [582553-1](#) [01.001.5753.1](#) [0050291907](#) [02.125.8002.8](#) [609-3404](#) [61062-3](#)
[CSU011177004](#) [622-0430](#) [622-3653LF](#) [63453-116](#) [636-1030](#) [636-1427](#) [636-3427](#) [636-4007](#) [641938-9](#) [65495-038](#) [65692-001LF](#) [65781-018](#)
[65781-047](#) [65817-010LF](#) [65817-015LF](#) [67095-007LF](#) [67601157](#) [68631-112](#) [699319-000](#) [70.362.1628.0](#) [70-4210](#) [70-4226B](#) [70-4853B](#) [707-](#)
[5028](#) [71.350.2428.0](#) [733-134](#) [733-162](#) [760-3052](#) [MHR-64-VUAL](#) [80.063.4001.1](#) [800-90-001-10-001000](#) [801-43-002-10-013000](#)
[801-43-006-10-002000](#) [803-43-024-10-001000](#) [803-93-012-10-001000](#) [8-1437020-4](#) [819-22-004-30-001101](#) [820-22-006-30-001101](#)
[820-22-008-30-001101](#) [821-22-002-10-001101](#)