

# 超高壓陶瓷電容器承認書

## APPROVAL SPECIFICATION

### FOR ULTRA-HIGH VOLTAGE TYPE CERAMIC CAPACITORS

客戶  
CUSTOMER

客戶料號  
CUSTOMER P/N

產品編碼  
PART NUMBER

CC4N151KE1JEB45MA100

規格描述  
DESCRIPTION

15KV/151/K/F10/直脚/L26/環氧(藍)/Y5P/5M/ZNR

日期  
DATE

2023/12/18

文件編號  
DOC. NO.

DEC-SA-WI002

德爾創承認欄 APPROVED BY DERSONIC			客戶承認欄 APPROVED BY CUSTOMER		
核 準 APPROVED BY	確 認 CHECK BY	制 訂 FORMULATE BY	核 準 APPROVED BY	確 認 CHECK BY	制 訂 FORMULATE BY
彭少雄	吳成愛	胡明表			

樣品承認章

東莞市德爾創電子有限公司  
DONGGUAN CITY DERSONIC ELECTRONICS CO., LTD.

廣東省東莞市寮步鎮松湖智谷產業園F2棟15樓

15/F, Blk F2, Songshan Lake Intelligent Valley Industrial Park, Liaobu Town, Dongguan City, PRC

TEL: 86-769-8155 5686

FAX: 86-0769-8155 5989

WEBSITE: HTTP://WWW.DERSONIC.COM

E-MAIL: QUALITY@DERSONIC.COM

請確保我們的產品已安裝到您的產品上前已根據您的規格進行了評估。

Please make sure that your product has been evaluated in view of your specifications with our product being mounted to your product.

請您使用我們的產品時，不要偏離此標準。

You are requested not to use our product deviating from this specification.

以下請參考！

Please refer to the following!

### I. 工作電壓

#### OPERATING VOLTAGE

在交流電路或紋波電路中使用直流額定電壓電容器時，請務必將外加電壓的 $V_{p-p}$ 值或包含直流偏置電壓的 $V_{o-p}$ 值維持在額定電壓範圍內。若嚮電路施加電壓，開始或停止時可能會因諧振或切換產生暫時的異常電壓。When DC- rated capacitors are to be used in AC or ripple current circuits, be sure to maintain the  $V_{p-p}$  value of the applied voltage or the  $V_{o-p}$  which contains DC bias within the rated voltage range. When the voltage is started to apply to the circuit or it is stopped applying, the irregular voltage may be generated for a transit period because of resonance or switching.

請務必使用額定電壓範圍包含這些異常電壓的電容器。

Be sure to use a capacitor within rated voltage containing these irregular voltages.

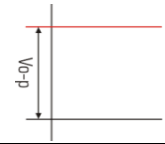
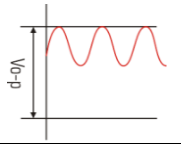
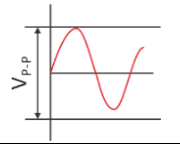
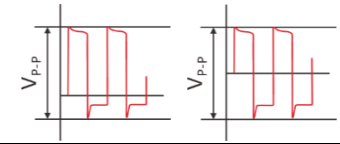
電壓 Voltage	直流電壓 DC Voltage	直流+交流電壓 DC+AC Voltage	交流電壓 AC Voltage	脈沖電壓 Pulse Voltage
測量位置 Positional Measurement				

### II. 工作溫度與自生熱

#### OPERATING TEMPERATURE AND SELF-GENERATED HEAT

電容器的表面溫度應保持在其額定工作溫度範圍的上限以下。務必考慮到電容器的自生熱。

Keep the surface temperature of a capacitor below the upper limit of its rated operating temperature range. Be sure to take into account the heat generated by the capacitor itself.

電容器在高頻電流、脈沖電流等中使用時可能會因介電損耗發出自生熱。外加電壓應使自生熱等負荷在25°C周圍溫度條件下不超過20°C範圍。測量時應使用 $\phi 0.1\text{mm}$ 小熱容量(K)的熱電偶，而且電容器不應受到其它元件的散熱或環境溫度波動影響。

When the capacitor is used in a high-frequency current, pulse current or the like, it may have the self-generated heat due to dielectric-loss.

Applied voltage should be the load such as self-generated heat is within 20°C on the condition of atmosphere temperature 25°C. When measuring, use a thermocouple of small thermal capacity-K of  $\phi 0.1\text{mm}$  and be in the condition where capacitor is not affected by radiant heat of other components and wind of surroundings.

過熱可能會導致電容器特性及可靠性下降。

Excessive heat may lead to deterioration of the capacitor's characteristics and reliability.

切勿在冷卻風扇運轉時進行測量。否則無法確保測量數據的精確性。

Never attempt to perform measurement with the cooling fan running. Otherwise, accurate measurement cannot be ensured.

### III. 貯存與使用條件

#### OPERATING AND STORAGE ENVIRONMENT

電容器絕緣包封層不是完美的密封形式，因此，請勿將電容器存放在腐蝕性氣體中，尤其是存在氯氣、硫氣、酸、堊、鹽等場所，同時應防潮。

The insulating coating of capacitors does not form a perfect seal; therefore, do not use or store capacitors in a corrosive atmosphere, especially where chloride gas, sulfide gas, acid, alkali, salt or the like are present. And avoid exposure to moisture.

在對本產品進行清洗、焊接或成型前，請先在指定設備上測試經清洗、焊接或成型的產品的性能，以確定上述過程不會影響產品質量。

In case of cleaning, bonding, or molding this product, verify that these processes do not affect product quality by testing the performance of a cleaned, bonded or molded product in the intended equipment.

電容器應存放在溫度及相對濕度分別不超出-10~40°C及15~85%範圍的場所。

Store the capacitors where the temperature and relative humidity do not exceed -10 to 40°C and 15% to 85%.

請在6個月內使用電容器。

Use capacitors within 6 months after delivered.

#### IV. 壓焊、樹脂塗層與包封

BONDING, RESIN MOLDING AND COATING, BOARD TO AVOID

在壓焊、樹脂塗層和封膜之前，請先使用指定設備確認對產品沒有影響，然後再進行使用。

In case of bonding, molding or coating this product, verify that these processes do not affect the quality of capacitor by testing the performance of the bonded, molded or coated product in the intended equipment.

在粘合、樹脂塗層、封膜的乾燥、硬化條件使用到有機溶劑（乙酸乙酯、甲基乙酮、甲苯等），可能會破壞電容器的包封樹脂，而造成短路不良。

In case of the amount of applications, dryness / hardening conditions of adhesives and molding resins containing organic solvents (ethyl acetate, methyl ethyl ketone, toluene, etc.) are unsuitable, the outer coating resin of a capacitor is damaged by the organic solvents and it may result, worst case, in a short circuit.

粘合、樹脂塗層、封膜厚度的偏差可能會在冷卻與加熱過程中使電容器的包封樹脂和/或陶瓷介質破裂。

The variation in thickness of adhesive, molding resin or coating may cause a outer coating resin cracking and/or ceramic element cracking of a capacitor in a temperature cycling.

樹脂材料在熱條件下（超過100°C）的強度較弱。因此，在這種情況下，為了避免機械應力，請小心處理。

Resin material to hot conditions (over 100°C) was weaker to intensity. So such with board to avoid mechanical stress in this state, please handle it with care.

#### V. 振動與碰撞

VIBRATION AND IMPACT

使用時請勿使電容器受到過度沖擊或振動。

Do not expose a capacitor or its leads to excessive shock or vibration during use.

#### VI. 焊錫

SOLDERING

當在PCB/PWB焊錫這個產品時，不要超過電容器的焊錫耐熱性標準。過度的熱量會使電容器內部焊錫熔化，可能導致熱沖擊而使陶瓷介質出現暗裂。

When soldering this product to a PCB/PWB, do not exceed the solder heat resistance specification of the capacitor. Subjecting this product to excessive heating could melt the internal junction solder and may result in thermal shocks that can crack the ceramic element.

右圖是推薦的波峰焊曲線，請參考！

On the right is the recommended wave-soldering curve, please refer to!

使用烙鐵進行手工焊錫時，應該遵照下列條件：

When soldering capacitor with a soldering iron, it should be performed in following conditions.

- 焊錫溫度：350°C最大  
Temperature of iron-tip: 350 °C max.
- 烙鐵頭：不超過40W  
Soldering iron wattage: 40W max.
- 焊錫時間：不超過5.0秒  
Soldering time: 5.0s max.

溫度  
Temperature (°C)

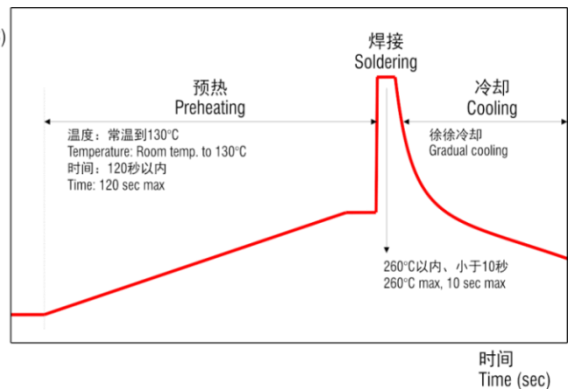

使用本產品時如忽略上述警告事項，則在嚴重情況下可能導致短路，並引起冒煙或局部破裂。

Failure to follow the above cautions may result, worst case, in a short circuit and cause fuming or partial dispersion when the product is used.

#### VII. 清洗

CLEANING

要進行超聲波清洗，應遵守下列條件。

To perform ultrasonic cleaning, observe the following conditions.

- 清洗槽容量：每升輸出功率小於20W。  
Rinse bath capacity : Output of 20 watts per liter or less.
- 清洗時間：最多5分鐘。  
Rinsing time: 5min maximum
- 不得直接振動 PCB/PWB。  
Do not vibrate the PCB/PWB directly.
- 過度的超聲波清洗會導致導線的過載損壞。  
Excessive ultrasonic cleaning may lead to fatigue destruction of the lead wires.

### VIII. 電容器容量變化

#### CAPACITANCE CHANGE OF CAPACITOR

##### ■ 1類瓷電容器

Class 1 capacitors

電容量可能會因環境溫度或外加電壓而發生輕微變化。若要將本產品用於嚴格的時間常數電路，請與我公司聯系。

Capacitance might change a little depending on a surrounding temperature or an applied voltage. Please contact us if you use for the strict time constant circuit.

##### ■ 2類瓷電容器

Class 2 capacitors

2類瓷像Y5P、Y5U和Y5V等溫度特性具有老化特性，因此，電容器若長時間不使用，其電容量會逐漸降低。而且，電容量還可能會因周圍溫度或外加電壓而發生巨大變化。所以不適合用於時間常數電路。若需詳情，請與我公司聯系。

Class 2 capacitors like temperature characteristic Y5P, Y5U and Y5V have an aging characteristic, whereby the capacitor continually decreases its capacitance slightly if the capacitor leaves for a long time. Moreover, capacitance might change greatly depending on a surrounding temperature or an applied voltage. So, it is not likely to be able to use for the time constant circuit. Please contact us if you need a detail information.

### IX. Y5P/Y6P工作电压与频率特性图(仅供参考)

Y5P / Y6P operating voltage and frequency characteristic curves (for reference)

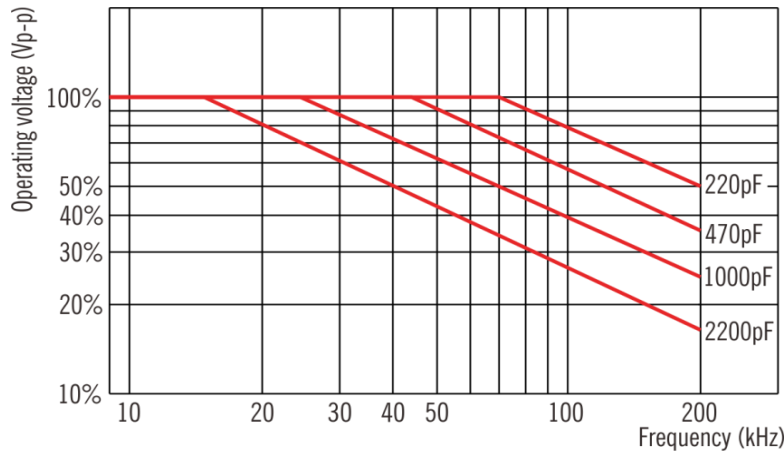

### 1. 規格表 DATA SHEET

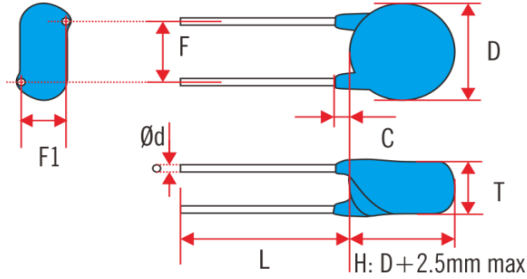

標誌 Marking: ZNR  
151K  
15KV

a) "ZNR" is DERSONIC registered trademark

- Comply with RoHS 2.0
- Halogen-free
- Comply with REACH

包封層: Coating:	環氧樹脂(藍色, UL94 V-0) Epoxy resin (Blue, UL94 V-0)
導線: Lead wire:	鍍錫銅線 Tin plated copper wire
腳型: Lead style:	直腳 Straight Lead

產品品號 PART NUMBER	CC4N151KE1JEB45MA100	
客戶品號 CUSTOMER P/N		
產品類別 PRODUCT SUBCLASS	Hi-k type	
額定電壓 RATED VOLTAGE	15KVDC Remark: Rated ac voltage (50/60Hz) $\approx$ 280% rated dc voltage, e.g.: Rated dc voltage 12000V $\approx$ rated ac voltage 4290V Rated dc voltage 15000V $\approx$ rated ac voltage 5360V Rated dc voltage 20000V $\approx$ rated ac voltage 7140V	
電容量 CAPACITANCE	150pF $\pm$ 10% @ 1kHz 1V 25°C	
損耗角正切 TANGENT OF LOSS ANGLE	0.015 max @ 1kHz 1V, 25°C	
耐電壓 TESTING VOLTAGE	NO FAILURE @ 22.5kVdc 3s, 2mA max (Please impregnate insulating oil, testing voltage at a rate not exceeding 5kV/s)	
絕緣電阻 INSULATION RESISTANCE	30G $\Omega$ min @ 1000V 60s, $\leq$ RH70%	
溫度特性 TEMPERATURE CHARACTERISTIC	Y5P ( $\Delta$ C/C: $\pm$ 10% @ -30°C~105°C)	
工作溫度範圍 OPERATING TEMPERATURE RANGE	-30°C~105°C	
尺寸 DIMENSIONS	D (DIAMETER)	8.5 mm $\pm$ 1.5mm
	T (THICKNESS)	8.0 mm $\pm$ 1.0mm
	F (LEAD SPACING)	10.0 mm $\pm$ 1.5mm
	F1 (LEAD MALPOSED SPACING)	5.6 mm $\pm$ 0.8mm
	L (LEAD LENGTH)	26.0 mm $\pm$ 5.0mm
	ød (LEAD DIAMETER)	0.70 mm $\pm$ 0.10mm
	C (COATING ON LEADS)	3.0 mm max

### 2. 應用

#### APPLICATION

本產品適用於高壓旁路和耦合電路、高壓包、高壓發生器與升壓/倍壓模塊等，如：

Ideal for use on high voltage bypass and coupling circuit, high voltage package, high voltage pulse generator, boost / double voltage modul,

■ X射線安檢設備

X-ray security equipment

■ 激光脈沖、X光機、CT機等醫療設備

Laser pulse, X-ray machine, CT machine and other medical equipment

■ 高壓電源、儀器儀表、靜電噴塗設備、智能電網、空氣淨化器等

Hi-voltage power supply, instrumentation, electrostatic spraying equipment, smart grid, air purifier, etc.

### 3. 產品範圍

#### SCOPE

工作溫度範圍 Operating temperature range	-30°C ~ +105°C (Y5U: -30°C ~ +85°C)
電容器範圍 Capacitance range	100pF ~ 4 700pF
額定直流電壓 Rated dc voltage	6.3KV, 8KV, 10KV, 12KV, 15KV, 20KV, 25KV, 30KV
絕緣電阻 Insulation resistance	TC type: 200G Ω min @ 1000V Hi-k type: 100G Ω min (Y5U: 30G Ω min) @ 1000V
耐壓 Withstanding voltage	No failure @ 150% rated dc voltage
充放電試驗 Charge / discharge test	No failure @ 10000 times (applying rated voltage) charge / discharge testing
耐久性 Endurance	No failure @ 105°C, 100% rated dc voltage, 1000hrs or 75°C, 125% rated dc voltage, 240hrs
溫度特性 Temperature characteristic	Y5P, Y5U, N4700 (Customizable UJ, SL, DL and Y5V)

■ 典型直流偏置電壓曲線（供參考）

Typical DC bias voltage curve (for reference)

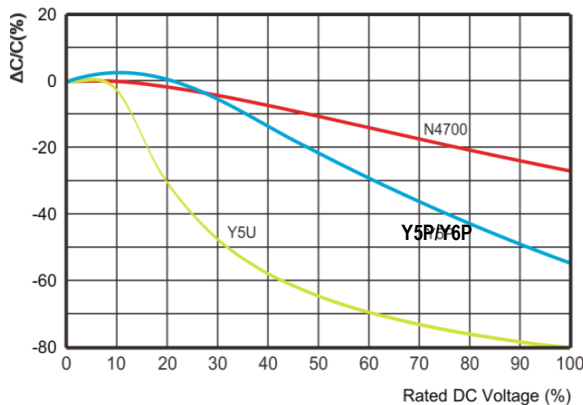

■ 典型溫度特性曲線（供參考）

Typical temperature characteristic curves (for reference)

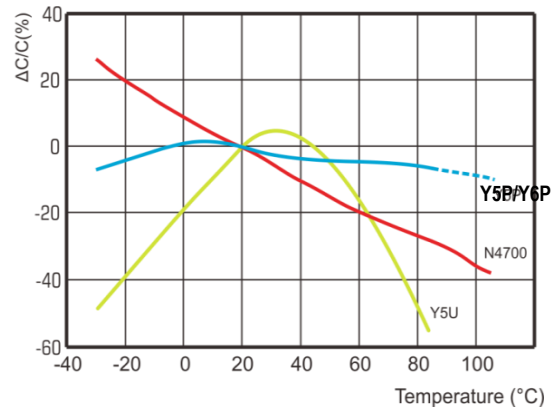

### 4. 品號組成

#### PART NUMBER CONFIGURATION

<b>CC</b>	<b>4N</b>	<b>151</b>	<b>K</b>	<b>E1J</b>	<b>E</b>	<b>B4</b>	<b>5MA100</b>
陶瓷電容 Disc ceramic capacitors	額定電壓 Rated voltage	標稱容量 Nominal capacitance	容量偏差 Capacitance tolerance	導線成型 方式 Lead format	包封 Coating	溫度特性 Temperature characteristic	內部生產碼 Internal production code
	15KV	150pF	±10%	F=10mm, L=26mm	Epoxy coating	Y5P	

### 5. 產品清單

#### SPECIFICATION LIST

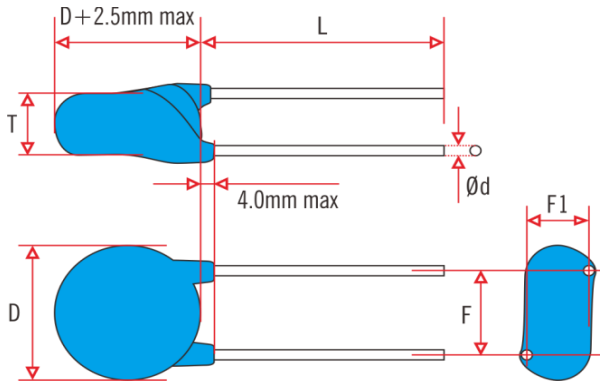

溫度特性 Temperature Characteristic		Y5P / Y6P (B4 / BX)				Y5U (E4)			N4700 (EM)			
額定電壓 Rated voltage		6.3KV	10KV	15KV	20KV	6.3KV	10KV	15KV	6.3KV	10KV	15KV	
尺寸 Dimensions (mm)	D, max	100pF	8.0	8.5	9.0	10.0	8.0	8.0	8.0	8.0	8.5	9.0
		150pF	8.0	8.5	10.0	11.0	8.0	8.0	8.0	8.0	9.0	10.0
		220pF	8.5	10.0	12.0	12.0	8.0	8.0	9.0	8.5	11.0	12.0
		330pF	9.5	11.0	13.0	14.0	8.0	8.5	10.0	10.0	12.0	13.0
		470pF	11.0	13.0	15.0	16.0	8.5	9.0	11.0	11.0	13.0	15.0
		680pF	12.0	15.0	17.0	19.0	9.0	10.0	12.0	12.0	15.0	17.0
		1000pF	14.0	17.0	20.0	22.0	10.0	11.0	14.0	13.0	18.0	20.0
		1500pF	17.0	20.0	24.0	25.0	11.0	13.0	16.0	15.0	21.0	24.0
	2200pF	20.0	24.0	28.0		13.0	15.0	18.0	18.0	24.0		
		3300pF					15.0	18.0				
	4700pF					18.0	21.0					
	6800pF											
	T, max	6	8	9	10	7	8	10	6	7	8	
	F, ±1.5	10	10	12.5	12.5	10	10	12.5	10	10	12.5	
	L, ±4.0	24	24	32	32	24	24	32	24	24	32	
	F1, ±1.0	2.8	3.8	5	6	3	4.5	6	2.2	3.2	4.5	
	Φd, ±0.1	0.6	0.6	0.8	0.8	0.6	0.6	0.8	0.6	0.6	0.8	
	包封層 Coating	環氧樹脂 (UL94 V-0) Epoxy resin (UL94 V-0)										

Note, The above specifications are designed based on the following conditions.

a) Withstanding voltage is 1.5 times the rated voltage,

b) The endurance is 100% rated voltage for 1,000 hours at the highest working temperature.

### 6. 標準和測試方法

#### SPECIFICATION AND TEST METHODS

試驗與測試必須在標準條件（溫度15~30°C，相對濕度45~75%）下進行。

Test and measurement shall be made at the standard condition (Temperature 15~35°C, relative humidity 45~75%).

除非另有說明，如果對測量結果有疑問和被特別要求的情況下，電容必須在基準條件（溫度25±2°C，相對濕度60~70%）下進行測試。

Unless otherwise specified herein. If doubt occurred on the value of measurement, and measurement was requested by customer capacitors shall be measured at the reference condition (Temperature 25±2°C, relative humidity 60~70%).

No.	項目 Item	標準 Specification	測試方法 Test method												
1	外觀 Appearance (APP)	外觀和尺寸沒有明顯的缺陷 No marked defect on appearance form and dimensions.	用目視檢查電容器表面明顯的缺陷 The capacitor should be inspected by naked eyes for visible evidence of defect.												
2	標誌 Marking	清晰易於識別 To be easily legible.	目視檢查。 The capacitor should be inspected by naked eyes.												
3	尺寸 Dimensions	請參考“規格表” Please refer to “Data sheet”.	用遊標卡尺測量。 Dimensions should be measured with slide calipers.												
4	耐壓 Withstanding voltage	引線 Between Lead wires (TV) 無失效 No failure	在絕緣油或氣體中，兩引線間施加下列指定的直流試驗電壓60秒鐘，電容器不應損壞（充放電流小於2mA）。 The capacitors shall not be damage when specified dc testing voltage of following is applied between the lead wires for 60 s in insulate liquid or gas. (Charge/discharge current: 2mA max.)  22.5KVDC (Testing voltage at a rate not exceeding 5kV/s)												
		本體 Body 無失效 No failure	將電容器放入填充滿直徑為1mm金屬球的容器中，然後將兩根引線短路，並且使電容器根部離金屬球2mm，如圖所示，在金屬與兩根引線之間施加3kV的直流電壓10s(充放電流小於2mA)。 The capacitors is placed in the container with metal balls of diameter 1mm so that each lead wires, short circuited, is kept about 2mm off the balls as shown in the figure, and DC voltage of 3kV is applied for 10 sec between capacitor lead wires and small metals. (Charge/discharge current: 2mA max.)												
5	絕緣電阻 Insulation resistance (IR)	30GΩ min	在電容器兩引線間施加1 000V的直流電壓，時間不大於60s。 The insulation resistance shall be measured with DC 1 000V within 60±5 s of charging.												
6	電容量 Capacitance	135PF-165PF	電容量、損耗應在25°C的環境下，使用指定的條件進行測試。 The capacitance and DF shall be measured at 25°C with specified condition.												
7	損耗因素 Dissipation factor (DF)	0.015 max													
8	溫度特性 Temperature characteristic	ΔC/C: ±10%	電容量應在表中規定的每個步驟進行測量。 The capacitance measurement shall be made at each step specified in table. <table border="1" style="margin: 10px auto;"> <thead> <tr> <th>Step</th> <th>1</th> <th>2</th> <th>3</th> <th>4</th> <th>5</th> </tr> </thead> <tbody> <tr> <th>Temp (°C)</th> <td>25</td> <td>-30</td> <td>25</td> <td>105</td> <td>25</td> </tr> </tbody> </table> 針對第3步驟的容量變化率不能超過指定值。 Capacitance change from the value of step 3 shall not exceed the limit specified.	Step	1	2	3	4	5	Temp (°C)	25	-30	25	105	25
Step	1	2	3	4	5										
Temp (°C)	25	-30	25	105	25										

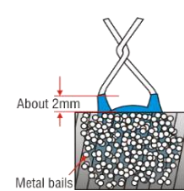



No.	項目 Item	標準 Specification	測試方法 Test method
9	充放電試驗 Charge, Discharge Test	APP 無可見損傷 No marked defect.	充電放電試驗應在下列試驗電路和循環中測量。 Charge discharge test shall be measured in the following test circuit and cycle.   E: Direct-current voltage source Co: Supplied energy for Cx (Cx ≠ Co) Cx: Specimen R1: Current protective resistor (300kΩ) R2: Current limiting resistor (E/10Ω)
		ΔC/C ±10%	
		DF 小於初始標準的2倍 Less than 200% initial specified value.	
		IR 大於初始標準的25% More than 25% initial specified value.	
		TV 如第4項進行試驗，沒有不合格 Per Item 4, No failure.	
10	導線抗張強度 Terminal Tensile Strength	導線無折斷，電容無破損。 Lead wire should not be cut off. Capacitor should not be broken.	固定電容器的本體，使電容器每支導線均承受10N垂直力，保持10±1秒鐘 Fix the body of capacitor, apply a tensile weight gradually to each lead wire in the radial direction of capacitor up to 10N, and keep it for 10±1 s.
11	導線抗折強度 Terminal Bending Strength	導線無折斷。 Lead wire should not be cut off.	電容器導線應承受5N重量，然後嚮外彎折成90°，然後回復到原來位置；接着往反方嚮彎折90°，再復原；彎折一次2-3秒鐘。 Each lead wire shall be subjected to 5N weight and then a 90° to bend, at the point of egress, in one direction, return to original position, and then a 90° bend in the opposite direction at the rate of one bend in 2 to 3 s.
12	可焊性 Solderability of Leads	導線必須有3/4以上的面積均勻附着焊錫。 Lead wire shall be soldered with uniformly coated on the axial direction over 3/4 of the circumferential direction.	將引線應浸入濃度為25%的乙醇溶液中，然後浸泡在熔融焊料中2±0.5秒鐘，浸泡深度為距引線根部約1.5至2.0mm處。 The lead wire shall be dipped into a 25% ethanol solution of rosin and then into molten solder of below temperature for 2±0.5 s. In both cases the depth of dipping is up to about 1.5 to 2.0mm from the root of lead wires. 焊錫溫度 Temp. of solder : 無鉛焊錫(Sn-3Ag-0.5Cu)245±5°C Lead Free Solder (Sn-3Ag-0.5Cu) 245±5°C
13	焊錫耐熱性 Soldering effect	APP 無可見損傷 No marked defect.	將引線浸泡在260±5°C的焊料中10±0.5秒鐘，其深度為距端子根部1.5至2.0mm處。 The lead wires shall be immersed into the melted solder of 260±5°C up to about 1.5 to 2.0mm from the main body for 10.0±0.5 s. 試驗後處理：電容器應在室溫下儲存1到2小時。 Post-treatment: Capacitor shall be stored for 1 to 2 h at room condition
		ΔC/C ±10%	

No.	項目 Item	標準 Specification	測試方法 Test method									
14	穩態濕熱 Humidity (under steady state)	APP 無可見損傷 No marked defect.	將電容器儲存溫度 $40 \pm 2^\circ\text{C}$ 、相對溫度為90~95%的環境中 $500 \pm 8$ 小時。 Set the capacitor for $500 \pm 8$ h at $40 \pm 2^\circ\text{C}$ in 90 to 95% humidity. 試驗後處理: 電容器應在室溫下儲存1到2小時。 Post-treatment: Capacitor shall be stored for 1 to 2 h at room condition.									
		$\Delta C/C$ $\pm 10\%$										
		DF 小於初始標準的2倍 Less than 200% initial specified value.										
		IR 大於初始標準的25% More than 25% initial specified value.										
15	壽命 Life (高溫負荷) (high temperature load)	APP 無可見損傷 No marked defect.	電容器浸入 $105^\circ\text{C} \pm 2^\circ\text{C}$ 絕緣油中, 施加1倍額定電壓 $1000 + 48/-0$ 小時(42天)。 Apply a DC voltage of 100% of the rated voltage for $1,000 + 48/-0$ h (42d) in insulating oil at $105^\circ\text{C} \pm 2^\circ\text{C}$ . 試驗後處理: 電容器應在室溫下儲存 $24 \pm 2$ 小時。 Post-treatment: Capacitor shall be stored for $24 \pm 2$ h at room condition.									
		$\Delta C/C$ $\pm 20\%$										
		DF 小於初始標準的2倍 Less than 200% initial specified value.										
		IR 大於初始標準的50% More than 50% initial specified value.										
		TV 如第4項進行試驗, 沒有不合格 Per Item 4.										
16	溫度循環 Temperature Cycling	APP 無可見損傷 No marked defect.	溫度循環試驗按以下條件進行試驗和測量 Temperature cycling shall be measured in the following test. <table border="1" data-bbox="890 1193 1356 1361"> <thead> <tr> <th>步驟 Step</th> <th>溫度 Temperature(<math>^\circ\text{C}</math>)</th> <th>時間 Time</th> </tr> </thead> <tbody> <tr> <td>1</td> <td>-30</td> <td>30 min</td> </tr> <tr> <td>2</td> <td>105</td> <td>30 min</td> </tr> </tbody> </table> 循環次數: 5次 Cycle numbers: 5 cycles 試驗後處理: 電容器應在室溫下儲存4小時。 Post-treatment: Capacitor shall be stored for 4 h at room condition.	步驟 Step	溫度 Temperature( $^\circ\text{C}$ )	時間 Time	1	-30	30 min	2	105	30 min
		步驟 Step		溫度 Temperature( $^\circ\text{C}$ )	時間 Time							
		1		-30	30 min							
		2		105	30 min							
		$\Delta C/C$ $\pm 10\%$										
DF 小於初始標準的2倍 Less than 200% initial specified value.												
IR 大於初始標準的25% More than 25% initial specified value.												
TV 如第4項進行試驗, 沒有不合格 Per Item 4.												

## X-ON Electronics

Largest Supplier of Electrical and Electronic Components

*Click to view similar products for [Ceramic Disc Capacitors](#) category:*

*Click to view products by [Dersonic](#) manufacturer:*

Other Similar products are found below :

[5AU100JCECA](#) [5AU220JCGCA](#) [5AU560JCJCA](#) [HCU180KBCDRTKR](#) [432202101621](#) [101GHR102K](#) [W1X223MCVCF0KR](#) [CC-100N](#)  
[NCD102K1KVY5FF](#) [NCD103M1KVZ5UF](#) [NCD331K1KVY5FF](#) [AOL-1502-02](#) [NCD103M1KVZ5UJTB](#) [DEF2CLH040CN3A](#)  
[F05B1B331KN0B0SHN0](#) [8903D0](#) [90410-10](#) [YV101103Z060HAND5P](#) [SL102101J060BAND5P](#) [YP202102K080D04A7H](#)  
[ZU501103M090B20C6P](#) [ZU102103M100X05B0P](#) [YP102271K050B20C6P](#) [YP102391K050BAND5P](#) [YP501101K040BAND5P](#)  
[ZU102103M100BAND5H](#) [YP102681K060B20C6P](#) [YP501121K040B20C6P](#) [SL102181J070HAND5P](#) [YP501471K040B20C6P](#)  
[SL102151J070HAND5P](#) [YP501102K050HAND5P](#) [ZU501102M050B20C6P](#) [YP501472K100B20C6P](#) [ZU102103M100B20C0P](#)  
[YV500223Z080HAND5P](#) [CC1H220KA1EDCH4B1100](#) [HGK3FE102MG3BW](#) [HGK3FF152MA3BW](#) [HGK3FE472MG3BW-3085A5](#)  
[HGK3AB271KG2BW](#) [SL500330J040B20C2P](#) [SL501510J050B20C6P](#) [SL102221J080HAND5P](#) [YP500103M100HAND5P](#)  
[YP102101K050B20C5B](#) [YP500472K070HAND5P](#) [SL102101J060HAND5H](#) [YP102222K080D20C5B](#) [LN202471K080D3EAEH](#)