

规格书
SPECIFICATION

客户 CUSTOMER	立创商场
客户料号 CUSTOMER P/N	
规格描述 DESCRIPTION	CL21系列
产品编码 PART NUMBER	
日期 DATE	2022-07-18

德尔创承认栏 APPROVED BY DERSONIC			客户承认栏 APPROVED BY CUSTOMER	
批准 APPROVED BY	审核 CHECK BY	制订 FORMULATE BY	批准 APPROVED BY	审核 CHECK BY
				

东莞市德尔创电子有限公司

DONGGUAN DERSONIC ELECTRONIC CO., LTD.

广东省东莞市长安镇锦厦河南工业区锦平路 5 号

No. 5, Jinping Rd., Jinxia Henan Industrial Zone, Changan Town, Dongguan City, PRC.

TEL: +86-769-8155 5686 FAX: +86-769-8155 5989

Website: <http://www.dersonic.com>

1. 规格尺寸

Specification & Dimensions

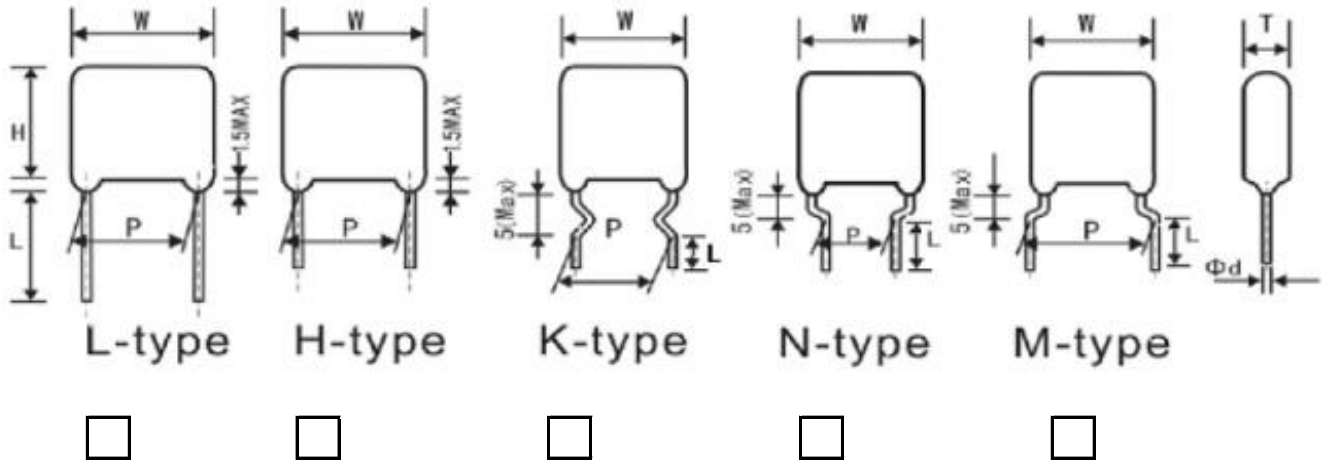

料号 P/N	立创编号	规格	外形尺寸 (单位: mm)					
			Dimensions and Drawings					
			W±1.0	H±1.0	T±1.0	Lmin	d±0.05	P±0.8
CFB2G104JE0603	C4945016	104J/400V	11.5	9.5	5.0	20	0.6	10.0
CFBGA104KD0323	C4945017	104K/125Vac	9.5	7.0	4.0	20	0.6	7.5
CFBGA224KE0324	C4945018	224K/125Vac	11.5	9.5	6.0	20	0.6	10.0

2. 产品介绍

Products Introduction

MPE/CL 电容是由金属化聚酯薄膜，采用无感结构卷绕而成，引线采用镀锡铜包钢线/镀锡铜线，外部使用阻燃环氧粉体封装而成。具有良好的自愈功能和优良的阻燃性，符合UL94-V0标准。

CL are wound with metallized polyester film dielectric, Non-inductive construction, tinned copper wire leads or tinned copper leads, and flame retardant epoxy resin coating. They have excellent features of self-healing and good flame retardant according to UL 94-V0

3. 产品结构和关键材料

Construction and main materials of products

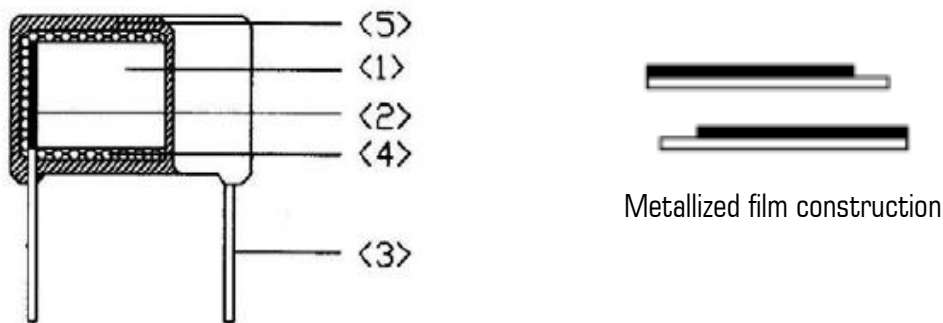

NO	关键材料Main Materials	材料规格 Specification	备注 Remark
1	金属化聚酯薄膜 Metallized polyester Film	MPEZAH or MPEA(4~12um)	...
2	锌锡层 Zn,Sn line	锌或锌锡合金 Zn or Zn and Sn alloy	...
3	导线 Terminal	镀锡铜包钢线(Φ0.6 or 0.8/1.0mm) CP or CU	镀锡层厚度7um以上
4	内封装材料 Inside Coating Material	环氧树脂 Epoxy resin	UL94-V0
5	外封装材料 Outside Coating Material	环氧粉末 Epoxy power	UL94-V0

注：以上材料均符合环保要求

Note: All of the Materials are in compliance with the requirements of ROHS AND REACH.

4. 典型应用

Type application

本产品适用于直流和VHF级信号的隔直流、旁路和耦合，广泛用于滤波，低脉冲电路。

The Products are suitable for blocking, by pass and coupling of DC and signals to VHF range, Widely used in filter and low pulse circuits.

5. 特点

Features

- 5.1 金属化聚酯膜, 无感结构 Metallized polyester film, Non-induction construction
- 5.2 容量范围宽, 体积小, 重量轻 Wide capacitance range, small size, and light weight
- 5.3 自愈性好, 寿命长 Long life due to Self-healing effect
- 5.4 阻燃性(符合UL 94V-0) Flame retardant type (compliance with UL 94V-0)
- 5.5 优秀的容量, 损耗的频率和温度特性 Excellent capacitance and DF for frequency and temperature characteristics
- 5.6 高绝缘阻值 High insulation resistance

6. 电气特性

Electrical specifications

如无其他说明, 电气特性请参考IEC 60384-2(GB7332)

Unless otherwise specified, electric characteristics shall refer to IEC 60384-2(GB7332)

项目 Item	特性要求 Characteristic requirement				测试方法及条件 Test method & Condition			
工作温度 Operating Temperature	-40°C ~ +125°C 在温度85°C (AC form 75°C) 以上时, 每上升1度, 额定电压下降1.25% +85°C ~ +125°C (AC FROM 75°C): derating factor 1.25% per °C for R.V(DC)							
容量范围 Capacitance Range	0.01μF ~ 10.0μF				1KHz, 1.0Vrms, 20°C			
容量偏差 Capacitance Tolerance	±1% (F), ±2% (G), ±2.5% (H), ±3% (I), ±5% (J), ±10% (K)				1KHz, 1.0Vrms, 20°C			
额定电压 Rated Voltage	100/125VAC/250/400 (250VAC) /450/630V							
损耗角正切 Dissipation Factor		$C \leq 0.1 \mu F$	$0.1 \mu F < C \leq 1.0 \mu F$	$C > 1.0 \mu F$	1KHz, 1.0Vrms, 20°C			
	1KHZ	0.80%	0.80%	1.00%				
	10KHZ	1.50%	1.50%					
	100KHZ	3.00%						
绝缘阻值 Insulation Resistance		$C \leq 0.33 \mu F$	$C \geq 0.33 \mu F$	100VDC, 60S, 20°C				
	$U_r \leq 100V$	$IR \geq 15000M\Omega$	$IR \geq 5000s$					
	$U_r > 100V$	$IR \geq 30000M\Omega$	$IR \geq 10000s$					
端子间电压 Withstand voltage Between Terminals	应无永久性击穿或飞弧 No permanent breakdown or flashover				1.6Ur(d.c) 60s; 2Ur(d.c) 5s C > 1μf, Cut off Current 10mA, C ≤ 1μf, Cut off Current 5mA, ARC=OFF, Voltage raising time 5 ~ 10s, for voltage rise AC: 15V/S; DC: 25V/S pulse rise ≤ 15v/us			
最大脉冲爬升速率 Maximum Pulse rising gradient(dv/dt)	Ur(V)	dv/dt(V/us)						
		P=5/7.5	P=10.0	P=15.0	P=20.0/22.5	P=27.5/25.0	P=31.5	P=37.5
	50/63V	4	3	1.5	1	1		
	100V	8	6	3	2	1		
	250V	13	11	7	5	3	2	
	400/450V	22	20	10	6	5	4	
630V		30	15	10	7.5	5		

容许单个尖峰值(脉冲)电流值 Permissible current value; $I(Ao-P) = C(U_f) \cdot dv/dt (v/us)$;
若连续的尖峰值电流值应用于重复或频繁出现的脉冲情形, 要按其峰值的0.4倍率设定, 较为安全。

说明 NOTE:

1. 若实际工作电压 (U) 比额定电压(Ur) 低, 电容器可工作在更高的dv/dt 场合, dv/dt 最大值应为上表值乘以(Ur/U).

1.If the working voltage (U) is lower than the rated voltage(Ur),the capacitor can be worked at a higher dv/dt. In this case,the maximum allowed dv/dt is obtain by multiplying the above value with Ur/U.

注: 额定电压定义: 在工作温度范围内, 电容持续运行的可承受电压. 但是, 工作温度在85℃~125℃之间时(AC form 75℃), 每上升1℃, 额定工作电压应下降1.25%。

Note:Rated voltage is defined the voltage which shall be capable of applying to capacitors continuously in the operating temperature range.However,rated voltage shall be derated 1.25% per °C when capacitors operation temperature is between 85°C to 125°C (AC from 75°C).

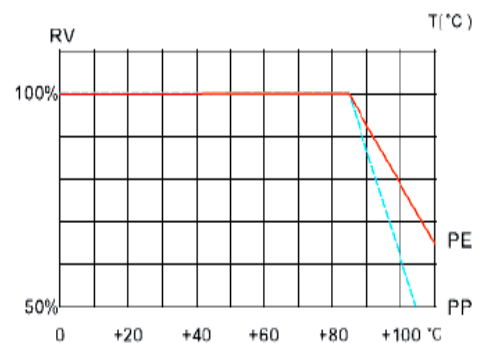

注: 电容器工作电压 (Operating voltage of the capacitor)

确认使用在电容器两个端子上的工作电压, 无论直流电压, 直流+交流电压, 交流电压, 脉冲电压, 均应在额定电压范围内。 Before using, make sure the voltage applied to the both ends of the capacitor is within the limit of the rated voltage,however DC voltage,DC and AC voltage,AC voltage,Pulse voltage etc.

Voltage	(1) DC voltage	(2) DC+AC voltage	(3) AC voltage
Positional Measurement (Rated voltage)			

Voltage	(4) Pulse voltage (A)	(5) Pulse voltage (B)
Positional Measurement (Rated voltage)		

注: 电容器使用工作温度范围 Capacitor working temperature range

确认电容器使用的温度 (环境温度+ 电容器自身表面温升+ 环境辐射温度), 不要超过其额定温度范围内。 Before using,please make sure the capacitor working temperature

(the ambient temperature+ capacitor's temperature+ temperature rise caused by environmental radiation temperature) is used should not exceed its rated temperature.在交流或高频脉冲线路中电容器由于电流通过而发热, 如果温升过高将会烧毁电容器。 The capacitors used in AC or high frequency pulse circuit emit heat due to the current flowing through ,if the temperature is too high will burn up capacitors.

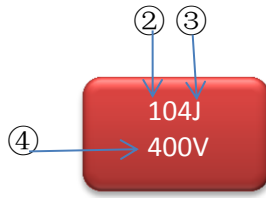

7. 印字 Marking

- (1) 商标 logo: ZNR
- (2) 静电容量 Capacitance: 104,224
- (3) 允许误差 Capacitance Tolerance : $\pm 5\%$ (J)
- (4) 额定电压 Rated Voltage : 50/63/100/250/400/450/630V

8. 电流对频率特性

Arms Vs Frequency

A permissible current is regulated by both a root-mean-square value current and a peak current.

A root-mean-square value current is to be a permissible current value to frequency attached.

The values of continuous peak current in the allowable peak current shall be those of continuous current,

And the values of single peak current shall be those of discontinuous current such as rush current in

Switching on or off. The highest number of times of single peak current shall be limited to 10,000times.

(In case of exceeding 10,000times, please contact us.)

允许电流通常由均方根电流和尖峰电流表示。

均方根电流（等效电流）如下附图所示

允许尖峰电流中的连续尖峰电流值应为持续电流，

单个尖峰电流应为不连续电流，如开关动作中的脉冲电流。

最高次数的单峰电流次数应限制在10000次内(若有超过10000次，请告知我们)。 Characteristics of permissible current (Arms)Vs Frequency - (sinusoidal wave , $\Delta T \leq 12^\circ\text{C}$) 允许电流 (**Arms**) 对频率特性曲线图 (正弦波, $\Delta T \leq 12^\circ\text{C}$)

50/63/100V

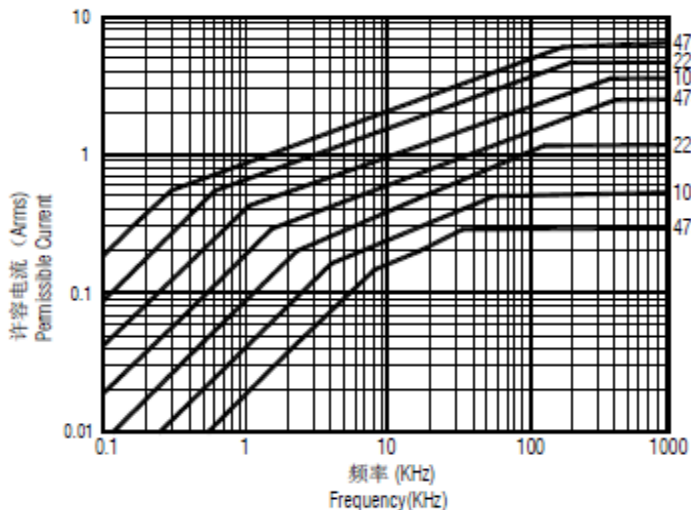

250V

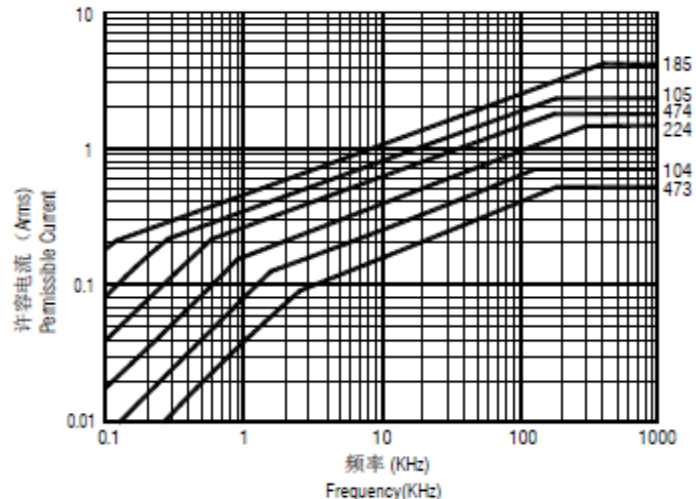

Characteristics of permissible current (Arms) Vs Frequency

电流Vs频率特性图

允许电流 (Arms) 对频率特性曲线图 (正弦波 , $\Delta T \leq 12^\circ\text{C}$)

400V

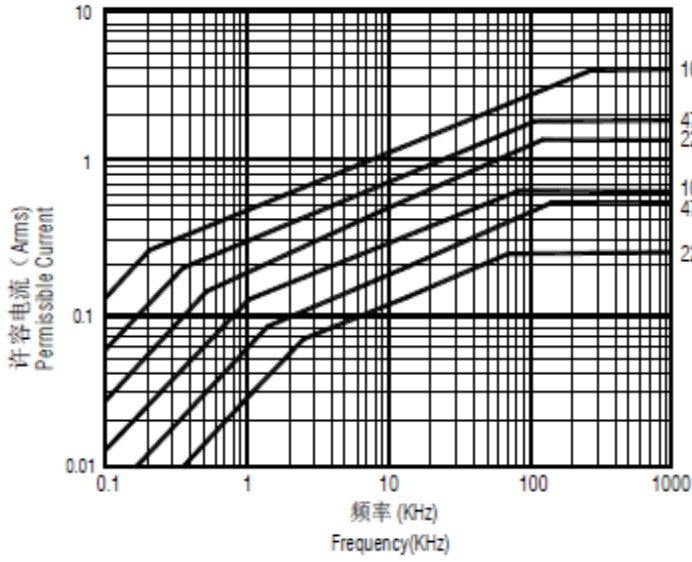

450V

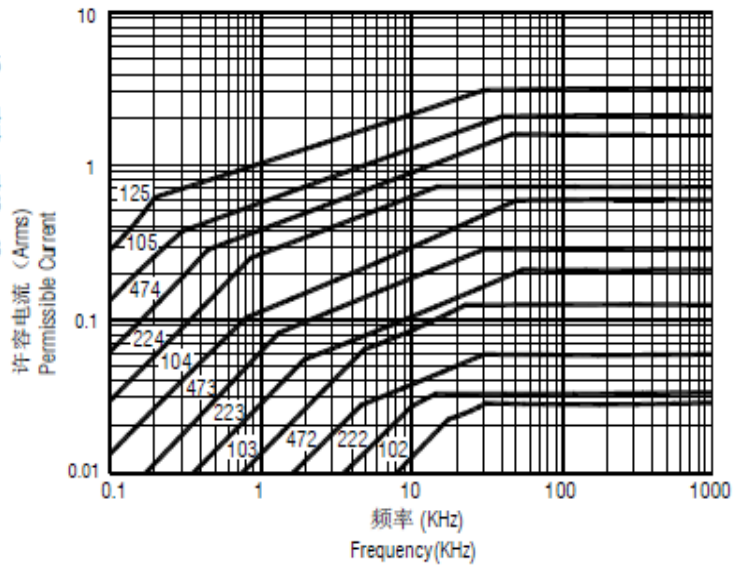

允许电流 (Arms) 对频率特性曲线图 (正弦波 , $\Delta T \leq 12^\circ\text{C}$)

630V

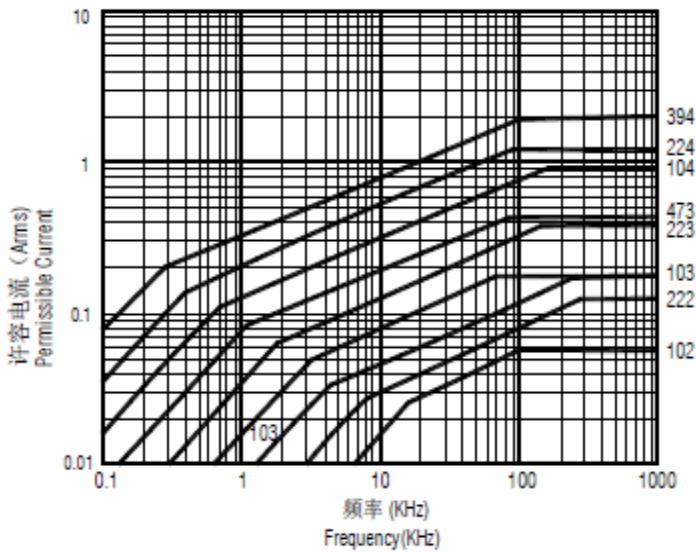

9. 温度特性

TEMPERATURE CHARACTERISTICS

CHARACTERISTICS

TYPICAL GRAPHS

TEMPERATURE CHARACTERISTICS

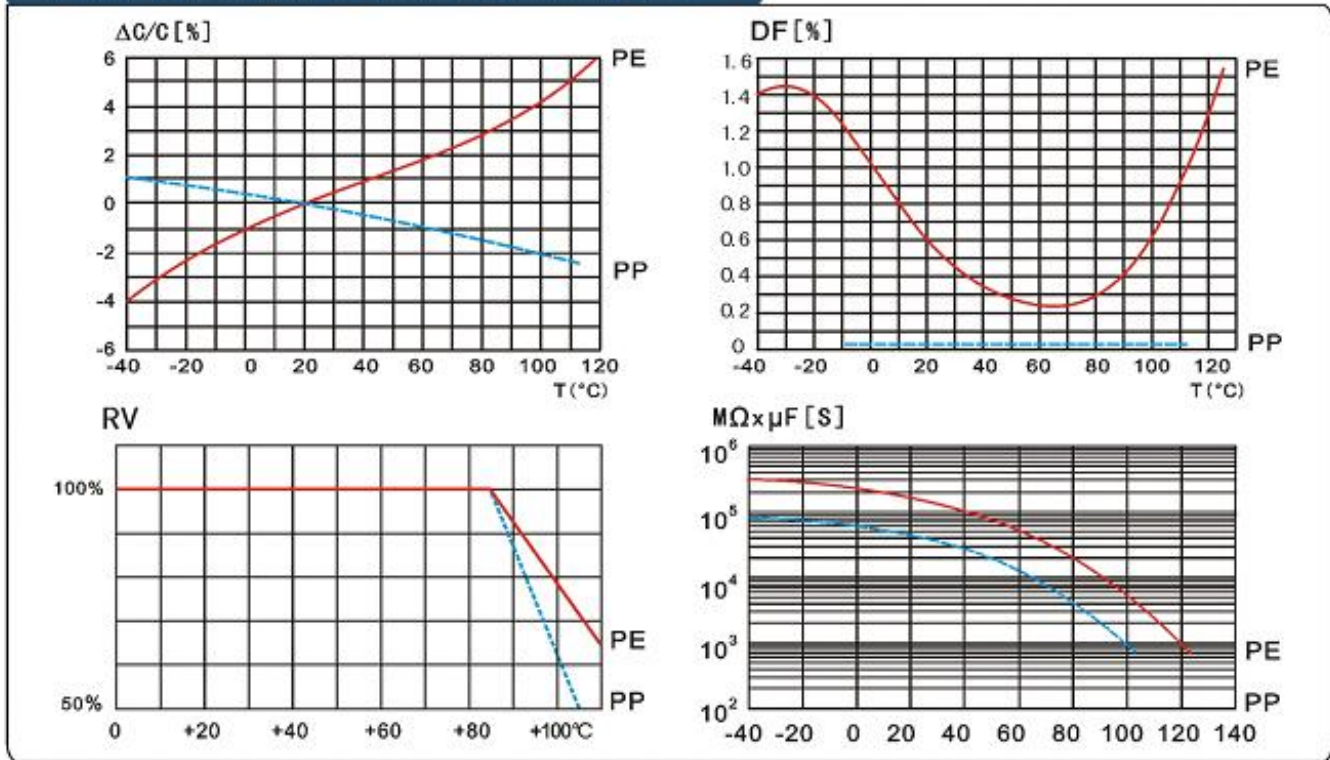

SOLDERING TEMPERATURE VS. TIME

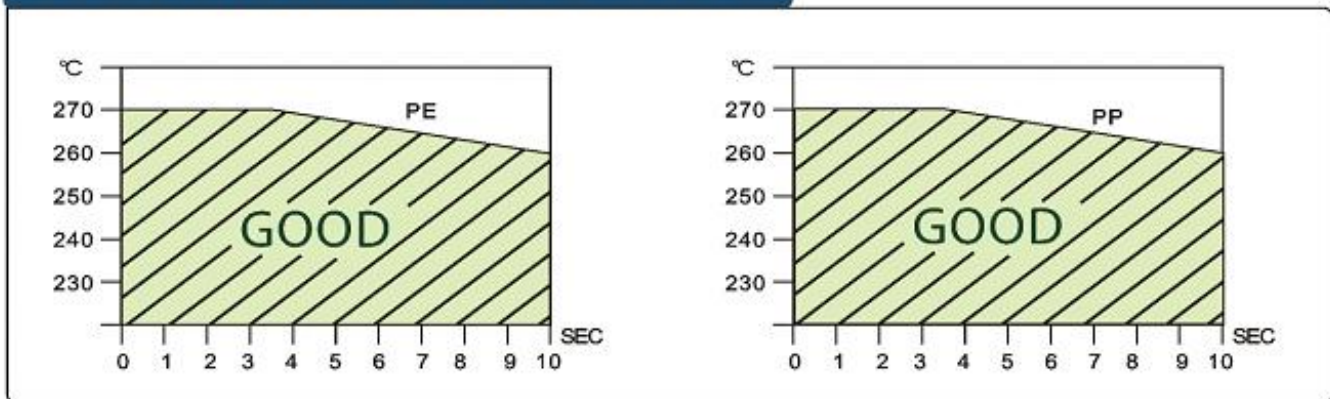

FREQUENCY CHARACTERISTICS

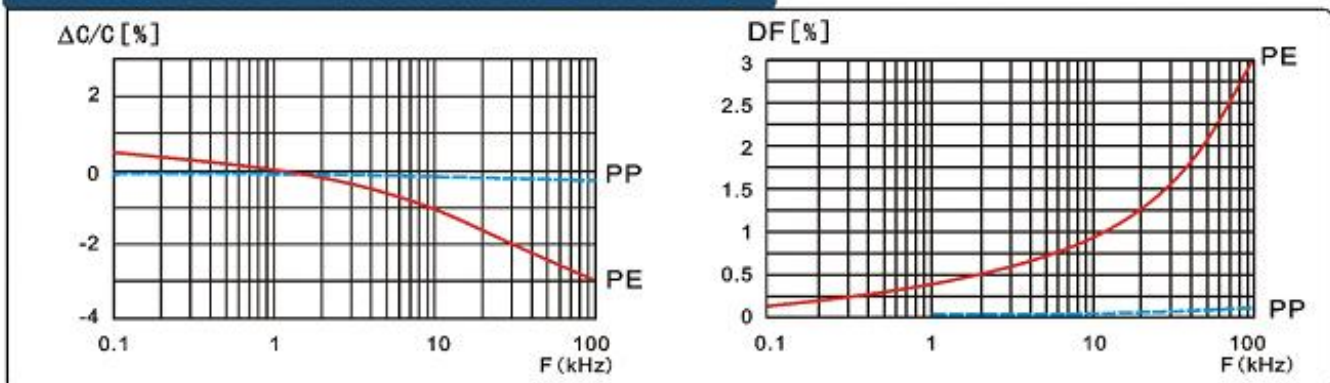

10. 使用指导

Guide in useage

10.1 焊锡

Soldering

当焊接电容器时，焊锡热会通过引线端子和封装层传递到电容素子，因此必须注意高温和长时间焊接引起的电容电气特性衰减或包封层损坏。请确认焊锡在以下温度范围内。

When soldering a capacitor, heat in soldering is conducted to the element of the capacitor from wire lead and an enclosure, and hence it should be noted that soldering under high temperature and long period may cause deterioration of characteristic or coating breakdown of capacitors.

Be sure to solder within the following temperature condition range.

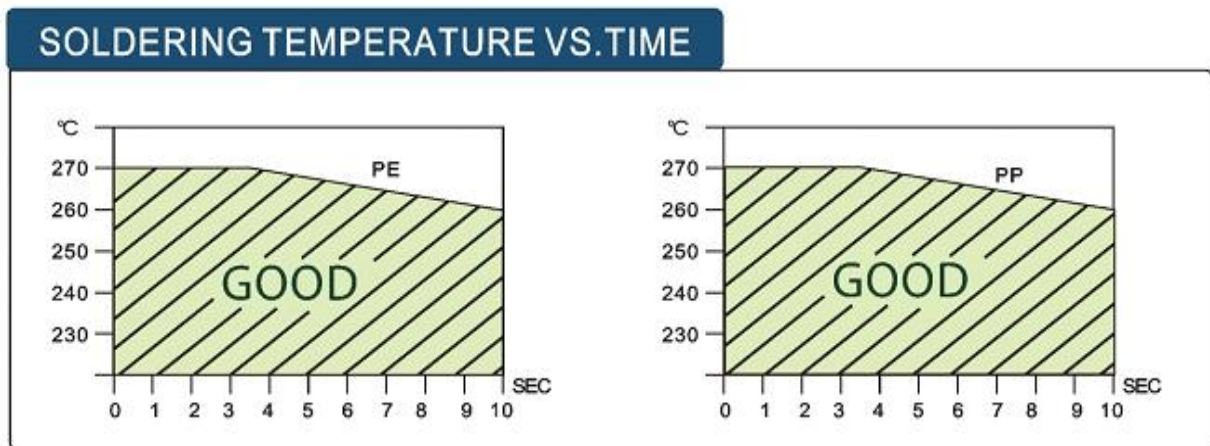

10.2 流焊/波峰焊

FLOW / WAVE SOLDERING

PRODUCTS: FILM CAPACITORS (Application of Through-Hole)

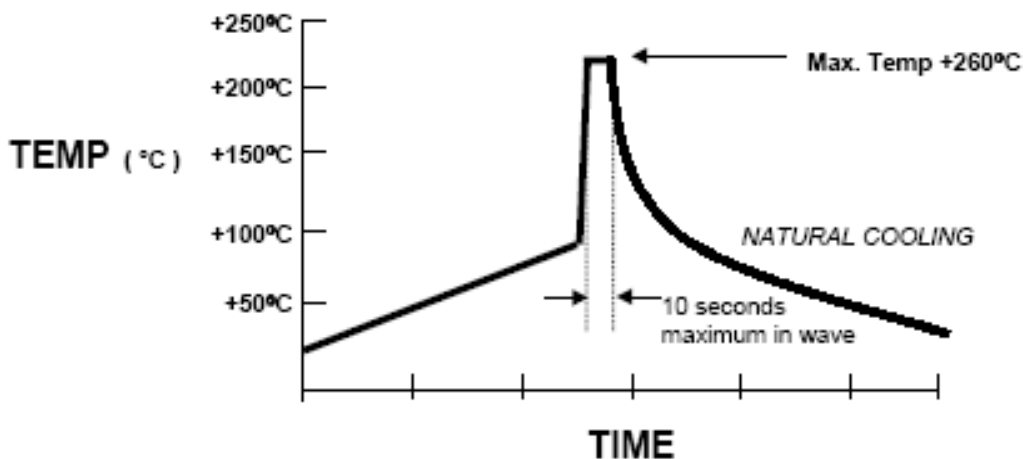

10.3 烙铁焊接

soldering iron

当使用烙铁焊接时，烙铁尖端温度不得超过350°C，焊接时间不超过5秒

When using soldering iron, iron tip temperature less than 350 °C, Soldering time(sec.) within 5 seconds.

11. 环保要求

Environment requirement

11.1 符合ROHS要求 Compliance with the requirement of ROHS

11.2 符合REACH要求 Compliance with the requirement of REACH.

11.3 符合无卤（如要求） Without Halogen(as required).

12. 参考标准

Reference standards

GB-T2693-2001 (IDT IEC 60384-1-2008) 电子设备用固定电容器 第1部分 总规范

GB-T7332-1996 电子设备用固定电容器 第2部分 分规范 金属化聚乙烯对苯二甲酸酯膜介质直流固定电容器

IEC-60384-2-2005 电子设备用固定电容器 第2部分 分规范 金属化聚乙烯对苯二甲酸酯膜介质直流固定电容器

GB-T 2828.1-2003 计数抽样检验程序 第1部分 按接收质量限(AQL)检索逐批检验抽样计划

GB-T2693-2001 (IDT IEC 60384-1-2008) *Fixed capacitors for use in electronic equipment –Part 1: Generic specification*

GB-T7332-1996 *Fixed capacitors for use in electronic equipment Part2:Sectionals pecification Fixed metallized polyethylene terephthalate film dielectric d.c. capacitors*

IEC-60384-2-2005 *Fixed capacitors for use in electronic equipment Part 2:Sectional specification:Fixed metallized polyethylene-terephthalate film dielectric d.c. capacitors*

GB-T 2828.1-2003 Sampling procedures for inspection by attributes—Part 1:

Sampling schemes indexed by acceptance quality limit (AQL)for lot-by-lot inspection

(ISO 2859-1:1999, IDT)

13. 包装Packing

13.1 散装



塑料袋最小包装，数量为100、200、500、1000PCS

Plastic bag is the minimum packing.the quantity are 100 、 200 、 500 、 1000PCS.袋内放置产品合格环保标识标签，包括料号，规格，数量，LOT批号，生产日期等The label of the ROHS include the product name 、 specification 、 quantity 、 lot No 、 manufacture date etc.

13. 2编带装

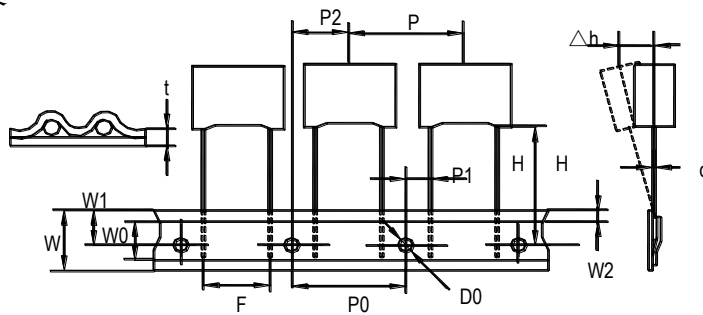

Fig. 1 Pitch=5 and 7.5mm

Description	Letter	Dimension (mm)				Tol.
		Fig. 1 P=5mm	Fig.1/ Fig.2 P=7.5mm	Fig.3 P=10mm	Fig.3 P=15mm	
Lead wire diameter	d	0.5/0.6	0.5/0.6	0.6	0.6/0.8	±0.05
Taping pitch	P	12.7	12.7	25.4	25.4	±1
Feed hole pitch	PO	12.7	12.7	12.7	12.7	±0.2
Centering of the	P1	3.85	2.6/3.75	7.7	5.2	±0.7
Centering of the	P2	6.35	6.35	12.7	12.7	±1.3
Lead spacing (pitch)	F	5	7.5	10	15	+0.6; -0.1
Component	Δh	0	0	0	0	±2
Height of	H	18.5	18.5	18.5	18.5	±0.5
Carrier tape width	W	18	18	18	18	+1; -0.5
Hold down tape	W0	6	6	9	10	min
Hole position	W1	9	9	9	9	±0.5
Hold down tape	W2	3	3	3	3	max
Feed hole diameter	Do	4	4	4	4	±0.2
Tape thickness	t	0.7	0.7	0.7	0.7	±0.2

Remark: *Allowance of accumulated pitch less than 1mm at the sum of 20 pitches.

*Continuous empty component less than 3 pcs.

*Total empty on one reel less than 1%.

PACKING SPECIFICATIONS

PACKING TYPE	REEL PACKING		AMMO BOX PACKING	
DIMENSIONS UNIT:MM	A	14~30	A	50 ⁺⁵ / ₋₂
	B	80 MIN	B	260 ± 2
	D	370 MAX	C	330 ± 2
	W1	45 ⁺⁵ / ₋₂		
	W2	55MAX		
PACKING QITY PER REE/BOX	C ≦ 0.022 1500 PCS	C > 0.022 1000 PCS	C ≦ 0.047 1500 PCS	C > 0.047 1000 PCS

14. 存储条件

Storage conditions

14.1 请注意，长时间产品暴露在空气中会导致引线氧化，焊接性能衰减。

It should be noted that the solderability of the terminals may be deteriorated when stored barely in an atmosphere for a long periods

14.2 不能放置在高温高湿环境中，请遵循以下存储条件（原包装下保存）

It shouldn't be located in particularly high temperature and high humidity, it must submit to the following conditions(keeping in the original package)

温度 Temperature: 35 °C MAX

相对湿度 Relative humidity : 60% MAX

14.3 存储时间：最长12个月（以包装袋上标注的生产日期为准）

Storage period: 12 months max

(from the manufacturing date marked on the label in package bag)

15. 可靠性实验

Reliability test

15.1 测试条件：除非另有规定，所有试验和测量均应在GB2421—81第4.3条（IEC68 1第5.3条）中规定的试验用标准大气条件下进行，条件如下：

Test condition: Unless otherwise specified, all tests and measurements shall be made under standard atmospheric conditions for testing as given in GB2421-81 NO.4.3(IEC68-1 NO.5.3), AS follows

温度 Temperature : 15 °C — 35 °C

相对湿度 Relative humidity : 25% — 75%

气压 Air pressure : 86 — 106 Kpa (860 — 1060 mbra)

15.2 如对测试结果有任何疑问，则按以下限制测试：

If there may be any doubt on the results, measurements shall be made within the following limits.

环境温度 Ambient temperature: 20 ± 2 °C

环境湿度 Relative humidity: 50 ~ 70%

15.3 电性参数参考 IEC 60384-1:2008 , IEC 60384-2, IEC 60068-2-2; IEC 60068-2-21

Electric characteristics shall refer to IEC 60384-1:2008 , IEC 60384-2, IEC 60068-2-2; IEC 60068-2-21

15.4 电性参数

Electric characteristics

项目 Item	特性要求 Characteristic requirement				测试方法及条件 Test method&Condition
容量范围 Capacitance Range	0.01 μ F~10.0 μ F				IEC60384-2 4.2.2 IEC60384-1 4.7
容量偏差 Capacitance Tolerance	$\pm 1\%$ (F), $\pm 2\%$ (G), $\pm 2.5\%$ (H), $\pm 3\%$ (I), $\pm 5\%$ (J), $\pm 10\%$ (K)				1KHz, 1.0Vrms, 20 $^{\circ}$ C
额定电压 Rated Voltage	50/63/100/250/400(250VAC)/450/630V				
损耗角正切 Dissipation Factor		$C \leq 0.1 \mu F$	$0.1 \mu F < C \leq 1.0 \mu F$	$C > 1.0 \mu F$	1KHz, 1.0Vrms, 20 $^{\circ}$ C
	1KHZ	0.80%	0.80%	1.00%	
	10KHZ	1.50%	1.50%		
	100KHZ	3.00%			
绝缘阻值 Insulation Resistance		$C \leq 0.33 \mu F$	$C \geq 0.33 \mu F$		100VDC, 60S, 20 $^{\circ}$ C
	$U_r \leq 100V$	$IR \geq 15000M\Omega$	$IR \geq 5000s$		
	$U_r > 100V$	$IR \geq 30000M\Omega$	$IR \geq 10000s$		
端子间电压 Withstand voltage Between Terminals	应无永久性击穿或飞弧 No permanent breakdown or flashover				1.6Ur(d.c) 60s; 2Ur(d.c)5s C > 1 μ f, Cut off Current 10mA, C \leq 1 μ f, Cut off Current 5mA, ARC=OFF, Voltage raising time 5 ~ 10s, for voltage rise AC: 15V/S; DC: 25V/S pulse rise \leq 15v/us

15.5 寿命实验

Life Test

NO.	项目 Item	特性要求 Characteristic requirement	测试方法及条件 Test method&Condition		
1	端子强度 Terminal Strength	拉伸强度 Pull Strength There shall be no visible mechanical damage	线径mm	荷重	时间
			wire diameter	Load	Time
			≤ 0.5	5N	10S
			$0.5 < d \leq 0.8$	10N	10S
			$0.8 < d \leq 1.25$	20N	10S
			IEC60384-2 C4.3 IEC60384-1 C4.13 IEC60068 2-21 Test Ua1		
	端子强度 Terminal Strength	弯曲强度 Bending Strength There shall be no visible mechanical damage	线径mm	荷重	次数
			wire diameter	Load	Times
			≤ 0.5	5N	90 $^{\circ}$ C \times 4
			$0.5 < d \leq 0.8$	5N	90 $^{\circ}$ C \times 4
			$0.8 < d \leq 1.25$	5N	90 $^{\circ}$ C \times 4
			IEC60384-2 C4.3 IEC60384-1 C4.13 IEC60068 2-21 Test Ua1		

No.	项目 Item	特性要求 Characteristic requirement	测试方法及条件 Test method&Condition										
2	可焊性 Solderability	端子引线周围至少95%的面积均匀附锡，且本体无破裂等损坏现象 锡料成分Sn 97.5% + Ag 2% + Cu 0.5% At least 95% of the Circumference of the Lead wire.Around load surface dipped into with new soler, the body be no visible damage.	焊锡温度: 235±5℃ Solder temp 浸渍时间: 2.0±0.5S Immersion time IEC60384-2 C4.5 IEC60384-1 C4.15 IEC60068-2-20 Test Ta										
3	耐焊接热 Resistance to Soldering heat	<table border="1" style="width:100%; border-collapse: collapse;"> <tr> <td style="width:20%;">外观 Appearance</td> <td>无可见损伤,标志清晰 焊锡温度: 260±5℃ No visible damage , The marking shall be legible 。 Solder temp</td> </tr> <tr> <td>容量变化 Capacitance Variation</td> <td style="text-align:center;">$\Delta C/C \leq 2\%$</td> </tr> <tr> <td>损耗 Dissipation Factor</td> <td>$\Delta tg \delta \leq 0.005$ CR≤1.0μF at 10KHZ $\Delta tg \delta \leq 0.003$ CR>1.0μF at 1KHZ</td> </tr> <tr> <td>耐电压 Withstand Voltage</td> <td>1.6 UR (d.c) 60S耐电压后无击穿或飞弧 No permanent breakdown or flashover</td> </tr> <tr> <td>绝缘电阻 Insulation Resistance</td> <td style="text-align:center;">$\Delta R/R \leq 50\%$</td> </tr> </table>	外观 Appearance	无可见损伤,标志清晰 焊锡温度: 260±5℃ No visible damage , The marking shall be legible 。 Solder temp	容量变化 Capacitance Variation	$\Delta C/C \leq 2\%$	损耗 Dissipation Factor	$\Delta tg \delta \leq 0.005$ CR≤1.0μF at 10KHZ $\Delta tg \delta \leq 0.003$ CR>1.0μF at 1KHZ	耐电压 Withstand Voltage	1.6 UR (d.c) 60S耐电压后无击穿或飞弧 No permanent breakdown or flashover	绝缘电阻 Insulation Resistance	$\Delta R/R \leq 50\%$	浸渍时间: 10±1S Immersion time 恢复时间1-2小时 Then recovery at ordinary condition 1~2hours IEC60384-2 C4.4 IEC60384-1 C4.14 IEC60068-2-20 Test Ta
外观 Appearance	无可见损伤,标志清晰 焊锡温度: 260±5℃ No visible damage , The marking shall be legible 。 Solder temp												
容量变化 Capacitance Variation	$\Delta C/C \leq 2\%$												
损耗 Dissipation Factor	$\Delta tg \delta \leq 0.005$ CR≤1.0μF at 10KHZ $\Delta tg \delta \leq 0.003$ CR>1.0μF at 1KHZ												
耐电压 Withstand Voltage	1.6 UR (d.c) 60S耐电压后无击穿或飞弧 No permanent breakdown or flashover												
绝缘电阻 Insulation Resistance	$\Delta R/R \leq 50\%$												
4	耐久性 Endurance	<table border="1" style="width:100%; border-collapse: collapse;"> <tr> <td style="width:20%;">外观 Appearance</td> <td>无可见损伤,标志清晰 No visible damage , The marking shall be legible 。</td> </tr> <tr> <td>容量变化 Capacitance Variation</td> <td style="text-align:center;">$\Delta C/C \leq 5\%$</td> </tr> <tr> <td>损耗 Dissipation Factor</td> <td>$\Delta tg \delta \leq 0.005$ CR≤1.0μF at 10KHZ $\Delta tg \delta \leq 0.003$ CR>1.0μF at 1KHZ</td> </tr> <tr> <td>耐电压 Withstand Voltage</td> <td>1.6 UR (d.c) 60S耐电压后无击穿或飞弧 No permanent breakdown or flashover</td> </tr> <tr> <td>绝缘电阻 Insulation Resistance</td> <td style="text-align:center;">$\Delta R/R \leq 50\%$</td> </tr> </table>	外观 Appearance	无可见损伤,标志清晰 No visible damage , The marking shall be legible 。	容量变化 Capacitance Variation	$\Delta C/C \leq 5\%$	损耗 Dissipation Factor	$\Delta tg \delta \leq 0.005$ CR≤1.0μF at 10KHZ $\Delta tg \delta \leq 0.003$ CR>1.0μF at 1KHZ	耐电压 Withstand Voltage	1.6 UR (d.c) 60S耐电压后无击穿或飞弧 No permanent breakdown or flashover	绝缘电阻 Insulation Resistance	$\Delta R/R \leq 50\%$	温度Temp: 125±3℃ 持续时间: 1000+48h 施加电压voltage: 1.25 Ur(d.c).150hz 恢复时间至少16小时 Then recovery at ordinary condition at least 16 hours IEC60384-2 C4.12 IEC60384-1 C4.23 IEC60068-2-2
外观 Appearance	无可见损伤,标志清晰 No visible damage , The marking shall be legible 。												
容量变化 Capacitance Variation	$\Delta C/C \leq 5\%$												
损耗 Dissipation Factor	$\Delta tg \delta \leq 0.005$ CR≤1.0μF at 10KHZ $\Delta tg \delta \leq 0.003$ CR>1.0μF at 1KHZ												
耐电压 Withstand Voltage	1.6 UR (d.c) 60S耐电压后无击穿或飞弧 No permanent breakdown or flashover												
绝缘电阻 Insulation Resistance	$\Delta R/R \leq 50\%$												
5	稳态湿热 Damp heat, steady	<table border="1" style="width:100%; border-collapse: collapse;"> <tr> <td style="width:20%;">外观 Appearance</td> <td>无可见损伤,标志清晰 No visible damage , The marking shall be legible 。</td> </tr> <tr> <td>容量变化 Capacitance Variation</td> <td style="text-align:center;">$\Delta C/C \leq 5\%$</td> </tr> <tr> <td>损耗 Dissipation Factor</td> <td>$\Delta tg \delta \leq 0.005$ CR≤1.0μF at 10KHZ $\Delta tg \delta \leq 0.003$ CR>1.0μF at 1KHZ</td> </tr> <tr> <td>耐电压 Withstand Voltage</td> <td>1.6 UR (d.c) 60S耐电压后无击穿或飞弧 No permanent breakdown or flashover</td> </tr> <tr> <td>绝缘电阻 Insulation Resistance</td> <td style="text-align:center;">$\Delta R/R \leq 50\%$</td> </tr> </table>	外观 Appearance	无可见损伤,标志清晰 No visible damage , The marking shall be legible 。	容量变化 Capacitance Variation	$\Delta C/C \leq 5\%$	损耗 Dissipation Factor	$\Delta tg \delta \leq 0.005$ CR≤1.0μF at 10KHZ $\Delta tg \delta \leq 0.003$ CR>1.0μF at 1KHZ	耐电压 Withstand Voltage	1.6 UR (d.c) 60S耐电压后无击穿或飞弧 No permanent breakdown or flashover	绝缘电阻 Insulation Resistance	$\Delta R/R \leq 50\%$	温度Temp: 40±2℃ 湿度: 90-95%RH Humidity 持续时间: 56 day Duration 电容不施加电压 恢复时间1-2小时 Then recovery at ordinary condition 1-2 hours IEC60384-2 C4.11 IEC60384-1 C4.22 IEC60068-2-78 Test Cab
外观 Appearance	无可见损伤,标志清晰 No visible damage , The marking shall be legible 。												
容量变化 Capacitance Variation	$\Delta C/C \leq 5\%$												
损耗 Dissipation Factor	$\Delta tg \delta \leq 0.005$ CR≤1.0μF at 10KHZ $\Delta tg \delta \leq 0.003$ CR>1.0μF at 1KHZ												
耐电压 Withstand Voltage	1.6 UR (d.c) 60S耐电压后无击穿或飞弧 No permanent breakdown or flashover												
绝缘电阻 Insulation Resistance	$\Delta R/R \leq 50\%$												

NO.	项目 Item	特性要求 Characteristic requirement	测试方法及条件 Test method&Condition
6	干热 Dry heat	外观 Appearance 无可见损伤,标志清晰 No visible damage , The marking shall be legible 。 容量变化 Capacitance Variation $\Delta C/C \leq 5\%$ 损耗 Dissipation Factor $\Delta \text{tg} \delta \leq 0.005$ $CR \leq 1.0 \mu F$ at 10KHZ $\Delta \text{tg} \delta \leq 0.003$ $CR > 1.0 \mu F$ at 1KHZ 耐电压 Withstand Voltage 1.6 UR (d.c) 60S耐电压后无击穿或飞弧 No permanent breakdown or flashover 绝缘电阻 Insulation Resistance $\Delta R/R \leq 50\%$	温度Temp: $125 \pm 2^\circ C$ 持续时间: 16h Duration 恢复时间不低于4小时 Then recovery at ordinary condition at least 4 hours IEC60384-2 C4.10.2 IEC60384-1 C4.21.2 IEC60068-2-2, test Bb
7	寒冷 Cold	外观 Appearance 无可见损伤,标志清晰 No visible damage , The marking shall be legible 。 容量变化 Capacitance Variation $\Delta C/C \leq 5\%$ 损耗 Dissipation Factor $\Delta \text{tg} \delta \leq 0.005$ $CR \leq 1.0 \mu F$ at 10KHZ $\Delta \text{tg} \delta \leq 0.003$ $CR > 1.0 \mu F$ at 1KHZ 耐电压 Withstand Voltage 1.6 UR (d.c) 60S耐电压后无击穿或飞弧 No permanent breakdown or flashover 绝缘电阻 Insulation Resistance $\Delta R/R \leq 50\%$	温度Temp: $-40 \pm 2^\circ C$ 持续时间: 4h Duration 恢复时间不低于4小时 Then recovery at ordinary condition at least 4 hours IEC60384-2 C4.10.4 IEC60384-1 C4.21.4 IEC60068-2-1, test Ab
8	浪涌 Surge	外观 Appearance 无可见损伤,标志清晰 No visible damage , The marking shall be legible 。 容量变化 Capacitance Variation 损耗 Dissipation Factor $\Delta \text{tg} \delta < 0.0080$ $CR \leq 1.0 \mu F$ $\Delta \text{tg} \delta < 0.0050$ $CR > 1.0 \mu F$ at 1KHZ 耐电压 Withstand Voltage 1.6 UR (d.c) 60S耐电压后无击穿或飞弧 No permanent breakdown or flashover 绝缘电阻 Insulation Resistance $\Delta R/R \leq 50\%$	When $CR \leq 1.0 \mu F$ $UP = 1.6UR$ When $CR > 1.0 \mu F$ $\Delta C/C \leq 5\%$ $UP = UR$ time:10s Cycle times:24次前三次脉冲没有发生自愈性击穿,则可停止,为合格 IEC60384-1 C4.26 IEC60060-1

NO.	项目 Item	特性要求 Characteristic requirement	测试方法及条件 Test method&Condition
9	充放电 Charge and discharge	外观 Appearance 容量变化 Capacitance Variation 损耗 Dissipation Factor 耐电压 Withstand Voltage 绝缘电阻 Insulation Resistance	无可见损伤,标志清晰 visible damage , The marking shall be legible 。 $\Delta C/C \leq 5\%$ $\Delta \text{tg} \delta \leq 0.005$ CR $\leq 1.0 \mu\text{F}$ at 10KHZ $\Delta \text{tg} \delta \leq 0.003$ CR $>1.0 \mu\text{F}$ at 1KHZ 1.6 UR (d.c) 60S耐电压后无击穿或飞弧 No permanent breakdown or flashover $\Delta R/R \leq 50\%$ Test voltage: No UR (d.c.) time:1Cycle/s Cycle times:10000 Dv/Dt:100 V/ μs . resistor: (220*10 ⁻⁶ / CR) Ω IEC60384-2 C4.13 IEC60384-1 C4.27
10	振动 Vibration	外观 Appearance 无可见损伤,标志清晰 No visible damage , The marking shall be legible 。	上下左右前后三个方向各2H, 频率10-55Hz 振幅0.75mm或98m/S ² 3 directions at 2 hours each 10-55Hz at 0.75mm or 98m/s ² IEC60384-2 C4.7 IEC60384-1 C4.17 IEC 60068-2-6, test Fc,
11	碰撞或冲击 Bump	外观 Appearance 无可见损伤,标志清晰 No visible damage , The marking shall be legible 。	次数 number of bumps: 1 000 or 4 000 加速度Acceleration: 400 m/s ² Pulse duration: 6 ms IEC60384-2 C4.8/4.9 IEC60384-1 C4.18 IEC 60068-2-29, test Eb,
12	阻燃试验 Passive flammability test	火焰等级: B Category of flammability 火焰时间: 10S Flame exposure time 最大燃烧时间: 10s Maximum burning time	UL94-V0 IEC60384-1 C4.38 IEC60695-11-5.

X-ON Electronics

Largest Supplier of Electrical and Electronic Components

Click to view similar products for [Film Capacitors](#) category:

Click to view products by [Dersonic](#) manufacturer:

Other Similar products are found below :

[M83421/01-3089R](#) [703-6G](#) [F450KG153J250ALH0J](#) [750-1018](#) [FKP1-1000160010P15](#) [FKP1-1500160010P15](#) [FKP1U024707E00KYSD](#)
[82EC1100DQ50K](#) [MMWAF150KME](#) [PCY2130F30153](#) [PME261JB5220KR19T0](#) [A521HH333M035C](#) [QXJ2E474KTPT](#) [QXL2B333KTPT](#)
[QXM2G104K](#) [B32234-.033@250V-K](#) [B32520C6332K000](#) [B32522C6104K000](#) [B32523Q3155J](#) [B32676E6755K](#) [B81133-C1104-M3](#)
[MTC355L1](#) [217-0716-001](#) [PA225L30](#) [221A10-120](#) [CB182K0184J--](#) [KP1830-247/061-G](#) [SCD105K122A3-22](#) [SCD205K122A3-24](#)
[F601BL225K063CL60A](#) [PCX2339F65224](#) [PCX2339F65334](#) [2222 368 55105](#) [2222 370 21683](#) [QXL2E473KTPT](#) [445450-1](#) [B32524Q6155J](#)
[46KI3100JBM1K](#) [MKP 1839-215-633](#) [MKP 1840-447-165](#) [MKP383510063JKP2T0](#) [MKT182022263473](#) [WMC08P22](#) [YE333](#) [ECQ-](#)
[W4223KZ](#) [EEC2G805HQA415](#) [PA103L30](#) [82DC3100DQ50J](#) [82EC2150DQ50K](#) [WMF1D68](#)