

承认书编号 Admitted NO		发布日期 Release Date		版本 Version	A/0
承认书名称 Admitted Name	CBB 薄膜电容器			页码 Pagination	第 1 页, 共 19 页

规格承认书

SPECIFICATION FOR APPROVAL

客户名称 (CUSTOMERS):	
客户料号 (CUSTOMERSM.NO) :	
客户型号: (PART NUMBER) :	
产品料号 (OUR PN) :	
品名规格 (SEPCIFICATION) :	
日期 (DATE) :	2018-07-06

制造商确认 MANUFACTURE			客户确认 CUSTOMER		
拟制 DESIGNER	审核 CHECKER	批准 APPROVED	拟制 DESIGNER	审核 CHECKER	批准 APPROVED
孙伟荣	孙伟荣	马俊			
承认章			承认章		

客户确认签核盖章后, 请回传一份承认书给我公司。

PLEASE RETURN TO US A COPY OF "SPECIFICATION FOR APPROVAL" WITH YOU APPROVED SIGNATURE.

地址: 东莞市长安镇锦厦河南工业区锦平路 5 号

No. 5Jingping Road, Jinxia Henan Industrial Zone, Changan Town Dongguan City China



目录

CONTENTS

1. 规格尺寸	4
2. 品号解析	5
3. 产品介绍	6
4. 产品结构和关键材料	7
5. 典型应用	7
6. 特点.....	8
7. 电气特性	9
8. 印字.....	10
9. 电流对频率特性	11
10. 温度特性	12
11. 使用指导	13
11.1 焊锡	13
11.2 波峰焊.....	13
10.3 烙铁焊接	13
12. 环保要求	14
13. 参考标准	14
14. 包装.....	14
15. 存储条件.....	15
16. 可靠性实验.....	19

2. 品号解析

CF	C	2A	103	J	C	1	H	F5	09	3	000
1	2	3	4	5	6	7	8	9	10	11	12

(1) 表示产品型号，CF代表薄膜电容

(2) 标表示薄膜电容分类

C	D	F	H	J
CBB21	CBB22	CBB81	CBB65	CBB28

(3) 表示电压

2A	2E	2F	2G	2W	2H	2J	3A
100V	250V	300V	400V	450V	500V	630V	1KV

(4) 表示额定容量

标称容量采用三位数字表示法, 前二位数位为有效数值, 第三位表示 0 的个数

代码	100	101	102	222	471	472	103
容量	10pF	100pF	1000pF	2200pF	470pF	4700pF	10nF

(5) 表示容量误差

代码	F	G	H	J	K	M
容差	±1%	±2%	±3%	±5%	±10%	±20%

(6) 表示脚距 (mm)

代码	C	D	E	G	H	I	K	L	P	Q
脚距	5.08	7.5	10.0	15.0	17.5	20	25	27.5	30	37.5

(7) 表示脚型

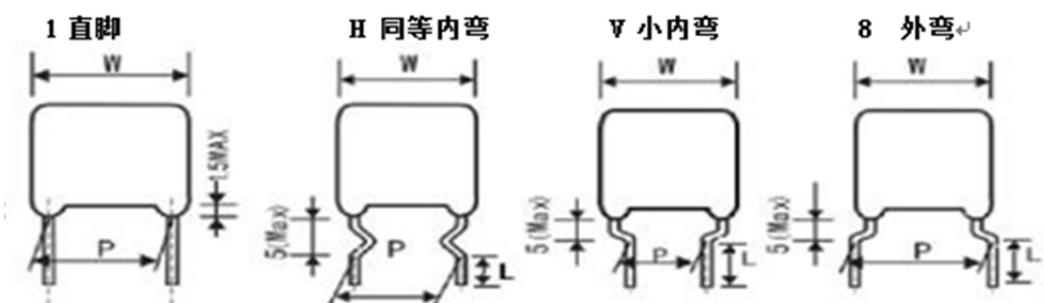

(8) 包装方式与脚长 (单位 mm)

代码	N	Z	1	2	3	4	5	6	G	I	J	P	T	W	Y
宽度	2.3	2.5	2.8	3.0	3.2	3.5	3.8	4.0	20	24	26	盒装 编带	卷装 编带	弯脚 编带	直脚 编带

(9) 电容本体宽度 (单位 mm)

代码	07	08	09	J5	10	12	M5	17	S5	22	23	24	25	26	28
宽度	7	8	9	9.5	10	12	12.5	17	17.5	22	23	24	25	26	28

(10) 电容本体高度 (单位 mm)

代码	07	08	09	0B	0P	0C	0O	0D	0U	0E	0F	0T	0G	0I	0K
宽度	8	8.5	9	10	10.5	11	11.5	12	12.5	13	14	14.5	15	17	19

(11) 电容本体厚度 (单位 mm)

代码	1	2	3	4	5	6	7	8	9	A	B	C	D	E	F
宽度	3	3.5	4	4.5	5	5.5	6	6.5	7	7.5	8	8.5	9	9.5	10

(12) 内部管控码

3. 产品介绍

Products Introduction

MPP 电容是由金属化聚丙烯薄膜，采用无感结构卷绕而成，引线采用镀锡铜包钢线/镀锡铜线，外部使用阻燃环氧粉体封装而成。具有良好的自愈功能和优良的阻燃性，符合 UL94-V0 标准。

MPP are winded with metallized polypropylene film dielectric, Non-inductive construction, tinned copper wire leads or tinned copper leads, and flame retardant epoxy resin coating.

They have excellent features of self-healing and good flame retardant according to UL 94-V0

4. 产品结构和关键材料

Construction and main materials of products

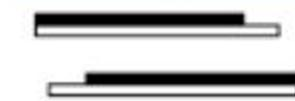
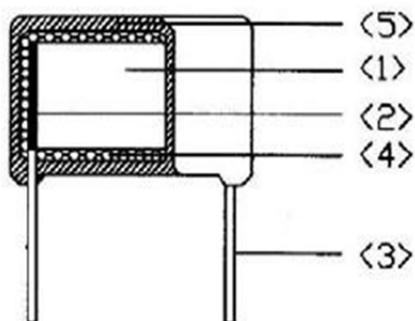

Metallized film construction

NO	关键材料 Main Materials	材料规格 Specification	备注 Remark
1	金属化聚丙烯薄膜 Metallized polypropylene Film	MPPZAH or MPPA(4~12um)	...
2	锌锡层 Zn,Sn line	锌或锌锡合金 Zn or Zn and Sn alloy	...
3	导线 Terminal	镀锡铜包钢线(Φ0.6 or 0.8/1.0mm CP or CU	镀锡层厚度 7um 以
4	内封装材料 Inside Coating Material	环氧树脂 Epoxy resin	UL94-V0
5	外封装材料 Outside Coating Material	环氧粉末 Epoxy power	UL94-V0

注：以上材料均符合环保要求

Note:All of the Materials are in compliance with the requirements of ROHS AND REACH.

5. 典型应用

Type application

本产品用于隔直流，耦合，去耦，滤波，旁路，计时，温控，广泛应用于通信设备，数据处理设备，工业设备，自动控制系统以及其他大型电子设备的理想元件。

The Products are suitable for blocking,coupling,decoupling,filtering,by pass,timing,temperature control and idea for use in telecommunication equipments, data processing equipments, industrial instruments,automatic control systems and other general electronic equipments,Etc.

6. 特点

Features

5.1 无感结构 Non-induction construction 5.2

优良的耐湿性 High moisture-resistance 5.3

自愈性 Self-healing property

5.4 阻燃性(符合 UL 94V-0) Flame retardant type (compliance with UL 94V-0) 5.5

非常小的损耗 Very small loss

5.6 优秀的容量, 损耗的频率和温度特性 Excellent capacitance and DF for frequency and temperature characteristics

5.7 高绝缘阻值 High insulation resistance

7. 电气特性

Electrical specifications

如无其他说明, 电气特性请参考 IEC 60384-16:2005

Unless otherwise specified, electric characteristics shall refer to IEC 60384-16:2005

项目 Item	特性要求 Characteristic requirement				测试方法及条件 Test method&Condition			
工作温度 Operating Temperature	-40℃~+105℃ 在温度 85℃(AC form 75℃)以上时, 每上升 1 度, 额定电压下降 1.35% +85℃~+105℃(AC FROM 75℃): derating factor 1.35% per℃ for R.V(DC))							
容量范围 Capacitance Range	0.001uF~10.0uF				1KHz ,1.0Vrms ,20℃			
容量偏差 Capacitance Tolerance	±1%(F),±2%(G),±2.5%(H),±3%(I),±5%(J),±10% (K)				1KHz ,1.0Vrms ,20℃			
额定电压 Rated Voltage	100/160/250/400/450/630/1000V							
损耗角正切 Dissipation Factor		C≤0.47μF	0.47μF<C≤1.0μF	C>1.0μF	1KHz ,1.0Vrms ,20℃			
	1KHZ	0.10%	0.10%	0.10%				
	10KHZ	0.20%	0.40%	0.80%				
	100KHZ	0.60%						
绝缘阻值 Insulation Resistance		C≤0.33μF	C≥0.33μF		100VDC,60S,20℃			
		IR≥100000MΩ	IR≥30000s					
		or≥30000MΩ·Uf						
端子间电压 Withstand voltage Between Terminals	应无永久性击穿或飞弧 No permanent breakdown or flashover				1.6Ur(d.c) 60s;2Ur(d.c)5s C>1uf,Cut off Current 10mA , C≤1uf,Cut off Current 5mA , ARC=OFF, Voltage raising time 5~10s,for voltage rise AC:150V/S;DC:250V/ S			
最大脉冲爬升速率 Maximum Pulse rising gradient(dv/dt)	Ur(V)	dv/dt(V/us)						
		P=7.5	P=10.0	P=15.0	P=20.0/ 22.5	P=27.5/ 25.0	P=31.5	P=41.5
	100V	180	150	110	60	60	45	30
	250V	660	300	220	110	75	60	40
	400V	900	515	380	180	120	95	65
	450V	900	515	380	180	120	95	65
630V	1500	700	510	220	150	120	85	

容许单个尖峰值(脉冲)电流值 Permissible currnt valuse; $I(Ao-P)=C(Uf)*dv/dt(v/us)$; 若连续的尖峰值电流值应用于重复或频繁出现的脉冲情形, 要按其峰值的 0.55 倍率设定, 较为安全。

说明 NOTE:

1.若实际工作电压 (U) 比额定电压(Ur)低, 电容器可工作在更高的 dv/dt 场合, dv/dt 最大值应为上表值乘以(Ur/U).

1.If the working voltage (U) is lower than the rated voltage(Ur),the capacitor can be worked at a higher dv/dt. In this case,the maximum allowed dv/dt is obtain by multiplying the above value with Ur/U.

注: 额定电压定义: 在工作温度范围内, 电容持续运行的可承受电压。但是, 工作温度在 85℃~105℃之间时(AC form 75℃), 每上升 1℃, 额定工作电压应下降 1.35%。

Note:Rated voltage is defined the voltage which shall capable of applying to capacitors continuously in the operating temperature range.However, rated voltage shall be derated 1.35% per℃ when capacitors operation temperature is between 85℃to 105℃(AC from 75℃).

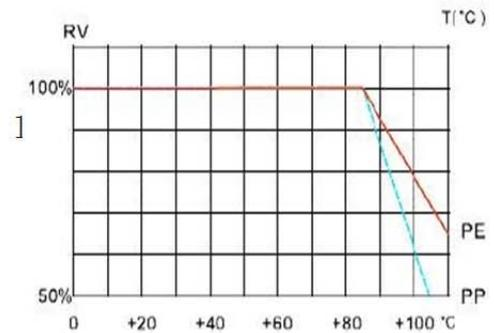

注: 电容器工作电压 (Operating voltage of the capacitor)

确认使用在电容器两个端子上的工作电压, 无论直流电压, 直流+交流电压, 交流电压, 脉冲电压, 均应在额定电压范围内。

Before using, make sure the voltage applied to the both ends of the capacitor is within the limit of the rated voltage,however DC voltage,DC and AC voltage,AC voltage,Pulse voltage etc.

Voltage	(1) DC voltage	(2) DC+AC voltage	(3) AC voltage
Positional Measurement (Rated voltage)			
Voltage	(4) Pulse voltage (A)	(5) Pulse voltage (B)	
Positional Measurement (Rated voltage)			

注: 电容器使用工作温度范围 **Capacitor working temperature range** 确认电容器使用的温度 (环境温度+电容器自身表面温升+环境辐射温度), 不要超过其额定温度范围内。 Before

using,please make sure the capacitor working temperature (the ambient temperature+capacitor's temperature+temperature rise caused by environmental radiation temperature) is used should not exceed its rated temperature. 在交流或高频脉冲线路中电容器由于电流通过而发热, 如果温升过高将会烧毁电容器。

The capacitors used in AC or high frequency pulse circuit emit heat due to the current flowing through ,if the temperature is too high will burn up capacitors.

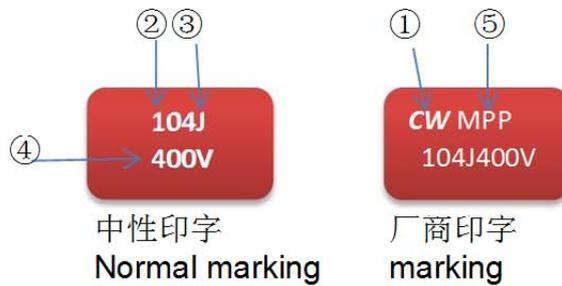

8. 印字 Marking

- (1) 厂商商标 logo:
- (2) 静电容量 Capacitance: 104
- (3) 允许误差 Capacitance Tolerance: $\pm 5\%$ (J)
- (4) 额定电压 Rated Voltage: 100/160/250/400/450/630/1000V
- (5) 产品类别 Product Class: CBB/MPP

9. 电流对频率特性

Arms Vs Frequency

A permissible current is regulated by both a root-mean-square value current and a peak current.

A root-mean-square value current is to be a permissible current value to frequency attached.

The values of continuous peak current in the allowable peak current shall be those of continuous current,

And the values of single peak current shall be those of discontinuous current such as rush current in

Switching on or off. The highest number of times of single peak current shall be limited to 10,000times.

(In case of exceeding 10,000times, please contact us.)

允许电流通常由均方根电流和尖峰电流表示。

均方根电流(等效电流)如下附图所示

允许尖峰电流中的连续尖峰电流值应为持续电流，单个尖峰电流应为不连续电流，如开关动作中的脉冲电流。最高次数的单峰电流次数应限制在 10000 次内(若有超过 10000 次，请告知我们)。Characteristics of permissible current (Arms)Vs Frequency - (sinusoidal wave, $\Delta T \leq 12^\circ\text{C}$) 允许电流 (Arms) 对频率特性曲线图 (正弦波, $\Delta T \leq 12^\circ\text{C}$)

100V/160V/250V

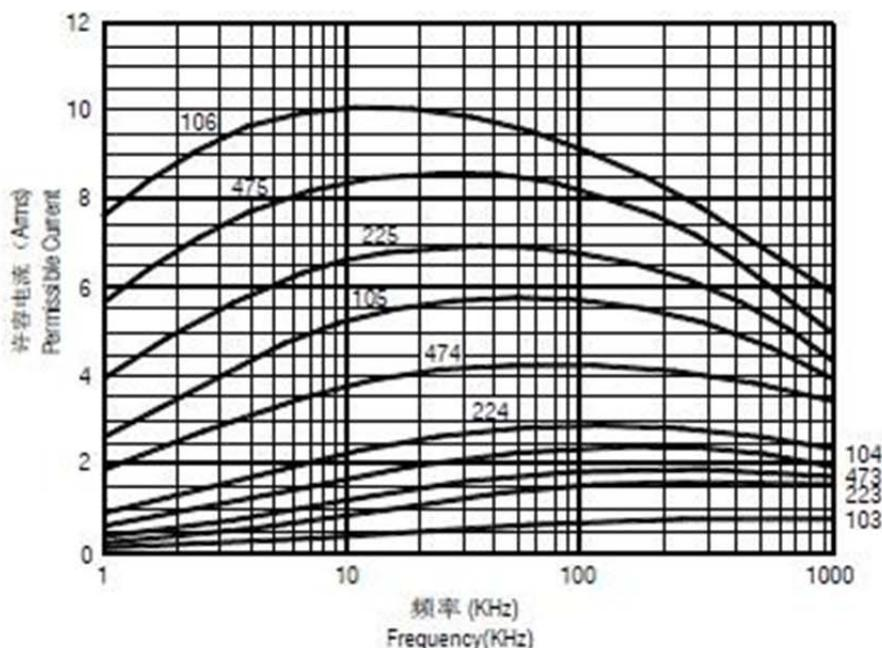

Characteristics of permissible current (Arms) Vs Frequency

电流 Vs 频率特性图

允许电流 (Arms) 对频率特性曲线图 (正弦波, $\Delta T \leq 12^\circ\text{C}$)

400V/450V

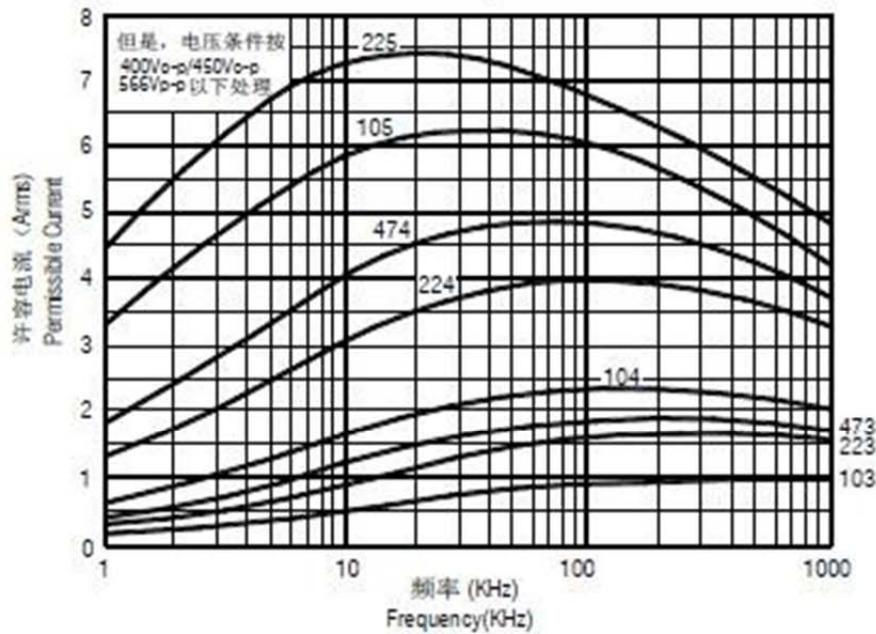

允许电流 (Arms) 对频率特性曲线图 (正弦波, $\Delta T \leq 12^\circ\text{C}$)

630 V

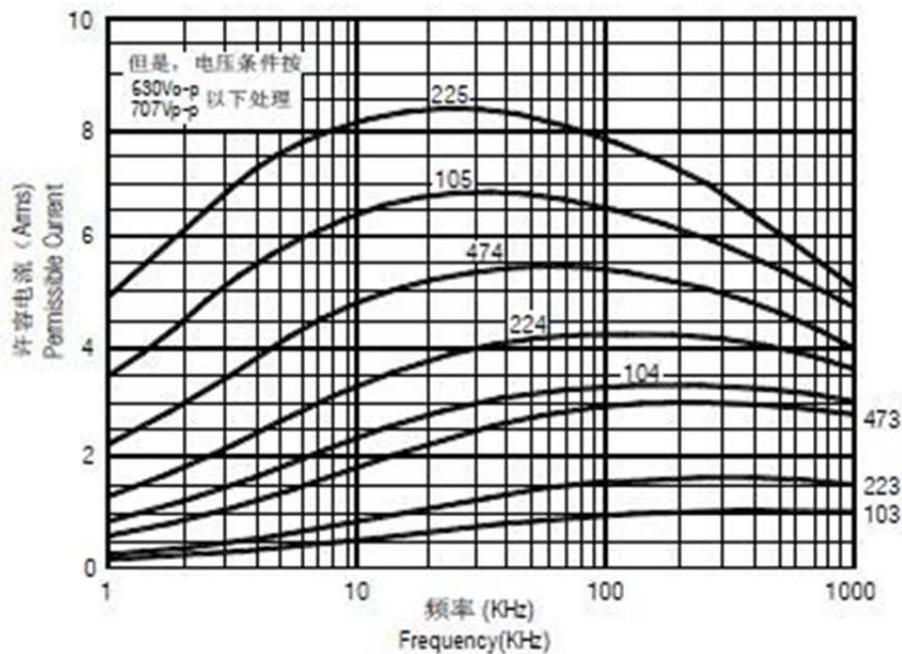

10.温度特性

TEMPERATURE CHARACTERISTICS

CHARACTERISTICS

TYPICAL GRAPHS

TEMPERATURE CHARACTERISTICS

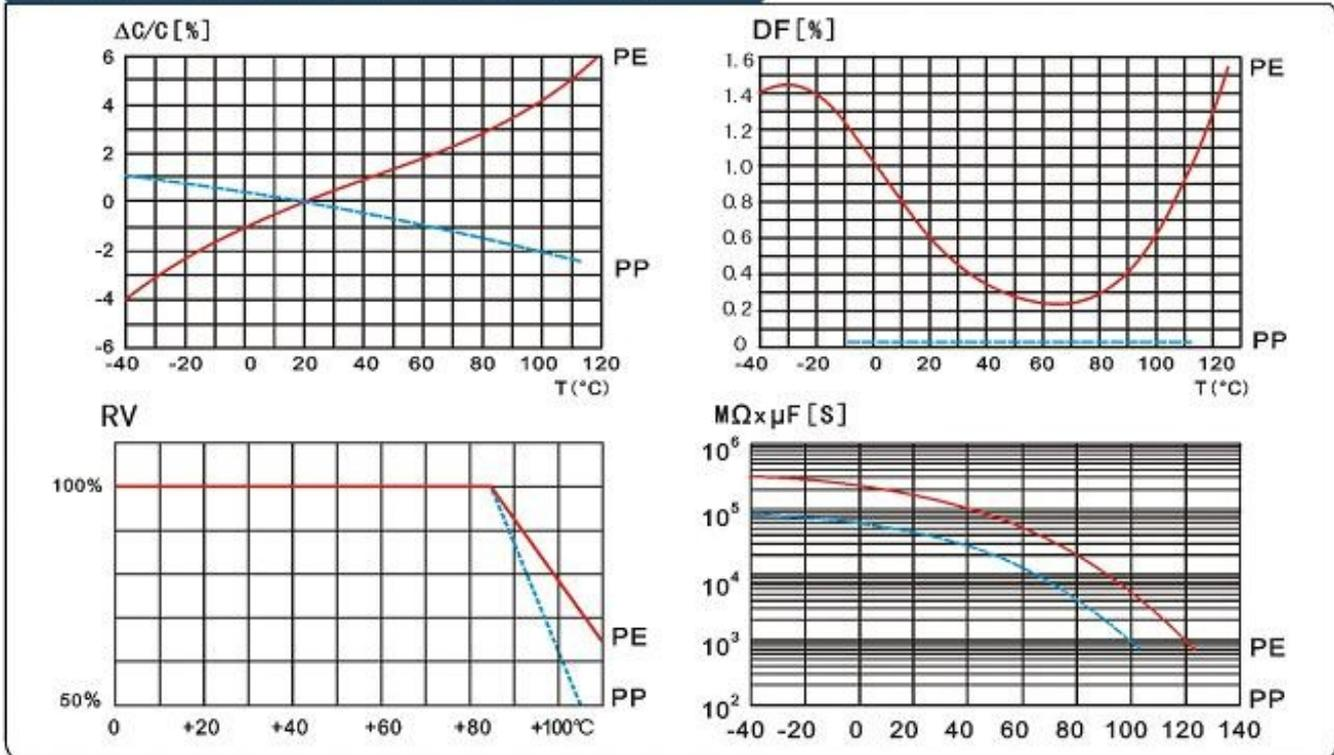

SOLDERING TEMPERATURE VS. TIME

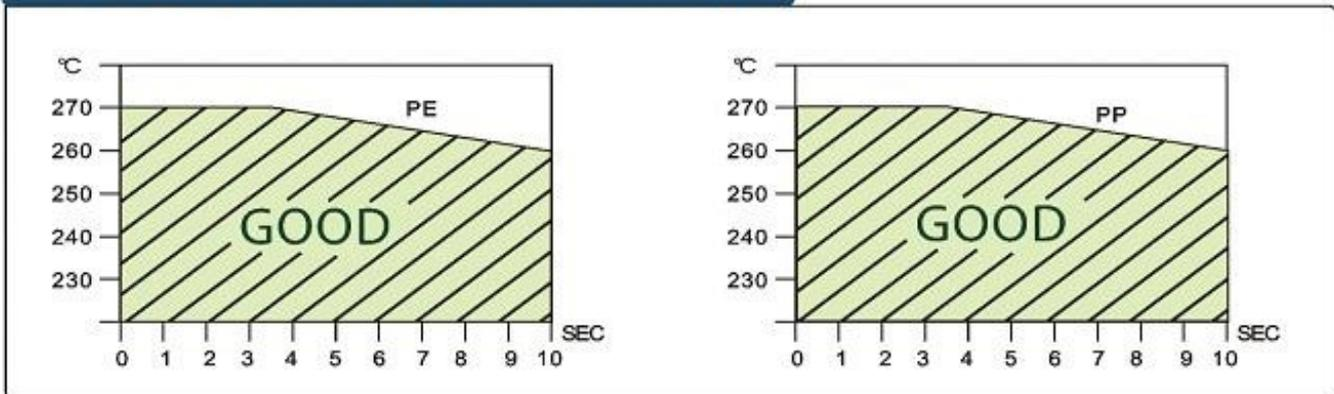

FREQUENCY CHARACTERISTICS

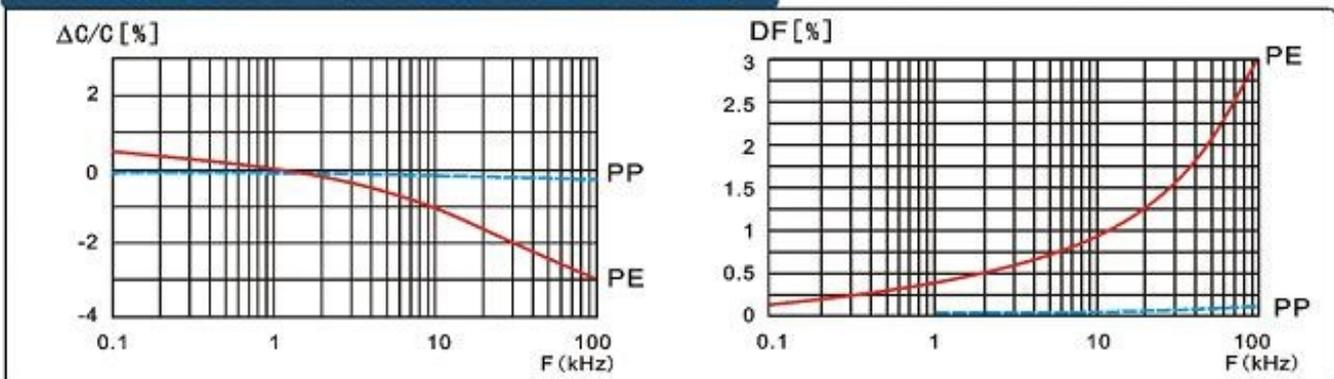

11.使用指导

Guide in useage

11.1 焊锡

Soldering 当焊接电容器时，焊锡热会通过引线端子和封装层传递到电容素子，因此必须注意高温 和长时间焊接引起的电容电气特性衰减或包封层损坏。请确认焊锡在以下温度范围内。

When soldering a capacitor,heat in soldering is conducted to the element of the capacitor from wire lead and an enclosure,and hence it should be noted that soldering under high temperature and long period may cause deterioration of characteristic or coating breakdown of capacitors.

Be sure to solder within the following temperature condition range.

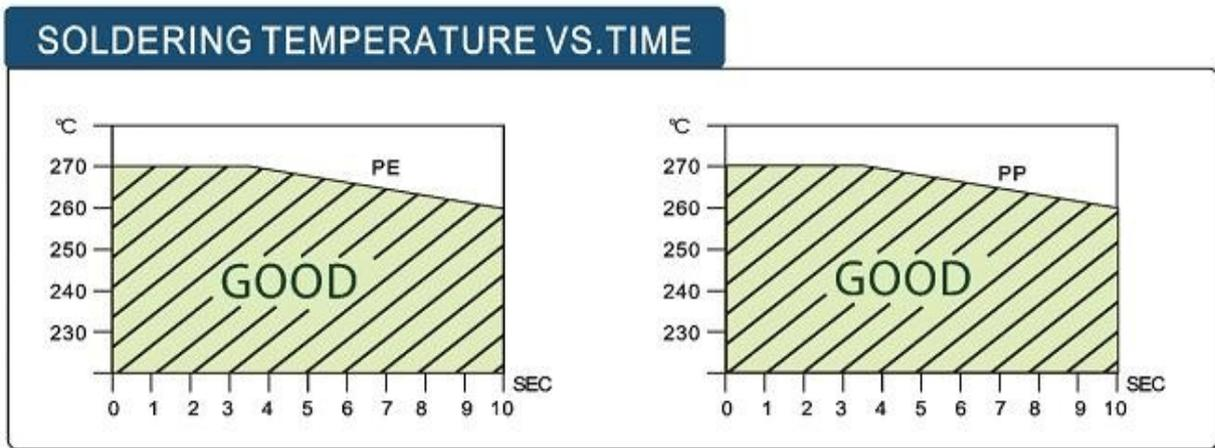

11.2 流焊/波峰焊

FLOW / WAVE SOLDERING

PRODUCTS: FILM CAPACITORS (Application of Through-Hole)

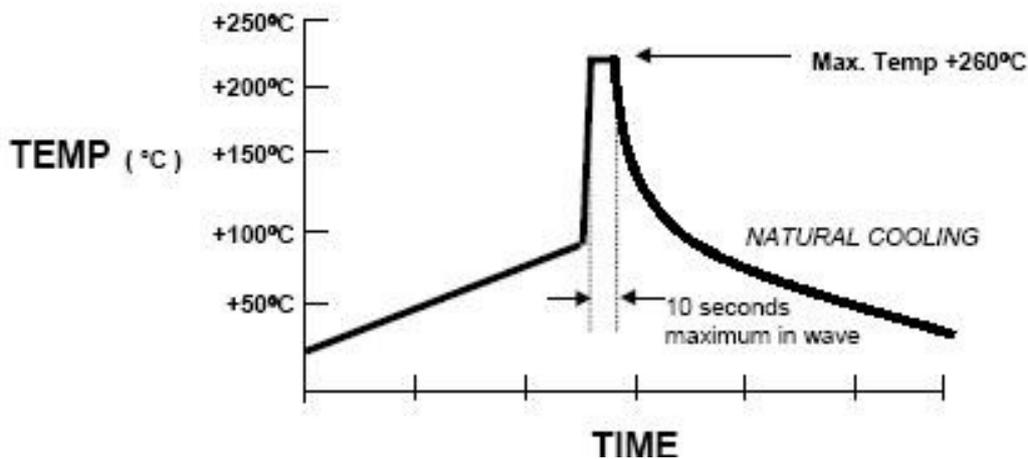

11.3 烙铁焊接

soldering iron

当使用烙铁焊接时，烙铁尖端温度不得超过 350°C，焊接时间不超过 5 秒

When using soldering iron,iron tip temperature less than 350°C,Soldering time(sec.)within 5 seconds.

11.4 组装 assembled 当组装到电路板上的时候，尽量避免贴近发热源。

when assembling to circuit board, Try to avoid getting close to the heat source



12.环保要求

Environment requirement

11.1 符合 ROHS 要求 Compliance with the requirement of ROHS.

11.2 符合 REACH 要求 Compliance with the requirement of REACH.

11.3 符合无卤（如要求） Without Halogen(as required).

13.参考标准

Reference standards

GB-T2693-2001 (IDT IEC 60384-1-2008) 电子设备用固定电容器 第 1 部分 总规范

GB-T10190-1988 电子设备用固定电容器 第 16 部分 分规范 金属化聚丙烯膜介质直流固定电容器

IEC-60384-16-2005 电子设备用固定电容器 第 16 部分 分规范 金属化聚丙烯膜介质直流固定电容器

GB-T 2828.1-2003 计数抽样检验程序 第 1 部分 按接收质量限(AQL)检索逐批检验抽样计划

GB-T2693-2001 (IDT IEC 60384-1-2008) Fixed capacitors for use in electronic equipment –Part 1: Generic specification

GB-T10190-1988 Fixed capacitors for use in electronic equipment –Part 16:Sectional specification: Fixed metallized polypropylene film D.C. capacitor

IEC-60384-16-2005 Fixed capacitors for use in electronic equipment –Part 16:Sectional specification: Fixed metallized polypropylene film D.C. capacitor

GB-T 2828.1-2003 Sampling procedures for inspection by attributes—Part 1: Sampling schemes indexed by acceptance quality limit (AQL)for lot-by-lot inspection (ISO 2859-1:1999, IDT)

14.包装

Packing



塑料袋最小包装，数量为 100、200、500、1000PCS

Plastic bag is the minimum packing.the quantity are 100、200、500、1000PCS. 袋内放置产品合格环保标识标签，包括料号，规格，数量，LOT 批号，生产日期等 The label of the ROHS include the product name、specification、quantity、lot No、manufacture date etc.



N 袋小包装装一内箱

One inner box have N PCS bags 内箱尺寸为（长×宽×高）=23×30×30cm Inner box size (L×W×H) =23×30×30cm 有环保标识

Marking for ROHS AND SVHC



两内箱装一外箱

One outer box have two Inner boxes 外箱尺寸为（长×宽×高）=48×32.2×33cm Outer box size (L×W×H) ==48×32.2×33cm 有环保标识

Marking for ROHS AND SVHC

15.存储条件

Storage conditions

14.1 请注意，长时间产品暴露在空气中会导致引线氧化，焊接性能衰减。

It should be noted that the solderability of the terminals may be deteriorated when stored barely in an atmosphere for a long periods

14.2 不能放置在高温高湿环境中，请遵循以下存储条件（原包装下保存）

It shouldn't be located in particularly high temperature and high humidity, it must submit to the following conditions(keeping in the original package)

温度 Temperature: 35°C MAX

相对湿度 Relative humidity: 60% MAX

14.3 存储时间：最长 12 个月（以包装袋上标注的生产日期为准）

Storage period: Losse: 12 monthes max

(from the manufacturing date marked on the label in package bag)

16.可靠性实验

Reliability test

16.1 测试条件：除非另有规定，所有试验和测量均应在 GB2421—81 第 4.3 条（IEC68 1 第 5.3 条）中规定的试验用标准大气条件下进行,条件如下：

Test condition: Unless otherwise specified ,all tests and measurements shall be made under standard atmospheric conditions for testing as given in GB2421-81 NO.4.3(IEC68-1 NO.5.3),AS follows

温 度 Temperature: 15°C — 35°C

相对湿度 Relative humidity: 25%— 75%

气 压 Air pressure: 86—106Kpa (860—1060mbra)

16.2 如对测试结果有任何疑问，则按一下限制测试：

If there may be any doubt on the results, measurements shall be made within the following limits.

环境温度 Ambient temperature: 20±2°C

环境湿度 Relative humidity: 50~70%

16.3 电性参数参考 IEC 60384-1:2008 ,IEC 60384-16:2005, IEC 60068-2-2;IEC 60068-2-21

Electric characteristics shall refer to IEC 60384-1:2008 ,IEC 60384-16:2005, IEC 60068-2-2;IEC 60068-2-21

16.4 电性参数

Electric characteristics

项目 Item	特性要求 Characteristic requirement				测试方法及条件 Test method&Condition		
容量范围 Capacitance Range	0.001uF~10.0uF				IEC60384-16 4.2.2 IEC60384-1 4.7		
容量偏差 Capacitance Tolerance	±1%(F), ±2%(G), ±2.5%(H), ±3%(I), ±5%(J), ±10%(K)				1KHz, 1.0Vrms, 20°C		
额定电压 Rated Voltage	100/160/250/400/450/630/1000V						
损耗角正切 Dissipation Factor		$C \leq 0.47 \mu F$	$0.47 \mu F < C \leq 1.0 \mu F$	$C > 1.0 \mu F$	1KHz, 1.0Vrms, 20°C		
	1KHZ	0.10%	0.10%	0.10%			
	10KHZ	0.20%	0.40%	0.80%			
	100KHZ	0.60%					
绝缘阻值 Insulation Resistance		$C \leq 0.33 \mu F$	$C \geq 0.33 \mu F$		100VDC, 60S, 20°C		
		$IR \geq 100000M \Omega$	$IR \geq 30000s$				
			$or \geq 30000M \Omega \cdot Uf$				
端子间电压 Withstand voltage Between Terminals	应无永久性击穿或飞弧 No permanent breakdown or flashover				1.6Ur(d.c) 60s; 2Ur(d.c) 5s C>1uf, Cut off Current 10mA, C≤1uf, Cut off Current 5mA, ARC=OFF, Voltage raising time 5~10s, for voltage rise AC: 150V/S; DC: 250V/S		

16.5 寿命实验

Life Test

NO	项目 Item	特性要求 Characteristic requirement	测试方法及条件 Test method&Condition		
1	端子强度 Terminal Strength	拉伸强度 Pull Strength 无可见机械损伤 There shall be no visible mechanical damage	线径 mm	荷重	时间
			wire diameter	Load	Time
			≤0.5	5N	10S
			0.5<d≤0.8	10N	10S
			0.8<d≤1.25	20N	10S
			IEC60384-16 C4.3 IEC60384-1 C4.13 IEC60068 2-21 Test Ua1		
	端子强度 Terminal Strength	弯曲强度 Bending Strength 无可见机械损伤 There shall be no visible mechanical damage	线径 mm	荷重	次数
			wire diameter	Load	Time s
			≤0.5	5N	90°C×4
			0.5<d≤0.8	5N	90°C×4
			0.8<d≤1.25	5N	90°C×4
			IEC60384-16 C4.3 IEC60384-1 C4.13 IEC60068 2-21 Test Ua1		

NO.	项目 Item	特性要求 Characteristic requirement	测试方法及条件 Test method&Condition
2	可焊性 Solderability	端子引线周围至少 95%的面积均匀附锡, 且本体无破裂等损坏现象 锡料成分 Sn 97.5%+ Ag 2%+Cu 0.5% At least 95% of the Circumference of the Lead wire.Around lead surface dipped into with new soler, the body be no visible damage.	焊锡温度: 235±5℃ Solder temp 浸渍时间: 2.0±0.5S Immersion time IEC60384-16 C4.5 IEC60384-1 C4.15 IEC60068-2-20 Test Ta
3	耐焊接热 Resistance to Soldering heat	外观 Appearance 无可见损伤,标志清晰 No visible damage, The marking shall be legible. 容量变化 Capacitance Variation $\Delta C/C \leq 5\%$ 损耗 Dissipation Factor $\Delta \text{tg}\delta < 0.0080$ CR $\leq 1.0\mu\text{F}$ $\Delta \text{tg}\delta < 0.0050$ CR $> 1.0\mu\text{F}$ at 1KHZ 耐电压 Withstand Voltage 1.6 UR (d.c) 60S 耐电压后无击穿或飞弧 No permanent breakdown or flashover 绝缘电阻 Insulation Resistanc $\Delta R/R \leq 50\%$	焊锡温度: 260±5℃ Solder temp 浸渍时间: 10±1S Immersion time 恢复时间 1-2 小时 Then recovery at ordinary condition 1~2hours IEC60384-16 C4.4 IEC60384-1 C4.14 IEC60068-2-20 Test Tb
4	耐久性 Endurance	外观 Appearance 无可见损伤,标志清晰 No visible damage, The marking shall be legible. 容量变化 Capacitance Variation $\Delta C/C \leq 5\%$ 损耗 Dissipation Factor $\Delta \text{tg}\delta < 0.0080$ CR $\leq 1.0\mu\text{F}$ $\Delta \text{tg}\delta < 0.0050$ CR $> 1.0\mu\text{F}$ at 1KHZ 耐电压 Withstand Voltage 1.6 UR (d.c) 60S 耐电压后无击穿或飞弧 No permanent breakdown or flashover 绝缘电阻 Insulation Resistanc $\Delta R/R \leq 50\%$	温度 Temp: 105±3℃ 持续时间: Duration 1000+48h 施加电压 voltage: 1.25 Ur(d.c.)50hz 恢复时间至少 16 小时 Then recovery at ordinary condition at least 16 hours IEC60384-16 C4.12 IEC60384-1 C4.23 IEC60068-2-2
5	稳态湿热 Damp heat, steady	外观 Appearance 无可见损伤,标志清晰 No visible damage, The marking shall be legible. 容量变化 Capacitance Variation $\Delta C/C \leq 5\%$ 损耗 Dissipation Factor $\Delta \text{tg}\delta < 0.0080$ CR $\leq 1.0\mu\text{F}$ $\Delta \text{tg}\delta < 0.0050$ CR $> 1.0\mu\text{F}$ at 1KHZ 耐电压 Withstand Voltage 1.6 UR (d.c) 60S 耐电压后无击穿或飞弧 No permanent breakdown or flashover 绝缘电阻 Insulation Resistanc $\Delta R/R \leq 50\%$	温度 Temp: 40±2℃ 湿度: 90-95%RH Humidity 持续时间: 56 day Duration 电容不施加电压 恢复时间 1-2 小时 Then recovery at ordinary condition 1-2 hours IEC60384-16 C4.11 IEC60384-1 C4.22 IEC60068-2-78 Test Cab

NO	项目 Item	特性要求 Characteristic requirement	测试方法及条件 Test method&Condition
6	干热 Dry heat	外观 Appearance	无可见损伤,标志清晰 No visible damage, The marking shall be legible.
		容量变化 Capacitance Variation	$\Delta C/C \leq 5\%$
		损耗 Dissipation Factor	$\Delta \text{tg}\delta < 0.0080$ $CR \leq 1.0\mu\text{F}$ $\Delta \text{tg}\delta < 0.0050$ $CR > 1.0\mu\text{F}$ at 1KHZ
		耐电压 Withstand Voltage	1.6 UR (d.c) 60S 耐电压后无击穿或飞弧 No permanent breakdown or flashover
		绝缘电阻 Insulation Resistanc	$\Delta R/R \leq 50\%$
			温度 Temp: 105±2℃ 持续时间: 16h Duration 恢复时间不低于 4 小时 Then recovery at ordinary condition at least 4 hours IEC60384-16 C4.10.2 IEC60384-1 C4.21.2 IEC60068-2-2, test Bb
7	寒冷 Cold	外观 Appearance	无可见损伤,标志清晰 No visible damage, The marking shall be legible.
		容量变化 Capacitance Variation	$\Delta C/C \leq 5\%$
		损耗 Dissipation Factor	$\Delta \text{tg}\delta < 0.0080$ $CR \leq 1.0\mu\text{F}$ $\Delta \text{tg}\delta < 0.0050$ $CR > 1.0\mu\text{F}$ at 1KHZ
		耐电压 Withstand Voltage	1.6 UR (d.c) 60S 耐电压后无击穿或飞弧 No permanent breakdown or flashover
		绝缘电阻 Insulation Resistanc	$\Delta R/R \leq 50\%$
			温度 Temp: -40±2℃ 持续时间: 4h Duration 恢复时间不低于 4 小时 Then recovery at ordinary condition at least 4 hours IEC60384-16 C4.10.4 IEC60384-1 C4.21.4 IEC60068-2-1, test Ab
8	浪涌 Surge	外观 Appearance	无可见损伤,标志清晰 No visible damage, The marking shall be legible.
		容量变化 Capacitance Variation	$\Delta C/C \leq 5\%$
		损耗 Dissipation Factor	$\Delta \text{tg}\delta < 0.0080$ $CR \leq 1.0\mu\text{F}$ $\Delta \text{tg}\delta < 0.0050$ $CR > 1.0\mu\text{F}$ at 1KHZ
		耐电压 Withstand Voltage	1.6 UR (d.c) 60S 耐电压后无击穿或飞弧 No permanent breakdown or flashover
		绝缘电阻 Insulation Resistanc	$\Delta R/R \leq 50\%$
			When $CR \leq 1.0 \mu\text{F}$ UP = 1.6UR When $CR > 1.0 \mu\text{F}$ UP = UR time:10s Cycle times:24 次 前三次脉冲没有发生 自愈性击穿, 则可 停止, 为合格 IEC60384-1 C4.26 IEC60060-1

NO	项目 Item	特性要求 Characteristic requirement	测试方法及条件 Test method&Condition
9	充放电 Charge and discharge	外观 Appearance 无可见损伤,标志清晰 No visible damage, The marking shall be legible. 容量变化 Capacitance Variation $\Delta C/C \leq 5\%$ 损耗 Dissipation Factor $\Delta \text{tg}\delta < 0.0080$ $CR \leq 1.0\mu\text{F}$ $\Delta \text{tg}\delta < 0.0050$ $CR > 1.0\mu\text{F}$ at 1KHZ 耐电压 Withstand Voltage 1.6 UR (d.c) 60S 耐电压后无击穿或飞弧 No permanent breakdown or flashover 绝缘电阻 Insulation Resistanc $\Delta R/R \leq 50\%$	Test voltage: UR (d.c.) time:1Cycle/s Cycle times:10000 Dv/Dt:100 V/ μs . resistor: $(220 \times 10^{-6} / CR) \Omega$ IEC60384-16 C4.13 IEC60384-1 C4.27
10	振动 Vibration	外观 Appearance 无可见损伤,标志清晰 No visible damage, The marking shall be legible.	上下左右前后三个方向 各 2H, 频率 10-55Hz 振幅 0.75mm 或 8m/S ² 3 directions at 2 hours each 10-55Hz at 0.75mm or 98m/s ² IEC60384-16 C4.7 IEC60384-1 C4.17 IEC 60068-2-6, test Fc,
11	碰撞或冲击 Bump	外观 Appearance 无可见损伤,标志清晰 No visible damage, The marking shall be legible.	次数 number of bumps: 1 000 or 4 000 加速度 Acceleration: 400 m/s ² Pulse duration: 6 ms IEC60384-16 C4.8 IEC60384-1 C4.18 IEC 60068-2-29, test Eb,
12	阻燃试验 Passive flammability test	火焰等级: B Category of flammability 火焰时间: 10S Flame exposure time 最大燃烧时间: 10s Maximum burning time	UL94-V0 IEC60384-1 C4.38 IEC60695-11-5.

X-ON Electronics

Largest Supplier of Electrical and Electronic Components

Click to view similar products for [Film Capacitors](#) category:

Click to view products by [Dersonic](#) manufacturer:

Other Similar products are found below :

[M83421/01-3089R](#) [703-6G](#) [F450KG153J250ALH0J](#) [750-1018](#) [FKP1-1000160010P15](#) [FKP1-1500160010P15](#) [FKP1U024707E00KYSD](#)
[82EC1100DQ50K](#) [MMWAF150KME](#) [PCY2130F30153](#) [PME261JB5220KR19T0](#) [A521HH333M035C](#) [QXJ2E474KTPT](#) [QXL2B333KTPT](#)
[QXM2G104K](#) [B32234-.033@250V-K](#) [B32520C6332K000](#) [B32522C6104K000](#) [B32523Q3155J](#) [B32676E6755K](#) [B81133-C1104-M3](#)
[MTC355L1](#) [217-0716-001](#) [PA225L30](#) [221A10-120](#) [CB182K0184J--](#) [KP1830-247/061-G](#) [SCD105K122A3-22](#) [SCD205K122A3-24](#)
[F601BL225K063CL60A](#) [PCX2339F65224](#) [PCX2339F65334](#) [2222 368 55105](#) [2222 370 21683](#) [QXL2E473KTPT](#) [445450-1](#) [B32524Q6155J](#)
[46KI3100JBM1K](#) [MKP 1839-215-633](#) [MKP 1840-447-165](#) [MKP383510063JKP2T0](#) [MKT182022263473](#) [WMC08P22](#) [YE333](#) [ECQ-](#)
[W4223KZ](#) [EEC2G805HQA415](#) [PA103L30](#) [82DC3100DQ50J](#) [82EC2150DQ50K](#) [WMF1D68](#)