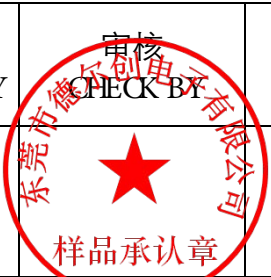

规格书  
SPECIFICATION

客户 CUSTOMER	立创
客户料号 CUSTOMER P/N	
规格描述 DESCRIPTION	100V/0.15UF/J/F5.08/直脚/L18/7.2*6.5*2.5/灰壳
产品编码 PART NUMBER	CFK2A154JC1F7B04UA00
日期 DATE	2024-05-22

德尔创承认栏 APPROVED BY DERSONIC			客户承认栏 APPROVED BY CUSTOMER	
批准 APPROVED BY	审核 CHECK BY	制订 FORMULATE BY	批准 APPROVED BY	审核 CHECK BY
				

东莞市德尔创电子有限公司

DONGGUAN DERSONIC ELECTRONIC CO., LTD.  
中国广东省东莞市寮步镇松湖智谷科技产业园2栋15楼  
15/F, Building 2, Songhu Zhigu Science and Technology Industrial Park,  
Liaobu Town, Dongguan City, Guangdong Province, China  
TEL: +86-769-8533 5208 FAX: +86-769-8155 5989  
Website: <http://www.dersonic.com>

## 1、 特点及用途:

### Characteristics and uses

该电容器采用外部阻燃壳式封装，环氧树脂灌封，自愈性好，可靠性高，损耗小，电性能优越，外形尺寸一致，适于自动化装配，可全系列径向编带，广泛应用于各种直流及脉动电路中。

The capacitor is encapsulated with exterior flame retardant shell and epoxy resin. It has good self-healing, high reliability, low loss, superior electrical performance, uniform shape and size. It is suitable for automatic assembly and can be used in all series of radial tapes. It is widely used in various DC and pulsating circuits.

## 2、 电性能:

### Electrical performance

<b>2.1</b>	引用标准 Reference criteria	GB/T15448 (IEC384-19)
<b>2.2</b>	气候类别 Climate Category	55/105/56
<b>2.3</b>	额定电压 Rated Voltage	63V/100V/250V/400V/630V
<b>2.4</b>	电容量 Capacitance	0.0001~2.2 $\mu$ F
<b>2.5</b>	耐电压 Withstand Voltage	1.6U <sub>R</sub> (5s)
<b>2.6</b>	容量偏差 Capacitance Tolerance	J: $\pm$ 5%    K: $\pm$ 10%    M: $\pm$ 20%
<b>2.7</b>	损耗角正切 Dissipation factor	$\leq$ 0.0100 (1KHz, 20 $^{\circ}$ C)

<p><b>2.8</b></p>	<p>绝缘电阻 Insulation Resistance</p>	<p><math>U_R \leq 100V</math> , <math>C_R \leq 0.33\mu F</math>, <math>\geq 3750M\Omega</math>  <math>C_R &gt; 0.33\mu F</math>, <math>\geq 1250S</math> (20°C, 1min)  <math>U_R &gt; 100V</math> , <math>C_R \leq 0.33\mu F</math>, <math>\geq 7500M\Omega</math>  <math>C_R &gt; 0.33\mu F</math>, <math>\geq 2500S</math> (20°C, 1min)</p>
<p><b>2.9</b></p>	<p>结构 structure</p>	<p>灌封环氧树脂, 阻燃塑壳封装。 Pouring epoxy resin, flame retardant plastic shell packaging</p>

### 3、外形图:

#### External shape

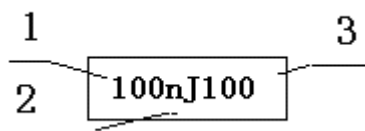
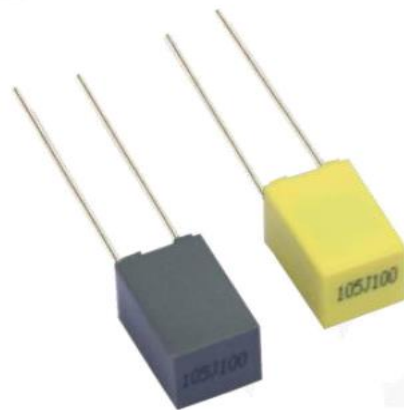
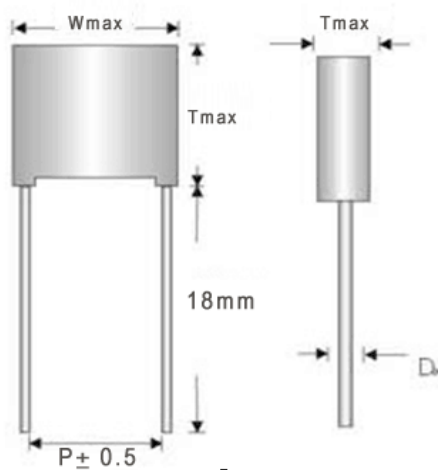

印字说明：顶部激光印字

Printing Description: Top Laser Printing

1 容量 2 容量误差 3 电压

1.Capacitance 2. Capacitance Tolerance 3. Rated Voltage

#### 4、外形尺寸 Shape size

额定电压 Rated Voltage (VDC)	标称容量 Capacitance ( $\mu\text{F}$ )	外形尺寸 External shape dimensions (mm)			脚距 Foot distance (mm)	线径 Line diameter (mm)
		电容器厚度 Capacitor Thickness	$\leq 3.5$	$> 3.5$		
		外形尺寸偏差(W.H.T) Dimension Tolerance	$\pm 0.2$	$\pm 0.4$		
		W	H	T		
100V	0.001	7.2	6.5	2.5	5	0.5
100V	0.0015	7.2	6.5	2.5	5	0.5
100V	0.0018	7.2	6.5	2.5	5	0.5
100V	0.0022	7.2	6.5	2.5	5	0.5
100V	0.0047	7.2	6.5	2.5	5	0.5
100V	0.0056	7.2	6.5	2.5	5	0.5
100V	0.0068	7.2	6.5	2.5	5	0.5
100V	0.0082	7.2	6.5	2.5	5	0.5
100V	0.01	7.2	6.5	2.5	5	0.5
100V	0.012	7.2	6.5	2.5	5	0.5
100V	0.015	7.2	6.5	2.5	5	0.5
100V	0.018	7.2	6.5	2.5	5	0.5
100V	0.022	7.2	6.5	2.5	5	0.5
100V	0.027	7.2	6.5	2.5	5	0.5
100V	0.047	7.2	6.5	2.5	5	0.5
100V	0.068	7.2	6.5	2.5	5	0.5
100V	0.082	7.2	6.5	2.5	5	0.5
100V	0.1	7.2	6.5	2.5	5	0.5
100V	0.15	7.2	6.5	2.5	5	0.5
100V	0.33	7.2	7.5	3.5	5	0.5
100V	0.47	7.2	7.5	3.5	5	0.5
100V	1.0	7.2	11	6	5	0.6
100V	1.5	7.2	11	6	5	0.6

#### 5、芯子结构图:

#### Core structure diagram



## 6、测试方法

### Measuring ways and means

no	测试项目 Items	测试器具 Appliance	IL	AQL	性能要求 Specifications
1	外观检查 Appearance inspecting	目测 All eyes	II	1.5	无可见损伤, 标志可辩 No damage, The marking shall be vindicable
2	尺寸 dimensions	游标卡尺 Vernier calipers			符合第 4 条规定 Compliance with Article 4
3	电 容 量 Capacitance	TE2617 型电容测试仪 TE2617 pattern testing instrument	II	1.0	符合 2.6 条 Clause 2.6 shall be satisfied
4	损耗角正切 Dissipation factor				符合 2.7 条 Clause 2.7 shall be satisfied
5	耐电压 (极间) Voltage proof	耐电压测试仪 CJ2672S 型 CJ2672S pattern voltage proof testing instrument			按 2.5 条无击穿或飞弧 Clause 2.5 shall be satisfied, there shall be no dielectric breakdown or other damage.
6	绝缘电阻 (极间) Insulation resistance(the leads)	绝缘电阻测试仪 TH2681A 型 TH2681A pattern Insulation resistance testing instrument			符合 2.8 条 Clause 2.8 shall be satisfied

注 Note:

1) 具体测试参照 GB/T2693-2001, 测试器具可用功能相同的其他型器具。

Detailed Measuring ways and means refer to GB/T2693-2001, measure appliance may be replaced by the others as same function.

2) IL、AQL 检查水平选自 GB/T2828.1-2003。The check standard select from GB/T2828.1-2003.

3) 电容量、损耗角正切测试电压:  $\leq 1.8V_{rms}$ 。

The testing voltage of Capacitance, Dissipation factor:  $\leq 1.8V_{rms}$ .

4) 绝缘电阻测试电压:  $10V(U_R < 100V)$ ;  $100V(100V \leq U_R < 500V)$ ;  $500V(U_R \geq 500V)$

The testing voltage of Insulation resistance:  $10V(U_R < 100V)$ ;  $100V(100V \leq U_R < 500V)$ ;  $500V(U_R \geq 500V)$ .

## 7、试验方法及性能

### Test method and performance

#### 7.1 稳态湿热试验:

试验温度:  $40 \pm 2^\circ C$

相对湿度:  $93 \pm 2\%$

试验时间: 21 天

试验判据:

电容量变化率:  $\leq$  初始测试值的  $\pm 5\%$

损耗角正切: 增加值  $\leq 0.005$  (1KHz)

绝缘电阻:  $\geq$  初始规定值的 50%

7.1 HUMIDITY TEST CONDITIONS:

TEST TEMPERATURE:  $40 \pm 2^{\circ}\text{C}$

RELATIVE HUMIDITY:  $93 \pm 2\%$

TEST DURATION: 21DAYS

TEST CRITERIA:

CAPACITANCE DRIFT:  $\cong \pm 5\%$  OF THE INITIAL VALUE.

DISSIPATION FACTOR:  $\cong 0.005$  (1KHZ)

INSULATION RESISTANCE:  $\cong 50\%$  OF INITIAL SPECIFIED VALUE.

7.2 耐久性试验:

试验温度:  $85 \pm 2^{\circ}\text{C}$

试验电压:  $1.25U_r$

试验持续时间: 1000 小时

试验判据:

电容量变化率:  $\cong$  初始值的  $\pm 8\%$

损耗角正切: (增加值)  $\cong 0.005$  (1KHz)

绝缘电阻:  $\cong$  初始值的 50%

7.2 LIFE TEST CONDITIONS:

TEST TEMPERATURE:  $85 \pm 2^{\circ}\text{C}$

TEST VOLTAGE:  $1.25U_r$

TEST DURATION: 1,000HOURS

TEST CRITERIA:

CAPACITANCE DRIFT:  $\cong \pm 8\%$  OF THE INITIAL VALUE

DISSIPATION FACTOR(INCREASE):  
 $\cong 0.005$  (1KHz)

INSULATION RESISTANCE:  $\cong 50\%$  OF SPECIFIED VALUE

7.3 可焊性试验:

焊槽温度:  $235 \pm 5^{\circ}\text{C}$

焊料成份: 锡 99.96% + 银 0.04%

浸入时间:  $2 \pm 0.5$  秒

试验判据: 引线表面 90%锡被复盖

7.3 SOLDERABILITY CONDITIONS:

SOLDER BATH TEMPERATURE:  $235 \pm 5^{\circ}\text{C}$

SOLDER MATERIAL: 99.96% OF TIN + 0.04% OF ARGENTINE

SOLDER TIME :  $2 \pm 0.5$  SEC

TEST CRITERIA : 90% OF THE SURFACE TINNING

**7.4 耐焊接热试验:**

根据 IEC60068 Td 试验之条件:

焊接温度:  $260 \pm 5^{\circ}\text{C}$

浸入时间:  $10 \pm 1$  秒

电容器本体与焊料之间用 PC 板隔离

试验判据:

产品外观: 引线镀锡层无可见损伤.

电容量变化率:  $\leq$  初始值的  $\pm 2\%$

损耗角正切: (增加值)  $\leq 0.003(1\text{KHz})$

绝缘电阻:  $\geq$  初始规定值的  $50\%$

**7.4 SOLDERING HEAT RESISTANCE:**

**IN ACCORDANCE WITH IEC60068 Td TEST  
CONDITIONS:**

**SOLDER BATH TEMPERATURE:  $260 \pm 5^{\circ}\text{C}$**

**SOLDER TIME :  $10 \pm 1$  SEC.**

**CAPACITANCE BODY MAY LIE ON PRINTING  
CIRCUIT BOARD**

**TEST CRITERIA;**

**APPEARANCE: NO DAMAGE AND GOOD  
TINNING**

**CAPACITANCE CHANGE:  $\leq \pm 2\%$**

**DISSIPATION FACTOR(INCREASE ):  
 $\leq 0.003 (1\text{KHz})$**

**INSULATION RESISTANCE:  $\geq 50\%$  OF SPECIFIED VALUE**

**7.5 干热试验:**

根据 IEC600 68-2-2 试验 Ba 之条件:

试验温度:  $85 \pm 2^{\circ}\text{C}$

试验时间: 16 小时

试验判据:

(1) 外观: 无可见损伤及渗出物

(2) 电容量变化:  $\leq$  初始测试值的  $\pm 5\%$

**7.5 DRY "HEAT" RESISTANCE :**

**IN ACCORDANCE WITH IEC600 68-2-2 TEST Ba  
CONDITIONS :**

**TEST TEMPERATURE :  $85 \pm 2^{\circ}\text{C}$**

**TEST DURATION : 16 HOURS**

**TEST CRITERIA :**

**(1) APPEARANCE : NO VISIBLE DAMAGE AND NO  
LEAKAGE.**

**(2) CAPACITANCE CHANGE :  $\leq \pm 5\%$  OF THE INITIAL  
VALUE**

**7.6 寒冷试验:**

根据 IEC60068-2-1 试验 Aa 之条件:

试验温度:  $-55 \pm 2^{\circ}\text{C}$

试验时间: 2 小时

试验判据:

(1) 外观: 无可见损伤

(2) 电容量变化率:  $\cong$  初始测量值的  $\pm 10\%$

**7.6 COLD RESISTANCE**

**IN ACCORDANCE WITH IEC 68-2-1 TEST Aa  
CONDITIONS**

**TEST TEMPERATURE :  $- 55 \pm 2^{\circ}\text{C}$**

**TEST DURATION : 2 HOURS**

**TEST CRITERIA :**

**(1) APPEARANCE : NO VISIBLE DAMAGE**

**(2) CAPACITANCE CHANGE :  $\cong \pm 10\%$  OF THE INITIA**

**7.7 循环湿热试验:**

根据 IEC60068-2-30 试验 Db

试验温度:  $+55 \pm 2^{\circ}\text{C}$

试验湿度: 90%~95%R.H

持续时间: 5 个循环(24 小时为一个循环)

试验后,允许电容器在正常的温度与湿度下放置 1~2 小时  
再进行测试.

试验判据:

(1) 容量变化  $\leq +5\%$

(2) 损耗变化(增加值)  $\leq 0.005$

(3) 绝缘电阻:  $\cong$  初始规定值的 50%

**7.7 DAMP HEAT CYCLE TEST:**

**IN ACCORDANCE WITH IEC60068-2-30 TEST Db**

**TEST TEMPERATURE T:  $+55 \pm 2^{\circ}\text{C}$**

**TEST HUMIDITY: 90%~95%R.H**

**TEST DURATION: FIVE CYCLES( ONE CYCLE FOR  
24HRS)**

**AFTER TEST, ALLOW IT STAY ALONE FOR 1~2HRS AT  
STANDARD TEMP AND HUMIDITY BEFORE MAKING  
MEASUREMENTS.**

**TEST CRITERIA:**

**(1) CAPACITANCE CHANGE :  $\cong +5\%$  OF THE INITIAL  
VALUE**

**(2) DISSIPATION FACTOR(INCREASE):  $\leq 0.005$**

**(3) INSULATION RESISTANCE :  $\cong 50\%$  OF INITIAL  
SPECIFIED VALUE**



7.8 温度快速变化试验:

QA= -55°C 0.5h

QB= +85°C 0.5h

按 IEC60384-1 4.16 条从负温 QA 到正温 QB 中间转换时 30 分钟（为一次循环）共 5 次.

试验判据:

(1)外观:无可见损伤.

(2)电容量变化:  $\leq$  初始测试值的  $\pm 5\%$

(3)损耗角正切(增加值):  $\leq 0.005$

7.8 RAPID CHANGE OF TEMPERATURE:

QA= -55°C 0.5h

QB= +85°C 0.5h

IN ACCORDANCE WITH IEC60384-1 4.16 TRANSFORMING TIME 30 MIN FROM LOWER TEMPERATURE QA TO UPPER TEMPERATURE QB (AS ONE CYCLE), FIVE CYCLES IN ALL.

TEST CRITERIA:

(1) APPEARANCE :NO VISIBLE DAMAGE

(2) CAPACITANCE CHANGE :  $\leq \pm 5\%$  OF THE INITIAL VALUE

(3) DISSIPATION FACTOR(INCREASE):  $\leq 0.005$

(4)INSULATION RESISTANCE :  $\geq 50\%$  OF INITIAL SPECIFIED VAL

7.9 引出端强度试验:

根据 IEC600 68-2-21 试验 Ua.1 之条件:

引出端 抗张强度 持续时间

直径(mm) KG(N) 秒

>0.5 TO  $\leq 0.8$  1.0(10) 10

>0.8 2.0(20) 20

试验判据:

引线无破裂,电容本部无损

7.9 TENSILE STRENGTH OF TERMINALS

IN ACCORDANCE WITH IEC600 68-2-21 TEST Ua.1  
CONDITIONS.

TERMINAL LOAD FORCE HOLDING  
TIMES

DIA. (mm) KG (N) SEC.

>0.5 TO ≤0.8 1.0 (10) 10

>0.8 2.0 (20) 20

TEST CRITERIA:

NO WIRE BREAKAGE AND NO DAMAGE OF CAPACITOR.

7.10 引出端弯曲强度试验:

根据 IEC600 68-2-21 试验 Ub 之条件:

抗弯曲强度: 0.5Kg(5N)

弯曲时间: 左右两边连续弯曲(4×90 度)

试验判据:

引线无破裂,电容本体无损伤

7.10 BENDING OF TERMINALS

IN ACCORDANCE WITH IEC 60068-2-21 TEST Ub.  
CONDITIONS

LOAD FORCE : 0.5 KG (5N)

BENDING TIME : TWO CONSECUTIVE BENDS (4 \* 90 C)

TEST CRITERIA :

NO WIRE BREAKAGE AND NO DAMAGE OF CAPACITOR

7.11 充放电试验:

周期: 10000 次

充电持续时间: 1.0 秒

放电持续时间: 1.0 秒

试验判据:

电容量变化率: ≅ 初始测量值的 ±5%

损耗角正切: (增加值) ≅ 0.003(10KHz)

绝缘电阻: ≅ 初始规定值的 50%

7.11 CHARGE AND DISCHARGE:

CYCLE TIME:10000TIMES t

CHARGE LASTING TIME:1.0S

DISCHARGE LASTING TIME:1.0S

TEST CRITERIA :

CAPACITANCE CHANGE :  $\cong \pm 5\%$  OF THE INITIAL

DISSIPATION FACTOR(INCREASE ): $\cong 0.003$  (10KHz)

INSULATION RESISTANCE :  $\cong 50\%$  OF INITIAL SPECIFIED VALUE

8、典型的电容器特性曲线图:

Typical Characteristic Curves of Capacitors

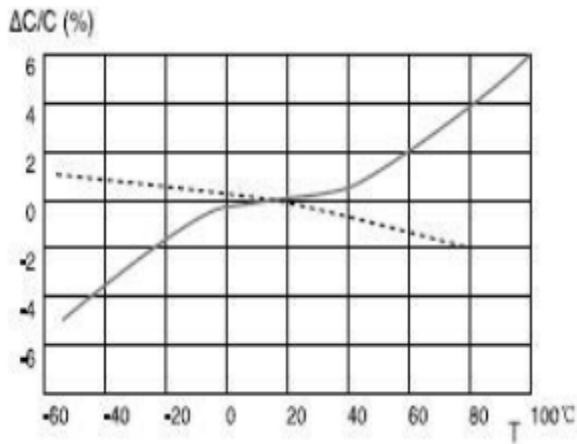

容量与温度曲线图

Capacity and temperature curve

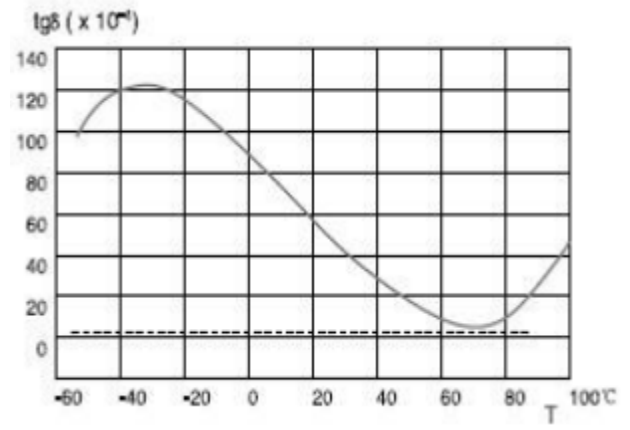

损耗角正切与温度曲线图

Dissipation and temperature curve

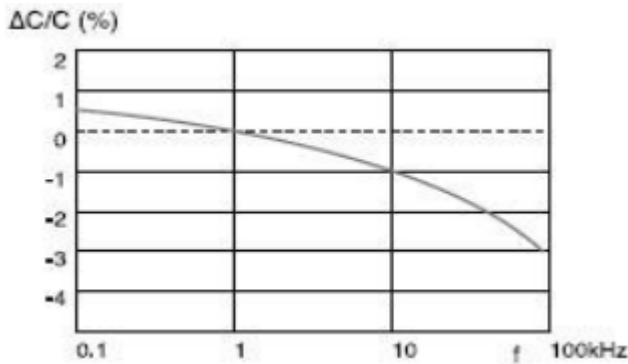

容量与频率曲线图

Capacity and frequency curve

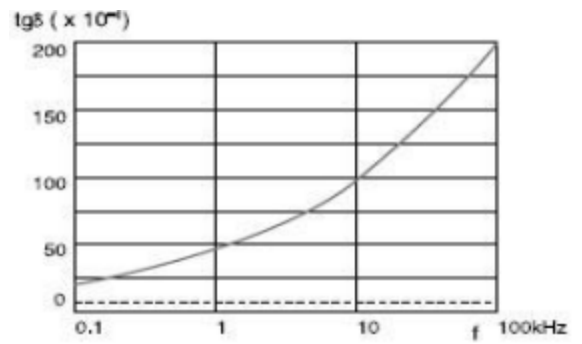

损耗角正切与频率曲线图

Dissipation and frequency curve

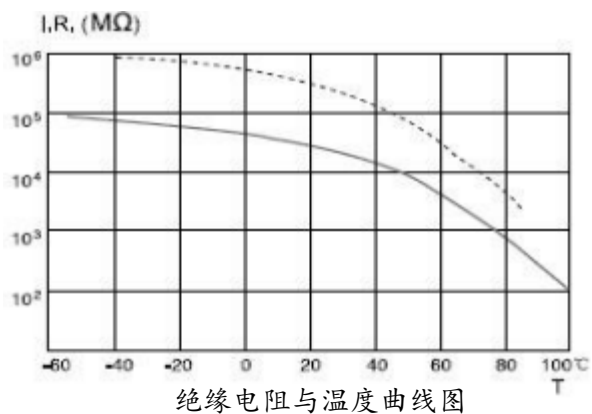

Insulation resistance and temperature curve

9、编带形状及尺寸要求如图：

**Shape and Dimension Requirements of Braided Tape**

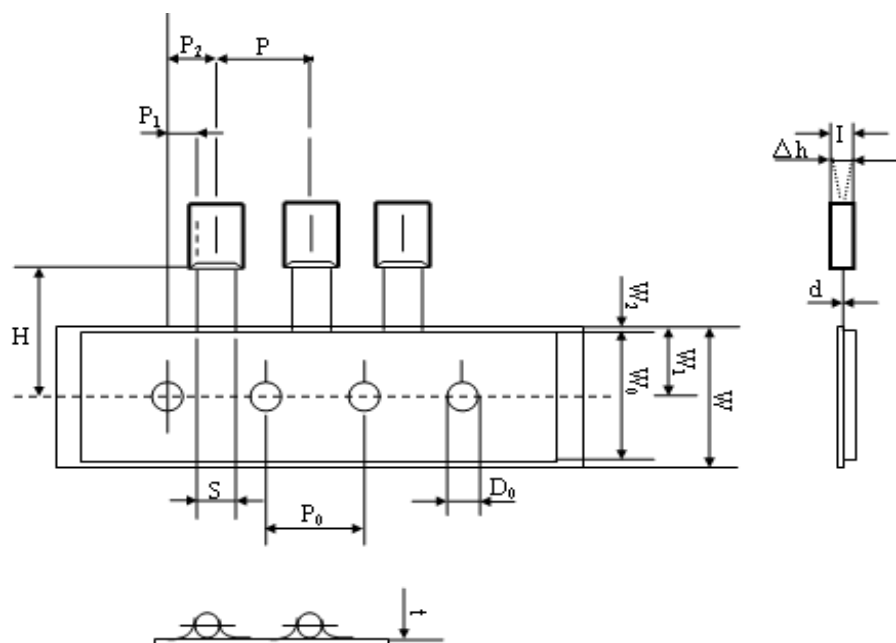

名称 Name	标记 sign	尺寸 size (mm)
电容器间距 Capacitor spacing	P	$12.7 \pm 1.0$
插孔间距 Socket spacing	$P_0$	$12.7 \pm 0.3$
插孔位置及偏差 Position and deviation of Jack	$P_1$	$3.85 \pm 0.7$
	$P_2$	$6.35 \pm 1.3$
	$W_1$	$9.0 \pm 0.5$
引线间距 Lead spacing	S	$5.0_{-0.2}^{+0.6}$
产品歪斜度 Product skewness	$\Delta h$	$\pm 1.0$
纸带宽 Paper bandwidth	W	$18.0 \pm 0.5$
产品下线高度 Product Offline Height	H	$18 \pm 0.5$
插孔直径 Jack diameter	D0	$4.0 \pm 0.2$
编带总厚度 Total Tape Thickness	t	$0.7 \pm 0.2$
胶带宽 tape width	$W_0$	10max
胶带位置偏移 Belt position offset	$W_2$	0~3

## 产品应用说明

### Product application note

1. 超温使用时额定电压降低: (温度每超过 1°C, 使用电压下降 1.25%\*Ur)

1. The rated voltage is reduced when using over temperature: (every temperature exceeds 1 ° C, the voltage drops by 1.25%\*Ur)

由于薄膜电容器的工作温度（电容器最热点测量的温度）依赖于电容器所使用的介质膜，因此，电容器环境温度与电路电压的类型（AC、DC）、脉冲电流的种类和频率有关。

Since the operating temperature of the film capacitor (the temperature at which the most hot spot of the capacitor is measured) depends on the dielectric film used by the capacitor, the ambient temperature of the capacitor is related to the type of circuit voltage (AC, DC), the type and frequency of the pulse current.

额定电压是指在电容器可以连续使用时产生的温度 $\leq$ 额定温度时的最高电压。对于应用于高于额定温度条件的电容器，额定电压必须有一个减额来弥补由于高温而造成的介质损坏。

The rated voltage is the highest voltage at the temperature  $\leq$  rated temperature generated when the capacitor can be used continuously. For capacitors used above rated temperature conditions, the rated voltage must have a deduction to compensate for media damage due to high temperatures.

这个减额根据使用的薄膜不同而不同。（详见图表）

This deduction varies depending on the film used. (see chart for details)

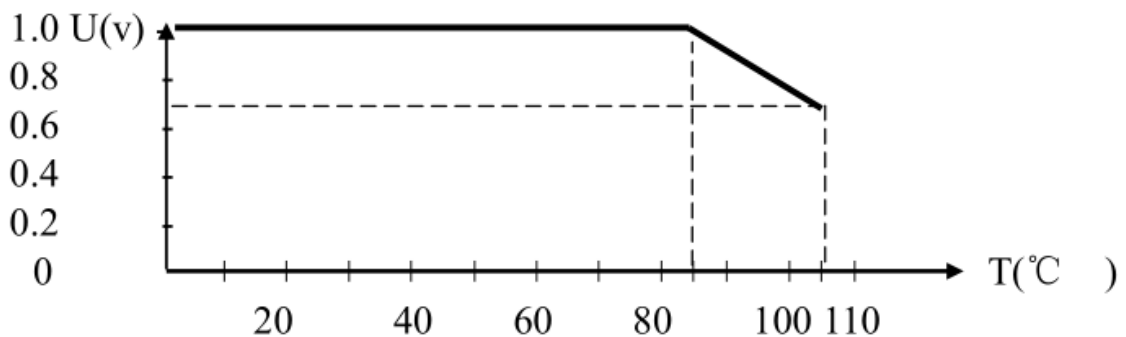

## X-ON Electronics

Largest Supplier of Electrical and Electronic Components

*Click to view similar products for [Film Capacitors](#) category:*

*Click to view products by [Dersonic](#) manufacturer:*

Other Similar products are found below :

[703-6G](#) [82DC4100CK60J](#) [82EC1100DQ50K](#) [MMWAF150KME](#) [PCY2130F30153](#) [QXJ2E474KTPT](#) [QXL2B333KTPT](#) [QXM2G104K](#)  
[DPM16S56K-1F](#) [EEC2G505HQA406](#) [B32234-.033@250V-K](#) [B81133-C1104-M3](#) [MTC355L1](#) [217-0716-001](#) [PA225L30](#) [CB182K0184J--](#)  
[KP1830-247/061-G](#) [274ACF4400WA0J](#) [274ACF5150WA0J](#) [SCD105K122A3-22](#) [SCD205K122A3-24](#) [PCX2339F65224](#) [PCX2339F65334](#)  
[2222 368 55105](#) [2222 370 21683](#) [QXL2E473KTPT](#) [445450-1](#) [MKT182022263473](#) [46KN410000N1K](#) [46KR368050M1M](#) [ECQ-W4223KZ](#)  
[EEC2G805HQA415](#) [PA103L30](#) [82DC4100AA60K](#) [82EC2150DQ50K](#) [VEA105K50](#) [82IC2150DQ50J](#) [82EC2220DQ50J](#) [MTC55L4](#)  
[MTC56L4](#) [PA104L30](#) [PA224L30](#) [82DC3220AA60J](#) [82EC4100DQ70J](#) [WYP-104M](#) [82CC4220AA70J](#) [82EC3100Z370J](#) [B32656S8105K566](#)  
[EEC2G105HQA401](#) [QXL2B223KTPT](#)