

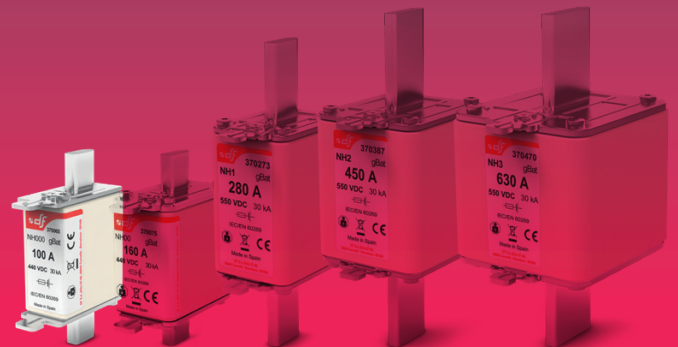

gBat

NH 440V DC

fuse links



**PROTECTING
THE WORLD**





RATED VOLTAGE
440V DC

RATED CURRENT
20A...100A

BREAKING CAPACITY
30kA

STANDARDS

IEC/EN 60269-1
IEC 60269-7 DRAFT

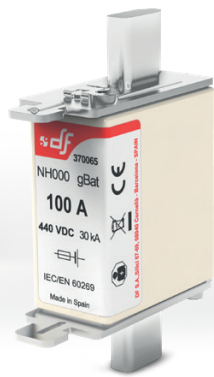

NH gBat 440/550V DC fuse links for battery storage protection

NH gBat fuse links are specially designed to protect battery systems according to the draft of the new Standard IEC60269-7.

NH gBat fuse links are capable of clearing all types of overcurrents, overloads and short-circuits, thus the fuse links protect the batteries as well as cables and all switchgear of installation.

These fuse links are designed and manufactured with the same techniques that semiconductor fuse links, which makes them very fast of operation and gives a good performance under continuous charge/discharge cycles.

They are optimized to have reduced power dissipations that allow the utilization of a wide range of fuse bases, disconnectors and fuse switch disconnectors.

The range comprises the following fuse links:

→ Size NH000 gBat 440V DC 20A to 100A

These fuse links can be used also as a protection in other DC applications, but it is very important to take into account the kind of load and the time-constant of circuit in order to have a correct application (consult us).

They are manufactured according to IEC/EN60269 Standards and comply with RoHS directive.



Range

I_n (A)	REFERENCE	PACKING Uni /BOX
20	370025	3/90
25	370030	3/90
32	370035	3/90
40	370045	3/90
50	370050	3/90
63	370055	3/90
80	370060	3/90
100	370065	3/90



Technical data

Rated voltage	440V DC L/R ≤ 10ms
Rated current	20A...100A
Rated breaking capacity	30kA
Utilization category	gBat
Storage temperature	-40°C ... 90°C
Operating temperature *	-40°C ... 80°C

* For ambient temperatures higher than 25°C it is necessary to apply a derating in maximum current.

Materials

Body	Steatite C221
Contact blades	Copper or brass (silver plated)
Plates	Aluminium
Screws	Zinc plated steel

Ambient temperature derating factor

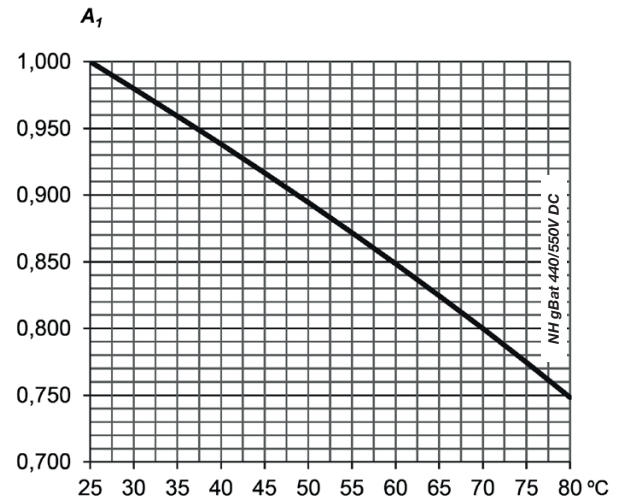

Standards

IEC/EN 60269-1
IEC 60269-7 (draft)
RoHS Compliant





Dimensions

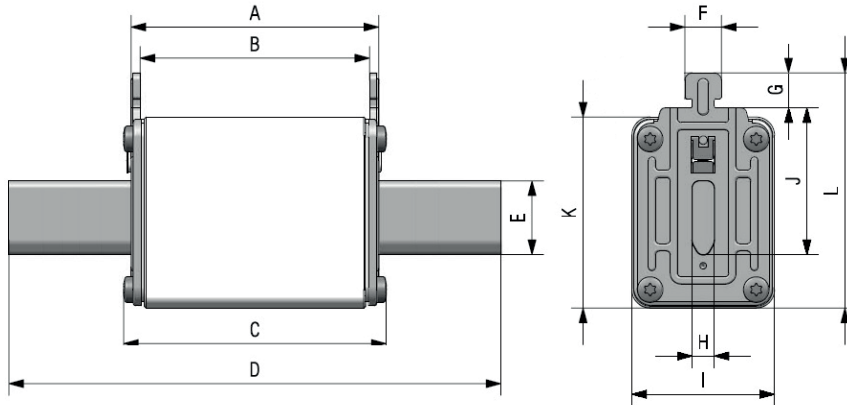

A	B	C	D	E	F	G	H	I	J	K	L	Weight
49	45	52	78,5	15	10	9,5	6	21	35	40	53	120 gr

t-I characteristics

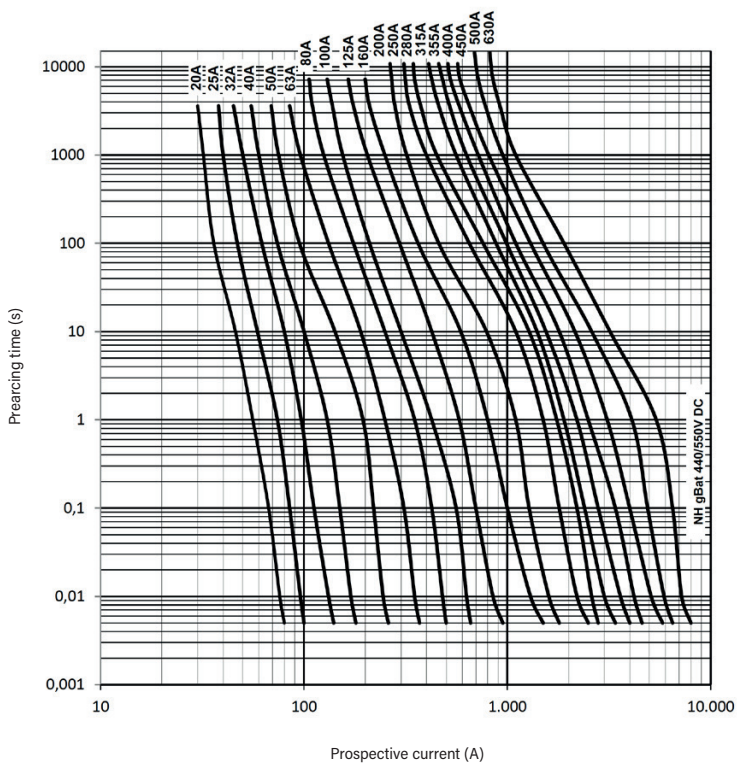

Cut-off characteristics

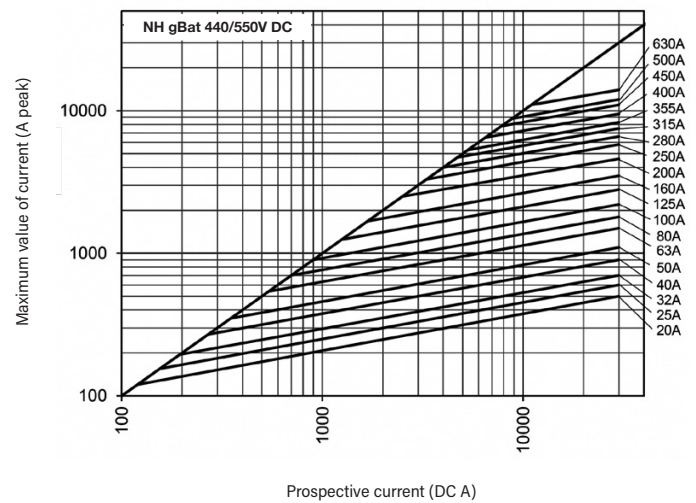



Power dissipation

RATED CURRENT (A)	POWER LOSS $0,8 \cdot I_n$ (W)	POWER LOSS I_n (W)	PREARCING I^2t (A ² s)	OPERATING I^2t at U_n (A ² s)
20	2,9	5,1	40	60
25	3,2	5,6	65	90
32	3,9	6,6	125	175
40	4,2	7,2	250	355
50	5,1	8,5	425	600
63	5,3	9,1	1000	1400
80	6,3	11	1850	2575
100	7,6	13,3	3300	4600

Correction factor for power loss

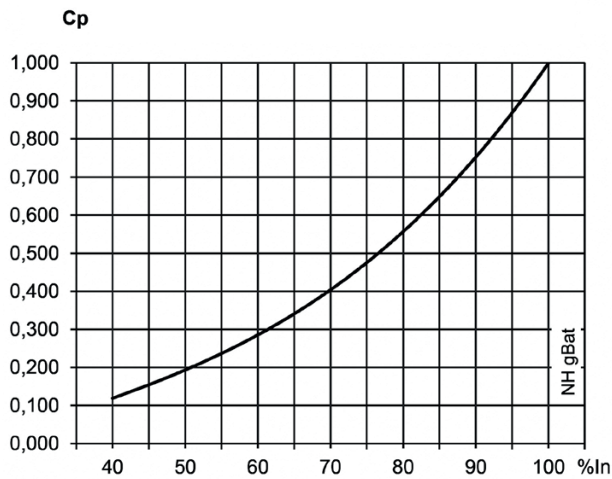



HEAD OFFICE AND FACTORY

SILICI, 67-69
08940 CORNELLA DE LLOBREGAT
BARCELONA
SPAIN
Tel. +34 93 377 85 85
Fax +34 93 377 82 82

INTERNATIONAL SALES

Tel. +34 93 475 08 64
Fax +34 93 480 07 75
export@dfelectric.es

NATIONAL SALES

Tel. 93 475 08 64
Fax 93 480 07 76
comercial@dfelectric.es

dfelectric.es

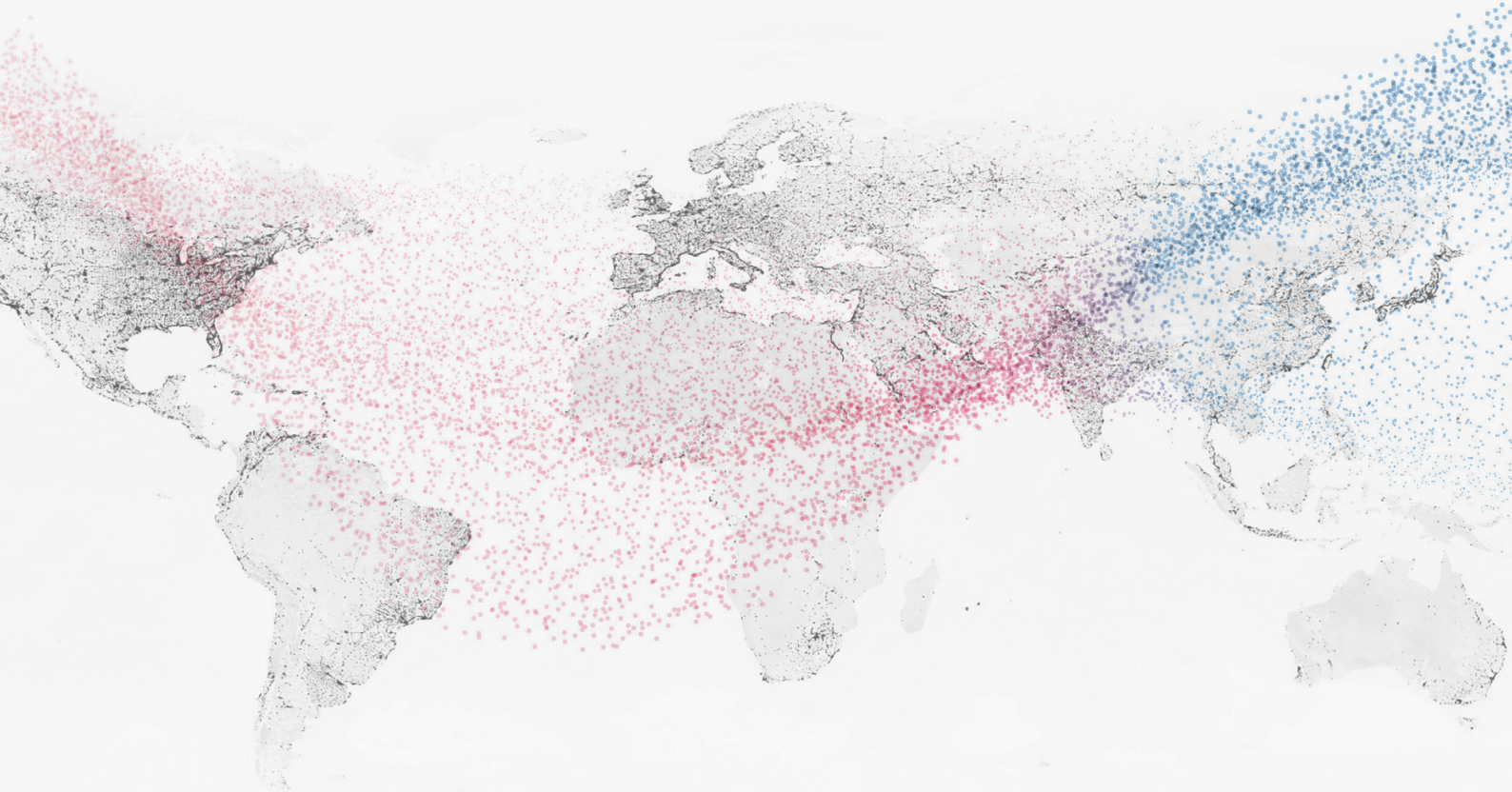

The data reflected in this technical record are subject to the correct installation of the product in accordance with manufacturer's instructions, relevant installation standards and professional practices, maintained and used in applications for which they were made.

The products described in this document have been designed, developed and tested in accordance with specific standard. They are considered components that are integrated as part of installation, machine or equipment. The correct general operation of the referred product is responsibility of the manufacturer of the installation, machine or equipment.

DF ELECTRIC cannot guarantee the characteristics of an installation, machine or equipment that has been designed by a third party. Once a product has been selected, the user must verify that it is appropriate for its application, through the verifications and/or tests that it deems appropriate.

DF ELECTRIC retains the right to change the dimensions, specifications, materials or design of its products at any time with or without notice.



PROTECTING THE WORLD



X-ON Electronics

Largest Supplier of Electrical and Electronic Components

Click to view similar products for [Industrial & Electrical Fuses](#) category:

Click to view products by [DF Electric](#) manufacturer:

Other Similar products are found below :

[MTH-8](#) [BP/NON-30](#) [NLN2](#) [NLN25](#) [KTN-R-10](#) [FLSR100](#) [BLF6](#) [KLK003](#) [NLS10](#) [TCF100RN](#) [382000](#) [382010](#) [382015](#) [382030](#) [381455](#)
[381325](#) [381390](#) [382110](#) [382115](#) [382120](#) [382125](#) [384510](#) [397180](#) [397270](#) [365025](#) [365030](#) [365035](#) [365045](#) [365050](#) [365055](#) [365060](#)
[365065](#) [365070](#) [365075](#) [365080](#) [365085](#) [365225](#) [365230](#) [365235](#) [365240](#) [365245](#) [365260](#) [365270](#) [365280](#) [365282](#) [365290](#) [365350](#)
[365360](#) [365370](#) [365380](#)