

TR21 CONTROL

single-phase transformers

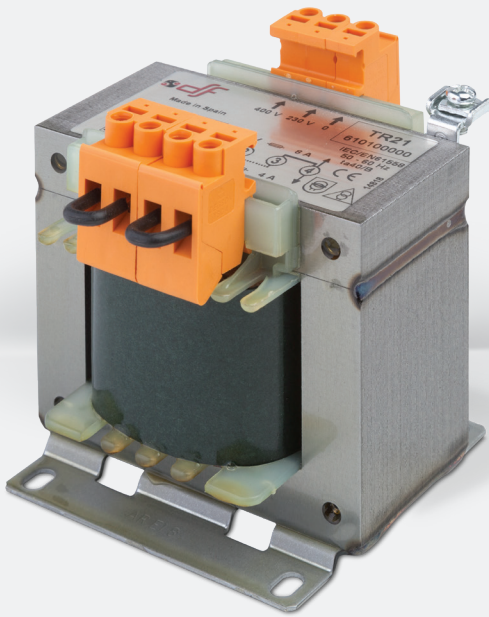

**PROTECTING
THE WORLD**



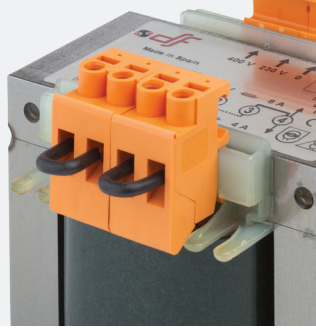

TR21

POWER
40VA...1000VA

PRI VOLTAGE
0-230-400V

SEC VOLTAGE
12-24V
24-48V
115-230V

STANDARDS

IEC/EN 61558-1
IEC/EN 61558-2-2
IEC/EN 61558-2-4
IEC/EN 61558-2-6

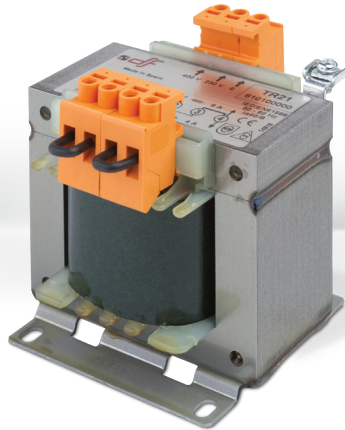

TR21 CONTROL Single-phase transformers

TR21 type transformers are intended for use as control or signalling transformer as well as general use transformer.

The range comprises rated power between 40VA to 1000VA.

They have been designed with low impedance windings for excellent voltage regulation, and for accommodate the high momentary inrush current caused when electromechanical devices are energized.

They are sized for continuous service at 100% of power in an ambient temperature up to 40°C. For ambient temperatures above 40°C it is necessary to apply a derating.

Great versatility due to the double voltage in primary as well as secondary windings.

Primary voltage 230-400 V according standard values in IEC60038. These transformers can withstand an input overvoltage of up to 10%.

Secondary windings comprise two identical windings intended to serial or parallel connection, thus the user can obtain full power in any selected voltage. Possibilities are: 12-24V, 24-48V or 115-230V.





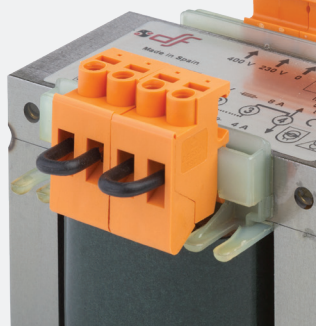

TR21 transformers are delivered with parallel connection (lower voltage).

Range

POWER (VA)	REFERENCE		
	12-24V	24-48V	115-230V
40	610040000	610040001	610040002
63	610063000	610063001	610063002
100	610100000	610100001	610100002
160	610160000	610160001	610160002
200	610200000	610200001	610200002
250	610250000	610250001	610250002
320	610320000	610320001	610320002
400	610400000	610400001	610400002
500	610500000	610500001	610500002
630	610630000	610630001	610630002
800	610800000	610800001	610800002
1000	611000000	611000001	611000002



Technical data

Use	SEC 12-24V Control and safety transformer	  
	SEC 24-48V 115-230V Control and isolating transformer	  
Rated primary voltage	0-230-400V	
Rated secondary voltage	12-24V 24-48V 115-230V	
Rated power range	40VA ... 1000VA	
Protection against electric shock	Class I	
Thermal class	B (130°C)	
Rated ambient temperature	40°C	
Protection index	IP00	
Frequency	50/60Hz	
Dielectric strength between primary and secondary	≥4,5kV	
Dielectric strength between windings and metallic parts	≥2,5kV	
Ambient temperature of service *	-20°C ... 70°C	
Storage temperature	-40°C ... 85°C	

* For ambient temperatures higher than 40°C it is necessary to apply a derating.

Standards

IEC/EN 61558-1 Transformers, general specifications
 IEC/EN 61558-2-2 Control transformers
 IEC/EN 61558-2-4 Isolating transformers
 IEC/EN 61558-2-6 Safety transformers
 RoHS Compliant



Dimensions

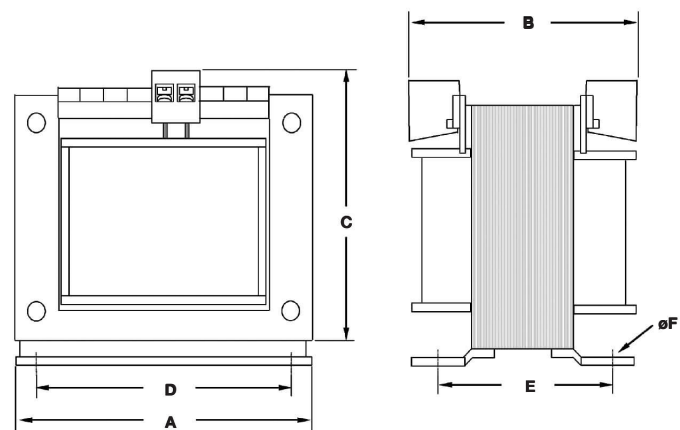

Constructive characteristics

Two identical secondary winding intended for serial or parallel connection (jumpers supplied with the transformer)

Reinforced insulation

Windings in F(155°C) or H(180°C) thermal class

Flexible insulation Class B (130°C)

Impregnation Class F (155°C)

Connections with accidental contact protected terminal blocks

Screw earth connection (standard IEC/EN61558 prescribes in the clause 24 that it should not be possible to loosen the protection wire without the aid of a tool)

TIG welded magnetic core prevent vibration and allows small air gap to reduce the magnetization current

POWER (VA)	DIMENSIONS (mm)						WEIGHT (kg)
	A	B	C	D	E	F	
40	75	83	88	56	47	4,8	1,00
63	84	86	95	64	52	4,8	1,40
100	84	100	95	64	67	4,8	1,96
160	96	102	106	84	77	5,7	2,80
200	96	116	106	84	91	5,7	3,40
250	108	105	115	80,5	73	5,7	3,64
320	108	117	115	80,5	87	5,7	4,54
400	120	110 ⁽¹⁾	124 ⁽²⁾	90	87	5,7	5,20
500	120	126 ⁽¹⁾	124 ⁽²⁾	90	107	5,7	6,85
630	150	114 ⁽¹⁾	146 ⁽²⁾	122	92	6,8	7,50
800	150	133 ⁽³⁾	146 ⁽⁴⁾	122	108	6,8	10,2
1000	150	156 ⁽³⁾	146 ⁽⁴⁾	122	135	6,8	13,6

⁽¹⁾ SEC 12V - 24V → + 20mm

⁽²⁾ SEC 12V - 24V → + 7,5mm

⁽³⁾ SEC 12V - 24V / SEC 24V - 48V → + 20mm

⁽⁴⁾ SEC 12V - 24V / SEC 24V - 48V → + 7,5mm

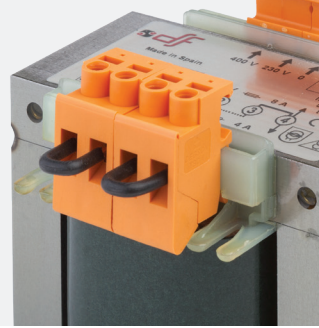

Secondary connection

* TRANSFORMER 0-230-400V // 24-48V 100VA
REF 610100001

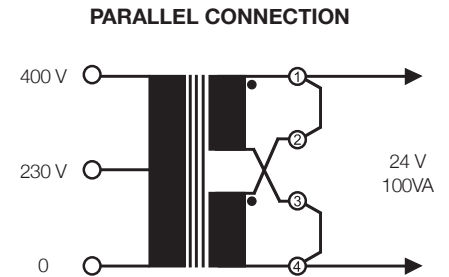
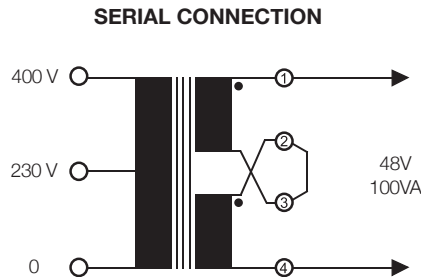

Typical values

RATED POWER	NO-LOAD CURRENT	NO-LOAD LOSSES	TOTAL LOSSES	U _{cc}	EFFICIENCY	VOLTAGE DROP
(VA)	I ₀ (% I _n)	P _{FE} (W)	P _{CU} + P _{FE} (W)	(%)	(%)	(%)
40	35	2,4	6,9	9,8	81	9,8
63	30	3,5	9,3	8,7	83	9,8
100	28	4,5	13,2	8,3	83	7,5
160	26	6,3	17,9	6,7	86	6,5
200	24	7,2	18,6	5,5	87	6,5
250	22	6,5	24,1	6,9	89	7,9
320	19	9,3	31,2	6,9	89	7,9
400	17	10,8	28,5	4,4	90	6,0
500	16	14,3	31,9	3,6	91	6,0
630	14	17,0	47,2	4,7	92	3,8
800	13	22,3	52,9	4,0	92	3,8
1000	11	27,1	59,7	3,3	94	3,8

Instantaneous power

RATED POWER	Cos φ	Cos φ	Cos φ	Cos φ	Cos φ	Cos φ	Cos φ	Cos φ	Cos φ	Cos φ
(VA)	0,1	0,2	0,3	0,4	0,5	0,6	0,7	0,8	0,9	1
40	221	146	110	91	75	63	55	51	47	44
63	414	274	207	170	140	118	104	96	89	82
100	682	440	327	263	220	185	163	150	135	121
160	1170	755	562	447	380	324	285	254	231	216
200	1323	847	656	530	450	392	350	312	286	270
250	1912	1224	949	765	650	566	505	452	413	390
320	2500	1600	1240	1000	850	740	660	590	540	510
400	2438	1757	1389	1160	1000	875	785	695	660	640
500	3413	2460	1945	1625	1400	1225	1100	975	925	895
630	3440	2622	2145	1840	1600	1430	1294	1192	1124	1090
800	5430	4095	3283	2753	2400	2120	1906	1765	1625	1588
1000	8000	5850	4625	3865	3300	2970	2607	2376	2178	2112

Maximum output delivered at a different values of power factor (cos φ)
for a short time and for a output voltage of at least 0,95·U_n

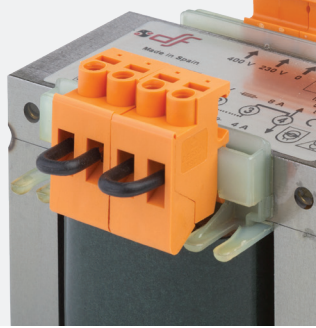

Transformer protection

The transformers (and their lines) must be protected against overloads and/or short-circuits that they can be submitted in use, and could cause dangerous situations for persons, animals or installations.

On the primary side, rated current of fuse links should be selected to withstand high values of inrush currents.

On secondary side, rated currents of fuse links should be selected in order to guarantee protection against short-circuits as well as overloads.

For rated currents up to and including 6,3A we can use 5x20 or 6x32 fuses according to IEC/EN60127. The characteristics (fast, slow, etc.) it depends of the load.

For rated currents above 6,3 A the adequate type of fuse links are those according to IEC/EN60269-2-1 (class gG).



Rated current of fuse links

PROTECTION ON PRIMARY SIDE

PROTECTION ON SECONDARY SIDE

POWER (VA)	INPUT VOLTAGE		OUTPUT VOLTAGE				
	230V	400V	12V	24V	48V	115V	230V
40	T630 mA	T315 mA	3,15 A	1,6A	800mA	315mA	160mA
63	T1 A	T500 A	5A	2,5A	1,25A	500mA	250mA
100	T1,6 A	T800 mA	8A	4A	2A	800mA	400mA
160	T2,5 A	T1,25 A	12A	6,3A	3,15A	1,25A	630mA
200	T3,15 A	T1,6 A	16A	8A	4A	1,6A	800mA
250	T4 A	T2 A	20A	10A	5A	2A	1A
320	T5 A	T2,5 A	25A	12A	6,3A	2,5A	1,25A
400	T6,3 A	T3,15 A	32A	16A	8A	3,15A	1,6A
500	8A gG	T4 A	40A	20A	10A	4A	2A
630	10A gG	T5 A	50A	25A	12A	5A	2,5A
800	12A gG	T6,3 A	63A	32A	16A	6,3A	3,15A
1000	16A gG	8A gG	80A	40A	20A	8A	4A

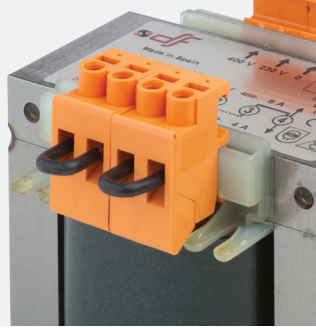

Selection guide

Determination of rated power of the transformer in control applications

For the correct sizing of a control transformer we must consider the continuous power as well as the inrush power due to the high momentary inrush current caused when electromechanical devices such as contactors or relays are energized.

During the normal operation of control circuit the transformer must supply a high instantaneous power for a short time.

From the thermal point of view this is not a problem due to the very short time, however, this situation could be problematic due to the reduction of output voltage in the transformer.

If the secondary voltage decreases in excess, some devices might not operate and the control circuit won't work properly.

Thus, in every control circuit we will take into account several facts:

- The maximum power in a given moment (inrush power)
- Continuous power requirement
- Power factor
- Minimum admissible voltage

Example

This example assumes the following:

- **4 contactors for motor**
sealed power: 8 VA
- **2 contactors for motor**
sealed power: 18 VA
- **1 contactors for motor**
sealed power: 22 VA
Inrush power: 280 VA
- **3 signalling lamps of 2 VA**

An exhaustive study in each situation could be very complex due to the particularities on every application, however there are simple rules to determine the correct size of a transformer.

We can suppose that the power factor is $\cos \phi = 0,5$ during the operation of contactors.

The instantaneous power will be:

$$P_{inst} = \Sigma P_m + \Sigma P_s + P_a$$

$\Sigma P_m \rightarrow$ sum of the sealed power of the contactors

$\Sigma P_s \rightarrow$ sum of the power of the signalling lamps

$P_a \rightarrow$ Inrush power of the biggest contactor

With the continuous power requirement and the instantaneous power required by the circuit, we are able to choose the adequate size of transformer (see the [maximum instantaneous power of TR21 transformers](#)).

The total sealed power will be:

$$\begin{aligned} 4 \times 8 \text{ VA} &= 32 \text{ VA} \\ 2 \times 18 \text{ VA} &= 36 \text{ VA} \\ 1 \times 22 \text{ VA} &= 22 \text{ VA} \\ \Sigma P_m &= \mathbf{90 \text{ VA}} \end{aligned}$$

Sum of the signalling lamps power:

$$\Sigma P_s = 3 \times 2 \text{ VA} = \mathbf{6 \text{ VA}}$$

Inrush Power of the biggest contactor:

$$P_a = \mathbf{280 \text{ VA}}$$

The instantaneous power will be:

$$P_{inst} = 90 \text{ VA} + 6 \text{ VA} + 280 \text{ VA} = \mathbf{376 \text{ VA}}$$

Continuous power:

$$P = 90 \text{ VA} + 6 \text{ VA} = \mathbf{96 \text{ VA}}$$

With this information we can select the adequate size of transformer. In this example the **rated power will be 160 VA** (the 100 VA transformer does not have enough instantaneous power).



HEAD OFFICE AND FACTORY

SILICI, 67-69
08940 CORNELLA DE LLOBREGAT
BARCELONA
SPAIN
Tel. +34 93 377 85 85
Fax +34 93 377 82 82

INTERNATIONAL SALES

Tel. +34 93 475 08 64
Fax +34 93 480 07 75
export@dfelectric.es

NATIONAL SALES

Tel. 93 475 08 64
Fax 93 480 07 76
comercial@dfelectric.es

dfelectric.es



The data reflected in this technical record are subject to the correct installation of the product in accordance with manufacturer's instructions, relevant installation standards and professional practices, maintained and used in applications for which they were made.

DF ELECTRIC retains the right to change the dimensions, specifications, materials or design of its products at any time with or without notice.

©2021 DF Electric. All rights reserved



PROTECTING THE WORLD



X-ON Electronics

Largest Supplier of Electrical and Electronic Components

Click to view similar products for [Power Transformers](#) category:

Click to view products by [DF Electric](#) manufacturer:

Other Similar products are found below :

[F-181U](#) [F-204U](#) [F-206U](#) [F-227X](#) [F-23U](#) [F-264U](#) [F-267U](#) [F-35U](#) [F-412X](#) [F-55X-1](#) [F-68U](#) [F-71U](#) [F-72Z](#) [F-74U](#) [F-83A](#) [F-84AC](#) [F-85U](#) [F-86U](#) [F-9U](#) [PCT-02](#) [PCT-03](#) [PCT6630](#) [PF2.5-20](#) [PPC-46](#) [PPC-58](#) [PSD4-36](#) [GSD-150](#) [11E009H](#) [11E012H](#) [DSW-2120](#) [DSW-228](#) [DSW-310](#) [DSW-3120](#) [DSW-356](#) [DSW-412](#) [DSW-4120](#) [DSW-424](#) [DSW-448](#) [DSW-456](#) [DSW-556](#) [DSW-610](#) [DSW-6120](#) [DSW-624](#) [DSWC-712](#) [EN216B](#) [N-39X](#) [N-49X](#) [N-4MG-1](#) [N-7A](#) [20-22-150](#)