



TR28 5.2

CONTROL SAFETY ISOLATING

single-phase transformers

TR28
5.2

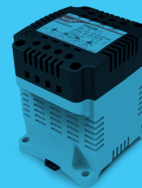

TR28
2.2



TR28
5.2

**PROTECTING
THE WORLD**





TR28
5.2

POWER

25VA...1000VA

PRI VOLTAGE

0-230-400-460V

SEC VOLTAGE

12-24V
24-48V
115-230V

STANDARDS

IEC/EN 61558-1
IEC/EN 61558-2-2
IEC/EN 61558-2-4
IEC/EN 61558-2-6



25VA
⋮
250VA



400VA
500VA



630VA
800VA
1000VA

TR28 5.2 CONTROL SAFETY ISOLATING Single-phase transformers

TR28 5.2 type transformers are intended for use as control or signalling transformer as well as general use transformer with a IP20 protection index. Protected against solid objects greater than 12,5mm as, for example, a finger due to the IP20 protection index.

The range comprises rated power between 25VA to 1000VA.

They have been designed with low impedance windings for excellent voltage regulation. They accommodate the high momentary inrush current caused when electromechanical devices are energized

They are sized for continuous service at 100% of power in an ambient temperature up to 40°C. For ambient temperatures above 40°C it is necessary to apply a derating.

Great versatility due to the dual primary voltage and the secondary windings with serial-parallel connection.

Primary voltage 230-400-460 ±15V according standard values in IEC60038. These transformers can withstand an input overvoltage of up to 10%.

Secondary windings comprise two identical windings intended to serial or parallel connection, thus the user can obtain full power in any selected voltage. The possibilities are: 12-24V, 24-48V or 115-230V.



The TR28 transformers are delivered with parallel connection (lower voltage).

Rail fixing in rated power up to 320VA.



Range



POWER (VA)		INSTANT. POWER (VA)	REFERENCE		
t_a 40°C	t_a 25°C		12 - 24V 	24 - 48V 	115 - 230V 
25	40	75	680025010	680025011	680025012
40	63	120	680040010	680040011	680040012
63	100	150	680063010	680063011	680063012
100	130	230	680100010	680100011	680100012
160	200	350	680160010	680160011	680160012
200	250	450	680200010	680200011	680200012
250	320	600	680250010	680250011	680250012
320	400	800	680320010	680320011	680320012



400	500	950	680400010	680400011	680400012
500	630	1275	680500010	680500011	680500012



630	800	1700	680630010	680630011	680630012
800	1000	2100	680800010	680800011	680800012
1000	1250	3300	681000010	681000011	681000012

OTHER CHARACTERISTICS ON REQUEST SUBJECT TO AVAILABILITY AND POSSIBILITY

t_a maximum ambient temperature



Technical data

SEC 12-24V
Control and safety transformer



Use

SEC 24-48V | 115-230V
Control and isolating transformer



Rated primary voltage	0-230-400-460V ±15V
Rated secondary voltage	12-24V 24-48V 115-230V
Rated power range	25VA ... 1000VA
Protection against electric shock	Class I
Thermal class	B (130°C)
Rated ambient temperature	40°C
Protection index	IP20
Frequency	50/60Hz
Dielectric strength between primary and secondary	≥4,5kV
Dielectric strength between windings and metallic parts	≥2,5kV
Ambient temperature of service *	-20°C ... 70°C
Storage temperature	-40°C ... 85°C

* For ambient temperatures higher than 40°C it is necessary to apply a derating.

Standards

IEC/EN 61558-1 Transformers, general specifications
IEC/EN 61558-2-2 Control transformers
IEC/EN 61558-2-4 Isolating transformers
IEC/EN 61558-2-6 Safety transformers
RoHS Compliant



Dimensions

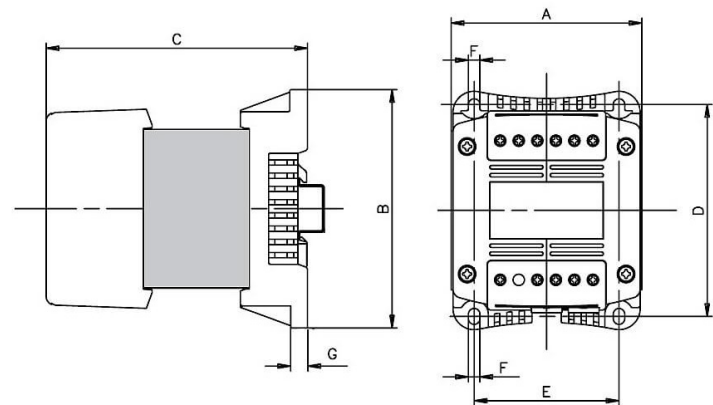

Constructive characteristics

Two identical secondary winding intended for serial or parallel connection (jumpers supplied with the transformer)

Windings in F(155°C) or H(180°C) thermal class

Flexible insulation Class B(130°C)

Impregnation Class B(130°C)

Great capacity clamp type terminal blocks:

up to 320VA → 10mm² (max. torque 2Nm)

up to 1000VA → 25mm² (max. torque 2,5Nm)

Screw earth connection (standard IEC/EN61558 prescribes in the clause 24 that it should not be possible to loosen the protection wire without the aid of a tool)

TIG welded magnetic core prevent vibration and allows small air gap to reduce the magnetization current

Fixing on symmetric rail in rated power up to 320VA

POWER (VA)	DIMENSIONS (mm)							WEIGHT (kg)
	A	B	C	D	E	F	G	
25	84	113	96	101	66	5	7,5	1,17
40	84	113	105	101	66	5	7,5	1,48
63	84	113	112	101	66	5	7,5	1,83
100	84	113	116	101	66	5	7,5	2,00
160	84	113	131	101	66	5	7,5	2,65
200	108	135	133	120	82	6,5	9,5	4,20
250	108	135	138	120	82	6,5	9,5	4,45
320	108	135	148	120	82	6,5	9,5	5,00
400	120	152	141	135	94	7	9,5	5,86
500	120	152	156	135	94	7	9,5	7,08
630	150	177	140	160	115	7	2	8,68
800	150	177	160	160	115	7	2	11,5
1000	150	177	182,6	160	115	7	2	14,4



Secondary connection

* TRANSFORMER 0-230-400-460V // 24-48V 100VA
REF 610100011

SERIAL CONNECTION

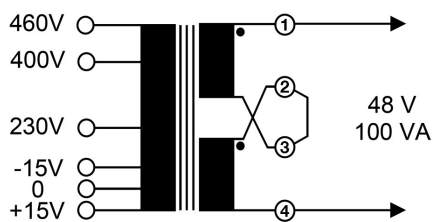

PARALLEL CONNECTION

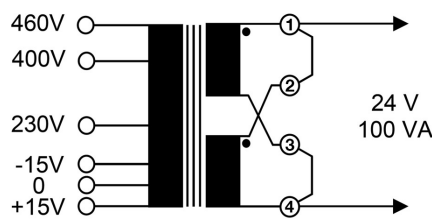

WITH MIDDLE TAP

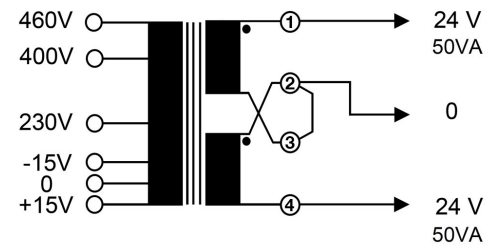

Typical values

RATED POWER t_a 40°C (VA)	INSTANTANEOUS POWER ¹ (VA)	NO-LOAD CURRENT I_o (% I_n)	NO-LOAD LOSSES P_{FE} (W)	TOTAL LOSSES $P_{Cu} + P_{FE}$ (W)	U_{cc} (%)	EFFICIENCY (%)	VOLTAGE DROP (%)
25	75	83,46	2,39	4,58	8	78,75	8,75
40	120	78,29	3,81	6,15	5,5	73,50	6,21
63	150	56,16	4,54	8,60	6,1	80,52	5,84
100	230	36,40	5,51	13,27	7,2	85,49	7,39
160	350	28,72	7,52	18,47	5,8	87,63	6,35
200	450	33,50	7,81	18,61	5,3	88,29	5,06
250	600	20,63	8,05	22,92	5,8	90,56	4,60
320	800	19,10	9,14	26,52	5,2	91,64	6,08
400	950	21,07	11,94	33,07	5,2	91,38	3,72
500	1275	19,54	14,57	34,48	4	92,95	3,35
630	1700	17,55	17,05	40,69	3,9	92,43	4,27
800	2100	16,55	23,53	51,10	3,5	92,95	3,89
1000	3300	15,08	28,76	58,76	3,1	93,88	2,21

¹ Maximum output delivered at a different values of power factor $\cos \phi = 0,5$
for a short time and for a output voltage of at least $0,95 \cdot U_n$



Transformer protection

The transformers (and their lines) must be protected against overloads and/or short-circuits that they can be submitted in use, and could cause dangerous situations for persons, animals or installations.

Due to the high inrush current (about $25I_n$) it is very difficult to get an optimal protection in the primary side. If we select the rated current of fuses according to the rated current of transformer, the inrush current will melt the fuses. In the other hand, if the fuses are overrating for withstand the inrush, the transformer won't have a good protection against overloads. For this reason we recommend to protect these transformers on the secondary side (output).

The rated current for the fuses are indicated below.

For rated currents up to and including 6,3A we can use 5x20 or 6x32 fuses according to IEC/EN60127. The characteristics (fast, slow, etc.) it depends of the load.

For rated currents above 6,3A the adequate type of fuse links are those according to IEC/EN60269-2-1 (class gG).

Rated current of fuse links

PROTECTION ON SECONDARY SIDE

POWER (VA)	OUTPUT VOLTAGE				
	12V	24V	48V	115V	230V
25	2 A	1A	500mA	200mA	100mA
40	3,15 A	1,6A	800mA	315mA	160mA
63	5A	2,5A	1,25A	500mA	250mA
100	8A	4A	2A	800mA	400mA
160	12A	6,3A	3,15A	1,25A	630mA
200	16A	8A	4A	1,6A	800mA
250	20A	10A	5A	2A	1A
320	25A	12A	6,3A	2,5A	1,25A
400	32A	16A	8A	3,15A	1,6A
500	40A	20A	10A	4A	2A
630	50A	25A	12A	5A	2,5A
800	63A	32A	16A	6,3A	3,15A
1000	80A	40A	20A	8A	4A



Derating for high ambient temperatures

If the transformer works in ambient temperature higher than 40°C, it is necessary to apply a derating for adapting transformer power to the ambient where it works, in order to avoid an excess heating that decrease life of transformer.

The following table shows the maximum power recommended for different ambient temperatures.

Maximum power of use for $t_a > 40^\circ\text{C}$

RATED POWER $t_a 40^\circ\text{C}$ (VA)	AMBIENT TEMPERATURE (°C)									
	25°C	40°C	45°C	50°C	55°C	60°C	65°C	70°C	75°C	80°C
25	35	25	23	21	19	17	15	13	12	10
40	50	40	37	34	31	28	25	21	18	15
63	100	63	58	53	48	44	39	34	29	24
100	130	100	92	85	77	69	61	54	46	38
160	200	160	148	135	123	111	98	86	74	61
200	250	200	185	169	154	138	123	107	92	77
250	320	250	231	211	192	173	154	134	115	96
320	400	320	295	271	246	221	197	172	147	123
400	500	400	369	338	307	277	246	215	184	153
500	630	500	461	423	384	346	307	269	230	191
630	800	630	581	533	484	436	387	338	290	241
800	1000	800	738	677	615	553	491	430	368	306
1000	1250	1000	923	846	769	691	614	537	460	383



Selection guide

Determination of rated power of the transformer in control applications

For the correct sizing of a control transformer we must consider the continuous power as well as the inrush power due to the high momentary inrush current caused when electromechanical devices such as contactors or relays are energized.

During the normal operation of control circuit the transformer must supply a high instantaneous power for a short time.

From the thermal point of view this is not a problem due to the very short time, however, this situation could be problematic due to the reduction of output voltage in the transformer.

If the secondary voltage decreases in excess, some devices might not operate and the control circuit won't work properly.

Thus, in every control circuit we will take into account several facts:

- The maximum power in a given moment (inrush power)
- Continuous power requirement
- Power factor
- Minimum admissible voltage

Example

This example assumes the following:

- **4 contactors for motor**
sealed power: 8 VA
- **2 contactors for motor**
sealed power: 18 VA
- **1 contactors for motor**
sealed power: 22 VA
Inrush power: 250 VA
- **3 signalling lamps of 2 VA**

An exhaustive study in each situation could be very complex due to the particularities on every application, however there are simple rules to determine the correct size of a transformer.

We can suppose that the power factor is $\cos \phi = 0,5$ during the operation of contactors.

The instantaneous power will be:

$$P_{inst} = \Sigma P_m + \Sigma P_s + P_a$$

$\Sigma P_m \rightarrow$ sum of the sealed power of the contactors

$\Sigma P_s \rightarrow$ sum of the power of the signalling lamps

$P_a \rightarrow$ Inrush power of the biggest contactor

With the continuous power requirement and the instantaneous power required by the circuit, we are able to choose the adequate size of transformer (see the [maximum instantaneous power of TR28 transformers](#)).

The total sealed power will be:

$$\begin{aligned} 4 \times 8 \text{ VA} &= 32 \text{ VA} \\ 2 \times 18 \text{ VA} &= 36 \text{ VA} \\ 1 \times 22 \text{ VA} &= 22 \text{ VA} \\ \Sigma P_m &= \mathbf{90 \text{ VA}} \end{aligned}$$

Sum of the signalling lamps power:

$$\Sigma P_s = 3 \times 2 \text{ VA} = \mathbf{6 \text{ VA}}$$

Inrush Power of the biggest contactor:

$$P_a = \mathbf{250 \text{ VA}}$$

The instantaneous power will be:

$$P_{inst} = 90 \text{ VA} + 6 \text{ VA} + 250 \text{ VA} = \mathbf{346 \text{ VA}}$$

Continuous power:

$$P = 90 \text{ VA} + 6 \text{ VA} = \mathbf{96 \text{ VA}}$$

With this information we can select the adequate size of transformer. In this example the **rated power will be 160 VA** (the 100 VA transformer does not have enough instantaneous power).



HEAD OFFICE AND FACTORY

SILICI, 67-69
08940 CORNELLA DE LLOBREGAT
BARCELONA
SPAIN
Tel. +34 93 377 85 85
Fax +34 93 377 82 82

INTERNATIONAL SALES

Tel. +34 93 475 08 64
Fax +34 93 480 07 75
export@dfelectric.es

NATIONAL SALES

Tel. 93 475 08 64
Fax 93 480 07 76
comercial@dfelectric.es

dfelectric.es



The data reflected in this technical record are subject to the correct installation of the product in accordance with manufacturer's instructions, relevant installation standards and professional practices, maintained and used in applications for which they were made.

DF ELECTRIC retains the right to change the dimensions, specifications, materials or design of its products at any time with or without notice.

©2021 DF Electric. All rights reserved



PROTECTING THE WORLD



X-ON Electronics

Largest Supplier of Electrical and Electronic Components

Click to view similar products for [Current Transformers](#) category:

Click to view products by [DF Electric](#) manufacturer:

Other Similar products are found below :

[L595100](#) [ACST-260](#) [MP3500](#) [L595050](#) [BV UI 303 0143](#) [45077](#) [MCR-SL-CUC-200-I](#) [PACT RCP-4000A-UIRO-PT-D14](#) [PACT RCP-4000A-UIRO-PT-D19](#) [E54CT1L](#) [CTD-KIT](#) [44021](#) [44027](#) [44104](#) [45023](#) [45078](#) [PA3828NL](#) [2CSM029000R1211](#) [HCT204KFH](#) [HCT20K-QD](#) [HCT-1\(80\)AH](#) [MCR-SL-CUC-600-I](#) [749196500](#) [CST206-1A-B](#) [PVS100/230/110V](#) [PVS250/230/110V](#) [PVS250/230/230V](#) [PVS301/230/12V](#) [PVS50/A230/24V](#) [PVS630/230/24V](#) [7251](#) [CST-1025](#) [AS-100](#) [AS-101](#) [AS-105](#) [AS-112](#) [AS-404](#) [TEZ0.5/D230/10.5-10.5V](#) [TEZ0.5/D230/6V](#) [TEZ0.5/D230/9V](#) [TEZ10/D230/12V](#) [TEZ10/D230/15-15V](#) [TEZ10/D230/18V](#) [TEZ10/D230/6V](#) [TEZ10/D230/7.5V](#) [TEZ10/D230/9V](#) [TEZ10/D400/12V](#) [TEZ10/D400/24V](#) [TEZ1.5/D230/10.5-10.5V](#) [TEZ1.5/D230/10.5V](#)