

Datasheet
10 I/Os Relay Module
CPU Arduino NANO

Technical Features CONECTABLE PLC ARDUINO 24Vdc 10 I/Os
Pinout

| | |
|----------------------------|--|
| MODEL TYPE | PLC 10 I/Os Digital Module CPU Arduino Nano |
| Input Voltage | 12 to 24Vdc (Fuse protection (2.5A) Polarity protection) |
| Input rated voltage | 24Vdc |
| Rated Power | 30 W |
| I max. | 15A |
| Size | 100x45x115 |
| Clock Speed | 16MHz |
| Flash Memory | 32KB of which 4KB used by bootloader |
| SRAM | 2KB |
| EEPROM | 1KB |
| Communications | USB, RS485, Ethernet |
| USB consideration! | Only for uploading or debugging, NOT connected as a serial Cannot be working in a final application |

General Features

| | | |
|--|---|-----------------|
| Power supply voltage | DC power supply | 12 to 24Vdc |
| Operating voltage range | DC power supply | 11.4 to 25.4Vdc |
| Power consumption | DC power supply | 30 W MAX |
| External power supply | Power supply voltage | 24Vdc |
| | Power supply out. cap. | 300mA |
| Insulation resistance | 20MΩ min.at 500Vdc between the AC terminals and the protective earth terminal. | |
| Dielectric strength | 2.300 VAC at 50/60 Hz for one minute with a leakage current of 10mA max. Between all the external AC terminals and the protective ground terminal. | |
| Shock resistance | 80m/s ² in the X, Y and Z direction 2 times each. | |
| Ambient temperature (operating) | 0° to 60°C | |
| Ambient humidity (operating) | 10% to 90% (no condensation) | |
| Ambient environment (operating) | With no corrosive gas | |
| Ambient temperature (storage) | -20° to 60°C | |
| Power supply holding time | 2ms min. | |
| Weight | 284g max. | |

A ZONE

i INPUTS (x10)

| | |
|--------------------------------------|---|
| Digital Input (24Vdc) - (x10) | 3.3 to 24 Vdc Input Impedance: 27K Separated PCB ground Rated Voltage: 10Vac |
| | 220 Vac (3 – 48 Vdc) Input Impedance: 54K Rated Voltage: 220 Vac |
| | Imin: 2 to 12 mA Opto-isolation Rated Voltage: 24 Vdc |
| | Antipolarity + Overcurrent (220 Ac) |

Expandability

ModbusRTU RS485: 32 elements - USB - Ethernet

i OUTPUTS (x10)

| | |
|--|--|
| Digital Isolated Output Relay - (x10) | 24 Vdc / 220 Vac I max: 5A Galvanic Isolation Diode protected for Relay |
|--|--|

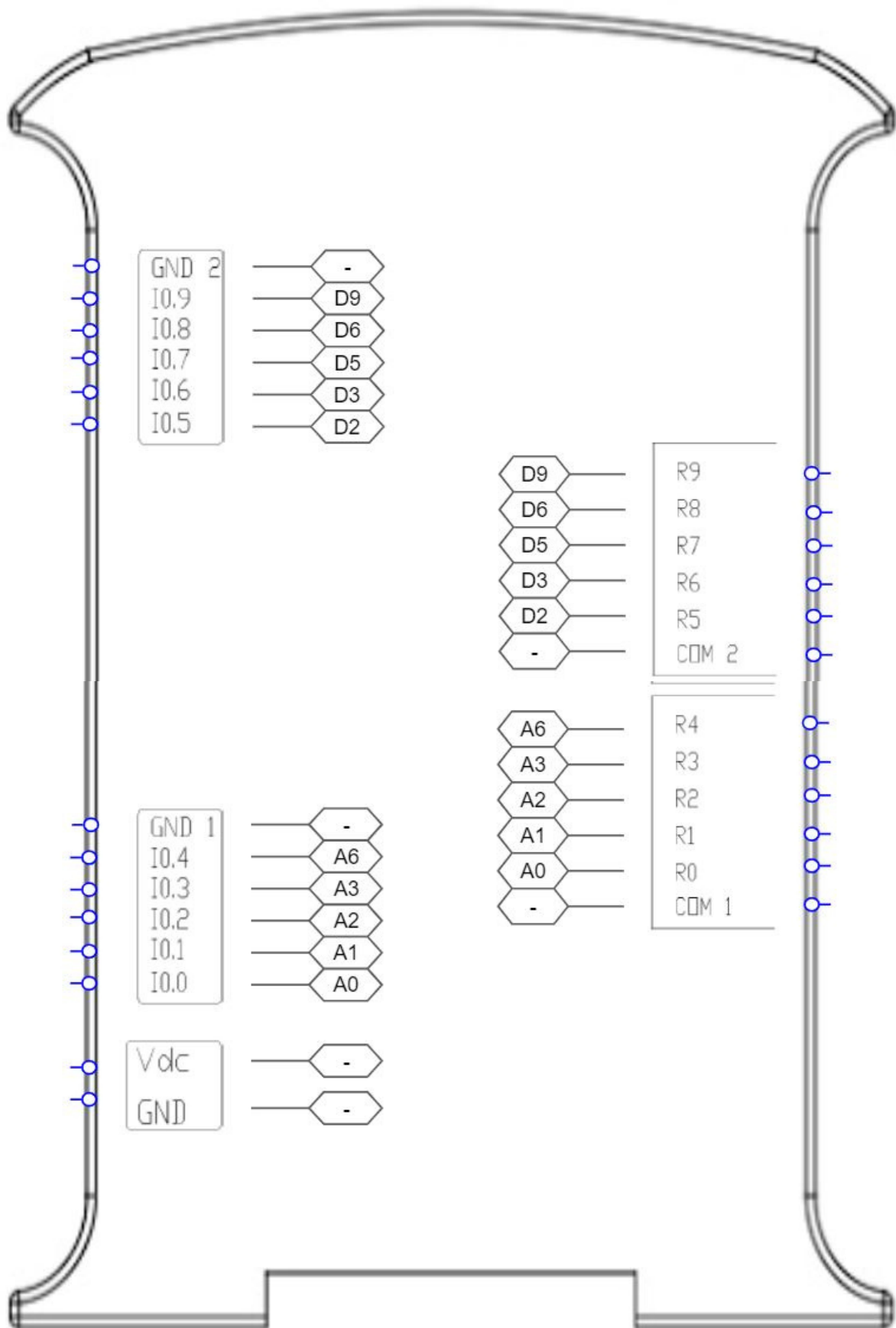

Performance Specifications

| | |
|----------------------|---|
| Arduino Board | Arduino Nano |
| Control method | Stored program method |
| I/O control method | Combination of the cyclic scan and immediate refresh processing methods. |
| Programming language | Arduino IDE. Based on wiring (Wiring is an Open Source electronics platform composed of a programming language. "similar to the C") |
| Microcontroller | ATmega4809 |
| | http://arduino.cc/en/Tutorial/HomePage |

Install Arduino IDE and the Industrial Shields boards

The steps to follow to install our equipment's to Arduino IDE are:

- Open the Arduino IDE, versión 1.8.0 or superior. If you don't have it yet, you can download here <https://www.arduino.cc/en/Main/Software>.
- Press the "Preferences" option to "File" menu and open the preferences window.
- In the text box "Additional boards manager URLs", add the direction: http://apps.industrialshields.com/main/arduino/boards/package_industrialshields_index.json
- Close the preferences window with the "OK" button.
- Click on "Tools" menu, and open the "Boards" submenu, and click the "Boards Manager" option, to open the Boards Manager window.
- Search "industrialshields" to the search filter and select to the list and click "Install"
- Close the "Boards Manager". Once it is performed that steps, you are available to select each PLC that you wish to work on "Tools" -> "Boards": M-Duino..

To get more information:

<https://www.industrialshields.com/first-steps-with-the-industrial-arduino-based-plc-s-and-the-panel-pc-s-raspberry-pi-based#boards>

Warnings



Unused pins should not be connected. Ignoring the directive may damage the controller.

Before using this product, it is the responsibility of the user to read the product's User Guide and all accompanying documentation.

Industrial Shields PLCs must be powered between 12Vdc and 24Vdc. If a higher voltage is supplied to the equipment can suffer irreversible damage.

Maintenance must be performed by qualified personnel familiarized with the construction, operation, and hazards involved with the control.

Maintenance should be performed with the control out of operation and disconnected from all sources of power.

The Industrial Shields Family PLCs are Open Type Controllers. It is required that you install the M-Duino PLC in a housing cabinet, or electric control room. Entry to the housing, cabinet, or electric control room should be limited to authorized personnel.

Inside the housing, cabinet or electric control room, the Industrial Shields PLC must be at a minimum distance from the rest of the components of a minimum of 25 cm, it can be severely damaged.









Failure to follow these installation requirements could result in severe personal injury and/or property damage. Always follow these requirements when installing M-Duino family PLCs.

In case of installation or maintenance of the M-Duino please follow the instructions marked in the Installation and Maintenance section on the User Guide.

Do not disconnect equipment when a flammable or combustible atmosphere is present.

Disconnection of equipment when a flammable or combustible atmosphere is present may cause a fire or explosion which could result in death, serious injury and/or property damage.

Symbology

| | |
|---|--|
|  | Indicates that the equipment is suitable for direct current only, to identify relevant terminals |
|  | Indicates that the equipment is suitable for alternating current only, to identify relevant terminals |
|  | To identify the control by which a pulse is started. |
|  | To identify an earth (ground) terminal in cases where neither the symbol 5018 nor 5019 is explicitly required. |
|  | To identify the switch by means of which the signal lamp(s) is (are) switched on or off. |
|  | CE marking indicates that a product complies with applicable European Union regulations |
|  | Indicates a potentially hazardous situation which, if not avoided, could result in death or serious injury |
|  | To indicate hazards arising from dangerous voltages |

X-ON Electronics

Largest Supplier of Electrical and Electronic Components

Click to view similar products for [I/O Modules](#) category:

Click to view products by [DF Robot](#) manufacturer:

Other Similar products are found below :

[70L-OAC-L](#) [G21960000700](#) [G34960002700](#) [G88104401](#) [IDC-5B](#) [OACU](#) [C4SWOUT](#) [FC6A-T32K3](#) [SNAP-OAC5MA](#) [FC6A-N16B3](#)
[FC6A-N32B3](#) [FC6A-T16P3](#) [G3TAOD201SDC24](#) [PB32HQ](#) [PB16T](#) [PB8](#) [PB8H](#) [C200H-OD211](#) [GT1-AD04CST](#) [GT1-DA04](#) [70GRCQ24-](#)
[HS](#) [M-OAC5](#) [G4OAC24AMA](#) [2736505](#) [6202](#) [6402](#) [IL MOD BK DI8 DO4-PAC](#) [FC6A-J2C1](#) [FC6A-KC1C](#) [FC6A-N08A11](#) [FC6A-M24BR1](#)
[FC6A-K4A1](#) [FC6A-T32P3](#) [9-1393028-2](#) [GP32900003700](#) [641-480-5022](#) [PB16H](#) [WISE-4050/LAN-B](#) [WISE-S614T-A](#) [ADAM-4068-C](#)
[56475](#) [ADAM-4017+-F](#) [ADAM-4118-C](#) [AMAX-4856-B](#) [WISE-4050-B](#) [ADAM-4051-C](#) [ADAM-4053-F](#) [GT1-AD08MX](#) [TM5SDO6TBFS](#)
[70Q3446](#)