

MG811 CO2 Sensor

Features

- Good sensitivity and selectivity to CO2
- Low humidity and temperature dependency
- Long stability and reproducibility

Application

- Air Quality Control
- Ferment Process Control
- Room Temperature CO2 concentration Detection

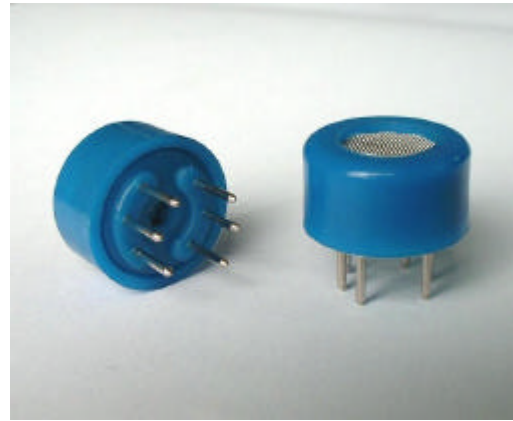

Structure and Testing Circuit

Sensor Structure and Testing Circuit as Figure, It composed by solid electrolyte layer (1), Gold electrodes(2), Platinum Lead (3), Heater (4), Porcelain Tube (5), 100m double-layer stainless net(6), Nickel and copper plated ring(7), Bakelite(8), Nickel and copper plated pin (9).

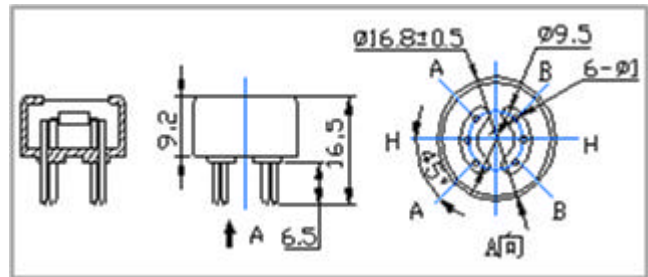
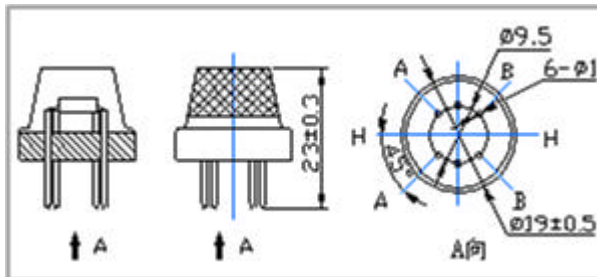
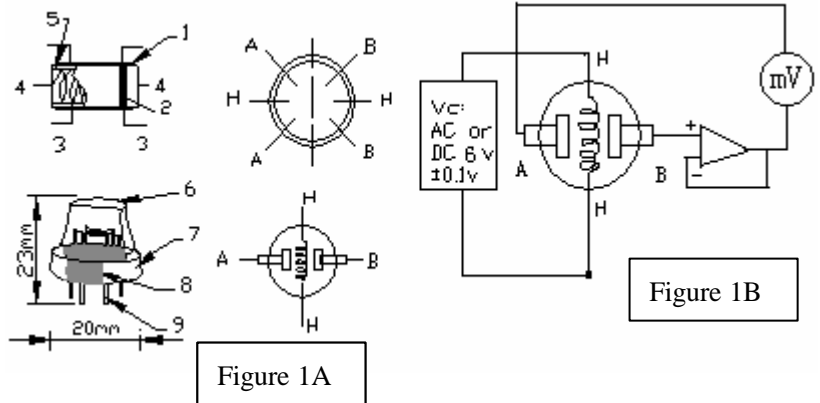

Working Principle

Sensor adopt solid electrolyte cell Principle , It is composed by the following solid cells :

Air , Au|NASICON|| carbonate|Au, air , CO2

When the sensor exposed to CO2 , the following electrodes reaction occurs :

Cathodic reaction : $2Li + + CO_2 + 1/2O_2 + 2e^- = Li_2CO_3$

Anodic reaction : $2Na + + 1/2O_2 + 2e^- = Na_2O$

Overall chemical reaction : $Li_2CO_3 + 2Na + = Na_2O + 2Li + + CO_2$

The Electromotive force (EMF) result from the above electrode reaction, accord with according to Nernst's equation :

$$EMF = E_c - (R \times T) / (2F) \ln (P(CO_2))$$

P(CO₂)—CO₂--- partial Pressure E_c—Constant Volume R—Gas Constant volume

T— Absolute Temperature (K) F—Faraday constant

From Figure 1B , Sensor Heating voltage supplied from other circuit , When its surface temperature is high enough , the sensor equals to a cell, its two sides would output voltage signal ,and its result accord with Nernst ' s equation. In sensor testing, the impedance of amplifier should be within 100—1000G , Its testing current should be control below 1pA.

Specifications :

Symbol	Parameter Name	Technical	Remarks
V_H	Heating Voltage	6.0 ± 0.1 V	AC or DC
R_H	Heating Resistor	$30.0 \pm 5\%$	Room Temperature
I_H	Heating Current	@200mA	
P_H	Heating Power	@1200mW	
Tao	Operating Temperature	-20—50	
Tas	Storage Temperature	-20—70	
E_{MF}	Output	30—50mV	350—10000ppmCO2

Sensitivity :

Figure 2 Shows gas sensor sensitivity curve. :

Conditions:

Tem : 28 °C

RH : 65%

Oxygen : 21%

EMF: sensor EMF under different gas and concentration .

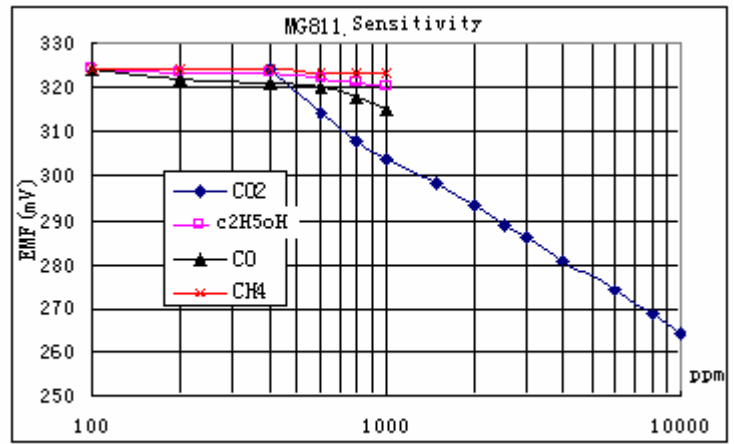

Response and Resume Characteristic :

Figure 3 shows Solid electrolyte sensor response and resume characteristics.

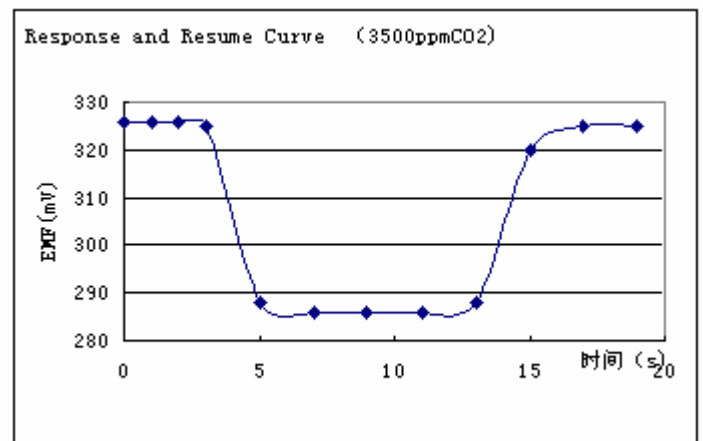

Temperature and Humidity Dependency :

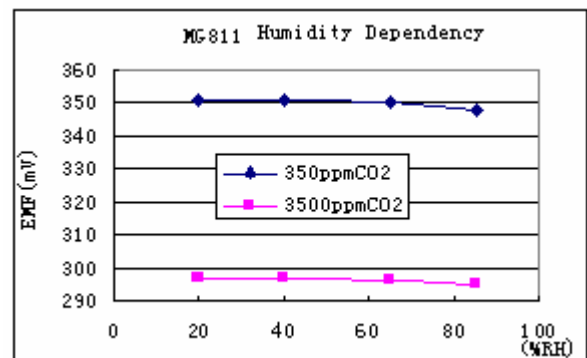
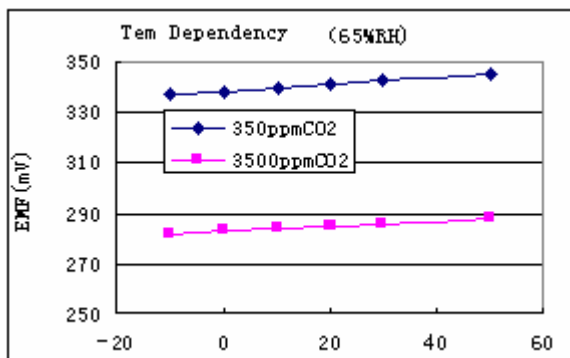

X-ON Electronics

Largest Supplier of Electrical and Electronic Components

Click to view similar products for [Multiple Function Sensor Development Tools](#) category:

Click to view products by [DF Robot](#) manufacturer:

Other Similar products are found below :

[MAXWSNENV#](#) [STEVAL-MKIT01V1](#) [KT-O2-25%-TB200A-E](#) [KT-TVOC-200-TB200A](#) [KT-NmHc-200-TB200A](#) [SEN0344](#) [PIM520](#)
[PIM518](#) [PIM519](#) [PIM502](#) [AS7022-EVALKIT](#) [ALTEHTG2SMIP](#) [MAX30101WING#](#) [OB1203SD-U-EVK](#) [MIKROE-4265](#) [A000070](#)
[EV_ICG-20660L](#) [GX-F12A-P](#) [GX-F15A](#) [GX-F8AI-P](#) [GX-H15AI-P](#) [GX-H6A-P](#) [GX-HL15B-P](#) [1093](#) [MIKROE-2455](#) [MIKROE-2458](#)
[MIKROE-2507](#) [MIKROE-2508](#) [MIKROE-2516](#) [MIKROE-2529](#) [1458](#) [MIKROE-1628](#) [176](#) [189](#) [1893](#) [2106](#) [ATQT4-XPRO](#) [GP30-DEMO](#)
[MODULE](#) [GX-F12AI-P](#) [GX-F15A-P](#) [GX-FL15B-P](#) [GX-H12AI-P](#) [GX-H15A-P](#) [GX-H6AI-P](#) [GX-H8A-P](#) [GX-F15AI-P](#) [GX-FL15A-P](#) [AAS-](#)
[AQS-UNO](#) [DFR0018](#) [DFR0131](#)