

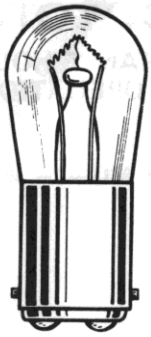

Large Incandescent Indicators

FOR MOUNTING IN 1" CLEARANCE HOLE
FOR 24 TO 250V OPERATION



S-6
DOUBLE CONTACT
BAYONET BASE

See lamp ratings
on page K.

Recognized under the component
program of Underwriters'
Laboratories Inc.
75W., 125V.

These series indicator lights meet or exceed requirements of MIL-L-3661.
For materials and finishes of products in this group, see page 29D.

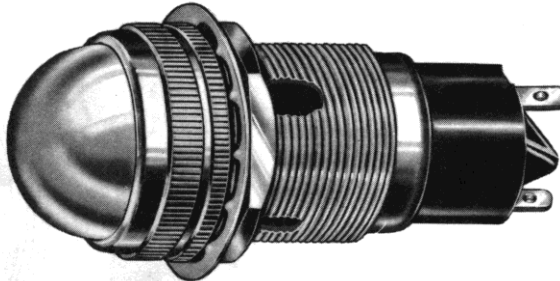

80-3402-1211-301
Dome lens

WITH SCREW-ON LENS CAPS

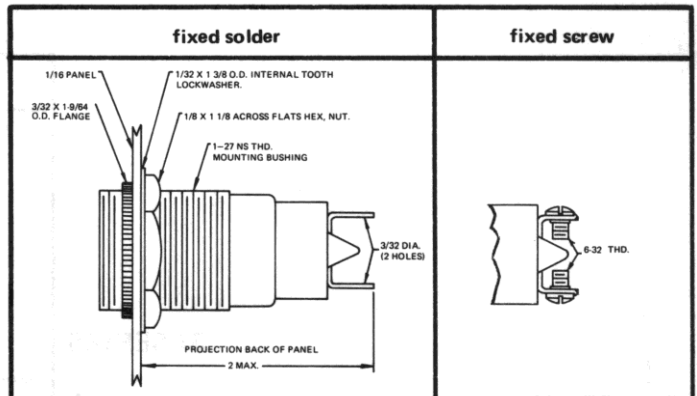

80 SERIES

BASE PART NUMBERS

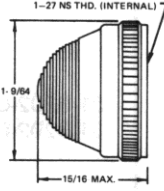
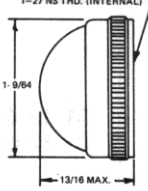
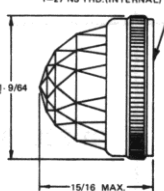
CAP PART NUMBERS		COMPLETE ASSEMBLY PART NUMBERS	
 <p>TORPEDO 80-0511-300 back frosted 80-0531-300 unfrosted</p>		80-3402-05-301	80-3202-05-301
	 <p>DOME 80-1211-300 back frosted 80-1231-300 unfrosted</p>		80-3402-1211-301 80-3402-1231-301
 <p>TORPEDO FACETED 80-1331-300 unfrosted</p>		80-3402-1331-301	80-3202-1331-301

Part numbers shown in gray are normally
in inventory at your Dialight Distributor.

Part numbers listed in this catalog designate products with RED lens.
For ordering lens colors other than red, consult chart on page 2D.

X-ON Electronics

Largest Supplier of Electrical and Electronic Components

Click to view similar products for [Lamp Lenses](#) category:

Click to view products by [Dialight](#) manufacturer:

Other Similar products are found below :

[812-0974](#) [140-1475-003](#) [151-2900-200](#) [199-5261](#) [221-1131-203](#) [222-0113-303](#) [222-0135-203](#) [270-0121](#) [221-1132-203](#) [222-0135-303](#)
[22872.9](#) [39-02-4A](#) [39-02-6A](#) [39-08-3A](#) [39-08-4A](#) [39-12-1A](#) [D38999/20ZA98SA](#) [359-8430-0932-502-327](#) [39-02-3A](#) [39-12-2A](#) [39-12-7B](#)
[402-0172-100](#) [402-0175-100](#) [053-0992](#) [053-0993](#) [053-0994](#) [091-0931](#) [091-0971](#) [091-0932](#) [101-0974](#) [103-1233-403](#) [533-0001](#) [533-0601](#)
[534-0701-537](#) [270-0212](#) [359-8430-0932-502](#) [0190535300](#) [0510113303](#) [39-06-2A](#) [199-5263](#) [241-0001-804](#) [830-1432-003](#) [39-08-7A](#) [271-0171](#) [047-2900-400](#) [39-04-4B](#) [1813/8](#) [R14-13](#) [BF2.4/RC](#) [128-0931-003](#) [FCP-M1-XPE1-HRF](#)