

183 SERIES INDICATOR LIGHTS

Caps Ordered Separately, See Below

PART NO.	CAP	FIG
183-9730-14-602	ALL	1
183-9830-14-604	ALL	2

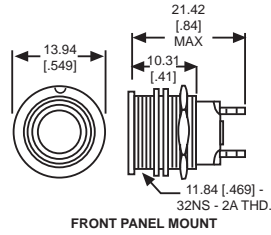

Fig. 1

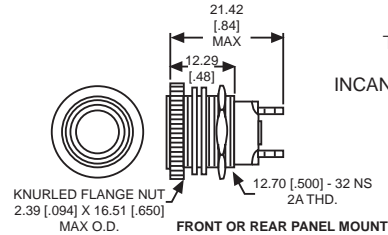

Fig. 2

Uses:
T-1 3/4 MIDGET
FLANGE BASE
INCANDESCENT LAMP

184, 186, 187, 188, 302, 304, 305 & 307 SERIES CAPS

1/2" SQUARE

CAP PART NO.	COLOR	FIG
184-1871	RED	3
184-1872	GREEN	3
184-1873	YELLOW	3
184-1875	WHITE	3

1/2" ROUND

CAP PART NO.	COLOR	FIG
186-1471	RED	7
186-1472	GREEN	7
186-1473	YELLOW	7
186-1475	WHITE	7

5/8" SQUARE†

CAP PART NO.	COLOR	FIG
304-1871	RED	4
304-1872	GREEN	4
304-1873	YELLOW	4
304-1875	WHITE	4

5/8" ROUND†

CAP PART NO.	COLOR	FIG
305-1471	RED	8
305-1472	GREEN	8
305-1473	YELLOW	8
305-1475	WHITE	8

3/4" SQUARE

CAP PART NO.	COLOR	FIG
187-1871	RED	5
187-1872	GREEN	5
187-1873	YELLOW	5
187-1875	WHITE	5

3/4" ROUND

CAP PART NO.	COLOR	FIG
188-1471	RED	9
188-1472	GREEN	9
188-1473	YELLOW	9
188-1475	WHITE	9

3/4" SQUARE†

CAP PART NO.	COLOR	FIG
307-1871	RED	6
307-1872	GREEN	6
307-1873	YELLOW	6
307-1875	WHITE	6

3/4" x 1" RECTANGULAR†

CAP PART NO.	COLOR	FIG
302-3471	RED	10
302-3472	GREEN	10
302-3473	YELLOW	10
302-3475	WHITE	10

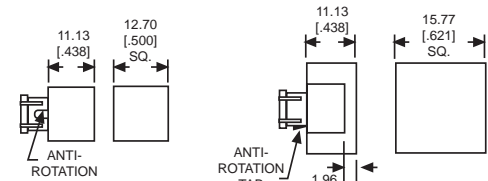

Fig. 3

Fig. 4

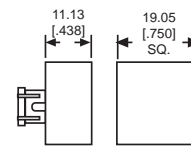

Fig. 5

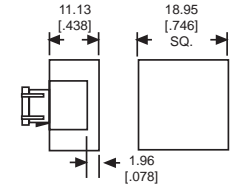

Fig. 6

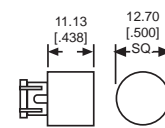

Fig. 7

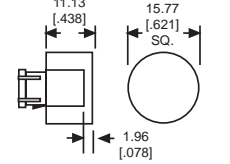

Fig. 8

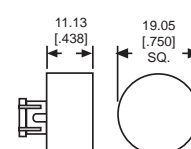

Fig. 9

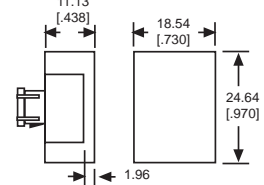

Fig. 10

Please contact factory for legend information available on Figures 3 thru 10

534 SERIES CAP KITS

3/4" x 1" LEGEND KITS†

KIT PART NO.	LENS/FILTER COLOR	FIG
534-0701-030	RED, GREEN, AMBER, BLUE/NONE	11
534-0701-037	CLEAR/NONE	11
534-0701-537	CLEAR/RED, GREEN, AMBER, BLUE	11

Legends provided by Dialight Stocking Distributors

† Feature fingertip grip for use with snap-in mount switches and indicators

Material & Finish: Base, Clear anodized aluminum;
Cap, High temperature scratch-resistant plastic

Neon and incandescent lamp information on Pages 35 and 36.

Dimensions in mm [inches]

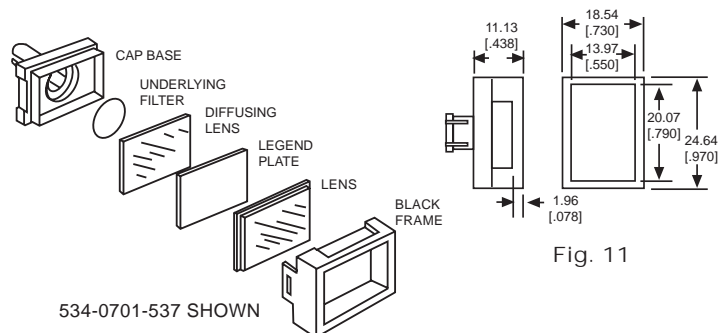

Fig. 11

534-0701-537 SHOWN

X-ON Electronics

Largest Supplier of Electrical and Electronic Components

Click to view similar products for [Lamp Holders & Accessories](#) category:

Click to view products by [Dialight](#) manufacturer:

Other Similar products are found below :

[811730-1](#) [MS25041-6-327](#) [MS25041-8-327](#) [162-8430-0931-502-327](#) [PBMBN](#) [251-7538-15-504](#) [2802](#) [294502](#) [162-8430-0932-502-327](#) [183-9730-14-602](#) [21-16](#) [251-8738-15-504](#) [259-1930-29-801](#) [2707508753800](#) [350-0410-01-203](#) [367-8430-0971-503](#) [367-8430-09-802](#) [367-8430-09-810](#) [371-8738-14-504](#) [4610](#) [367-8430-0972-503](#) [367-8430-09-808](#) [367-8430-09-809](#) [492H412-9](#) [MS25256-2-327](#) [737AS15](#) [830-1430-14-503](#) [PBMBP](#) [851-1030-0001-504](#) [047340229301](#) [061131002301](#) [081041001100](#) [019310105301](#) [080320205303](#) [361-8836-0931-552](#) [1.71.209.001/0000](#) [1.71.209.001/0000](#) [1301910073](#) [04-12](#) [02-82](#) [26-07](#) [07-20](#) [101-8430-09-203](#) [177-8430-09-503](#) [162-8430-0937-502](#) [812-1030-09-506](#) [250-8738-14-504](#) [125-1310-11-103](#) [270-1930-702](#) [MS25041-7-327](#)