

Datalamp plug-in Holders

The panel mounting Datalamp Holder is available with or without screw-on collar.





If the conditions of use demand that the plug-in Datalamp Cartridge be very securely retained, the necessary thread is left exposed in mounting and the collar is used and screwed down tight.

Note: When Datalamp Holders are used with Neon Cartridges without built in resistor, the necessary current-limiting resistor must be added externally. See the chart recommended resistance values on Page 12B.

MATERIALS AND FINISHES – Datalamp Holder

- **Mounting Bushing:** Aluminum, black anodize.
- **Collar and Flange Nut:** Aluminum. Standard finish – black anodize. Optional – clear anodize.
- **Mounting Nut:** Brass, white nickel finish.
- **Internal-tooth Lockwasher:** Phosphor bronze, white nickel finish.
- **Terminals:** Phosphor bronze, gold plated.

Illust. approx. 70% actual size.

DATALAMP HOLDER Only	Accommodate Cartridge Figure Numbers	Turret Terminals	Solder Cup Terminals	Amp "53" Taper Pin Receptacles	Solder Blade Terminals	Dim. "A" (max.)
C  	1-4, 7, 9, 11, 12	508-8738-504	508-7538-504	508-9038-504	508-7438-504	57/64"
	1-4, 7, 9, 11, 12	250-8738-14-504	250-7538-14-504	250-9038-14-504	250-7438-14-504	1-1/32"
G  	6, 8, 10	508-8745-504	508-7545-504	508-9045-504	508-7445-504	63/64"
	6, 8, 10	250-8745-14-504	250-7545-14-504	250-9045-14-504	250-7445-14-504	1-1/8"

Note: To obtain Datalamp with optional clear anodize finish, change "5" in -504 to "6". Example: 508-8738-604.

CARTRIDGE CONNECTORS and SPEED CLIP

For use in mounting Incandescent and Neon Datalamp Cartridges in 9/32" clearance hole.

Direct mounting of Datalamp Cartridges on the panel is possible using the accessories illustrated. The Datalamp is inserted through a clearance hole and is secured by sliding the speed clip over the housing from the rear. The connector is adapted for soldered wire leads and fits the Datalamp plug-in pins.

Speed clips and cartridge connectors are recommended for use with Neon or long life low powered Incandescent Datalamp cartridges. Where high powered Incandescent Datalamps are required, consideration of heat dissipation must be given.

Not providing a Datalamp holder (which acts as a heat sink) may cause shorter filament life for high powered Incandescent Datalamps unless used on an intermittent basis.

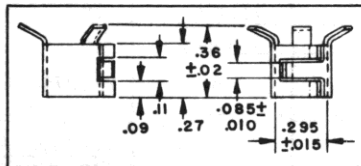

We suggest that installation be made on metal panels only.

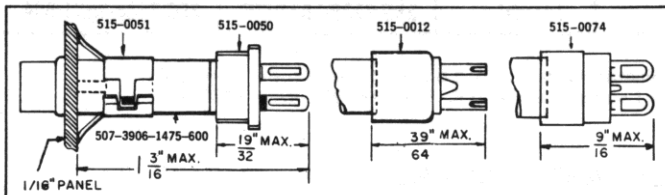

SPEED CLIP

CARTRIDGE CONNECTORS



515-0051



515-0074



515-0012



515-0050

DATALITE PROJECTIONS FRONT AND BACK OF PANEL **

Lamp-holder	Datalamp Holder				
	Datalamp Lens Shape	*With Collar		*W/O Collar	
		Front Proj.	Back Proj.	Front Proj.	Back Proj.
C	Flat	1/2"	57/64"	7/32"	1-1/32"
	Short Cylindrical	21/32"	57/64"	3/8"	1-1/32"
	Short Stovepipe	21/32"	57/64"	3/8"	1-1/32"
	Stovepipe (Standard)	7/8"	57/64"	39/64"	1-1/32"
	Long Cylindrical	7/8"	57/64"	39/64"	1-1/32"
G	Datalamp Holder				
	Datalamp Lens Shape	*With Collar		*W/O Collar	
		Front Proj.	Back Proj.	Front Proj.	Back Proj.
	Short Cylindrical	21/32"	63/64"	3/8"	1-1/8"
Stovepipe (standard)	7/8"	63/64"	39/64"	1-1/8"	
Long Cylindrical	7/8"	63/64"	39/64"	1-1/8"	

* Dimensions are average values. ** 1/16" panel thickness (ref.)

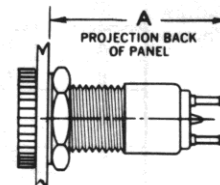
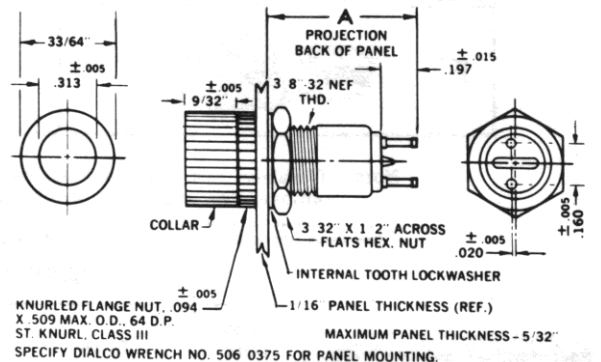

X-ON Electronics

Largest Supplier of Electrical and Electronic Components

Click to view similar products for [Lamp Holders & Accessories](#) category:

Click to view products by [Dialight](#) manufacturer:

Other Similar products are found below :

[811730-1](#) [MS25041-6-327](#) [MS25041-8-327](#) [162-8430-0931-502-327](#) [PBMBN](#) [251-7538-15-504](#) [2802](#) [294502](#) [162-8430-0932-502-327](#) [183-9730-14-602](#) [21-16](#) [251-8738-15-504](#) [259-1930-29-801](#) [2707508753800](#) [350-0410-01-203](#) [367-8430-0971-503](#) [367-8430-09-802](#) [367-8430-09-810](#) [371-8738-14-504](#) [4610](#) [367-8430-0972-503](#) [367-8430-09-808](#) [367-8430-09-809](#) [492H412-9](#) [MS25256-2-327](#) [737AS15](#) [830-1430-14-503](#) [PBMBP](#) [851-1030-0001-504](#) [047340229301](#) [061131002301](#) [081041001100](#) [019310105301](#) [080320205303](#) [361-8836-0931-552](#) [1.71.209.001/0000](#) [1.71.209.001/0000](#) [1301910073](#) [04-12](#) [02-82](#) [26-07](#) [07-20](#) [101-8430-09-203](#) [177-8430-09-503](#) [162-8430-0937-502](#) [812-1030-09-506](#) [250-8738-14-504](#) [125-1310-11-103](#) [270-1930-702](#) [MS25041-7-327](#)