

DIALIGHT PART NUMBER	LED COLOR		
	POSITION 1	POSITION 2	POSITION 3
564-0100-002F	** BLANK **	** BLANK **	GREEN DIFFUSED
564-0100-010F	** BLANK **	RED DIFFUSED	** BLANK **
564-0100-011F	** BLANK **	RED DIFFUSED	RED DIFFUSED
564-0100-020F	** BLANK **	GREEN DIFFUSED	** BLANK **
564-0100-022F	** BLANK **	GREEN DIFFUSED	GREEN DIFFUSED
564-0100-030F	** BLANK **	YELLOW DIFFUSED	** BLANK **
564-0100-100F	RED DIFFUSED	** BLANK **	** BLANK **
564-0100-101F	RED DIFFUSED	** BLANK **	RED DIFFUSED
564-0100-102F	RED DIFFUSED	**BLANK**	GREEN DIFFUSED
564-0100-111F	RED DIFFUSED	RED DIFFUSED	RED DIFFUSED
564-0100-112F	RED DIFFUSED	RED DIFFUSED	GREEN DIFFUSED
564-0100-113F	RED DIFFUSED	RED DIFFUSED	YELLOW DIFFUSED
564-0100-120F	RED DIFFUSED	GREEN DIFFUSED	** BLANK **
564-0100-121F	RED DIFFUSED	GREEN DIFFUSED	RED DIFFUSED
564-0100-122F	RED DIFFUSED	GREEN DIFFUSED	GREEN DIFFUSED
564-0100-123F	RED DIFFUSED	GREEN DIFFUSED	YELLOW DIFFUSED
564-0100-129F	RED DIFFUSED	GREEN DIFFUSED	BLUE (WHITE DIFF. LENS)
564-0100-132F	RED DIFFUSED	YELLOW DIFFUSED	GREEN DIFFUSED
564-0100-173F	RED DIFFUSED	ORANGE DIFFUSED	YELLOW DIFFUSED
564-0100-200F	GREEN DIFFUSED	** BLANK **	** BLANK **
564-0100-201F	GREEN DIFFUSED	** BLANK **	RED DIFFUSED
564-0100-202F	GREEN DIFFUSED	** BLANK **	GREEN DIFFUSED
564-0100-203F	GREEN DIFFUSED	** BLANK **	YELLOW DIFFUSED
564-0100-207F	GREEN DIFFUSED	** BLANK **	ORANGE DIFFUSED
564-0100-209F	GREEN DIFFUSED	** BLANK **	BLUE (WHITE DIFF. LENS)
564-0100-210F	GREEN DIFFUSED	RED DIFFUSED	** BLANK **
564-0100-211F	GREEN DIFFUSED	RED DIFFUSED	RED DIFFUSED
564-0100-212F	GREEN DIFFUSED	RED DIFFUSED	GREEN DIFFUSED
564-0100-213F	GREEN DIFFUSED	RED DIFFUSED	YELLOW DIFFUSED
564-0100-217F	GREEN DIFFUSED	RED DIFFUSED	ORANGE DIFFUSED
564-0100-219F	GREEN DIFFUSED	RED DIFFUSED	BLUE (WHITE DIFF. LENS)
564-0100-220F	GREEN DIFFUSED	GREEN DIFFUSED	** BLANK **
564-0100-221F	GREEN DIFFUSED	GREEN DIFFUSED	RED DIFFUSED
564-0100-222F	GREEN DIFFUSED	GREEN DIFFUSED	GREEN DIFFUSED
564-0100-223F	GREEN DIFFUSED	GREEN DIFFUSED	YELLOW DIFFUSED
564-0100-227F	GREEN DIFFUSED	GREEN DIFFUSED	ORANGE DIFFUSED
*564-0100-229F	GREEN DIFFUSED	GREEN DIFFUSED	BLUE (WHITE DIFF. LENS)
564-0100-231F	GREEN DIFFUSED	YELLOW DIFFUSED	RED DIFFUSED
564-0100-232F	GREEN DIFFUSED	YELLOW DIFFUSED	GREEN DIFFUSED
564-0100-233F	GREEN DIFFUSED	YELLOW DIFFUSED	YELLOW DIFFUSED
564-0100-271F	GREEN DIFFUSED	ORANGE DIFFUSED	RED DIFFUSED
564-0100-277F	GREEN DIFFUSED	ORANGE DIFFUSED	ORANGE DIFFUSED
564-0100-279F	GREEN DIFFUSED	ORANGE DIFFUSED	BLUE DIFFUSED
564-0100-291F	GREEN DIFFUSED	BLUE DIFFUSED	RED DIFFUSED
564-0100-300F	YELLOW DIFFUSED	** BLANK **	** BLANK **
564-0100-302F	YELLOW DIFFUSED	** BLANK **	GREEN DIFFUSED
564-0100-303F	YELLOW DIFFUSED	** BLANK **	YELLOW DIFFUSED
564-0100-311F	YELLOW DIFFUSED	RED DIFFUSED	RED DIFFUSED
564-0100-312F	YELLOW DIFFUSED	RED DIFFUSED	GREEN DIFFUSED
564-0100-313F	YELLOW DIFFUSED	RED DIFFUSED	YELLOW DIFFUSED
564-0100-320F	YELLOW DIFFUSED	GREEN DIFFUSED	** BLANK **
564-0100-321F	YELLOW DIFFUSED	GREEN DIFFUSED	RED DIFFUSED
564-0100-322F	YELLOW DIFFUSED	GREEN DIFFUSED	GREEN DIFFUSED
564-0100-323F	YELLOW DIFFUSED	GREEN DIFFUSED	YELLOW DIFFUSED
564-0100-331F	YELLOW DIFFUSED	YELLOW DIFFUSED	RED DIFFUSED
564-0100-332F	YELLOW DIFFUSED	YELLOW DIFFUSED	GREEN DIFFUSED
564-0100-333F	YELLOW DIFFUSED	YELLOW DIFFUSED	YELLOW DIFFUSED
564-0100-666F	WHITE WATER CLEAR	WHITE WATER CLEAR	WHITE WATER CLEAR
564-0100-700F	ORANGE DIFFUSED	** BLANK **	** BLANK **
564-0100-712F	ORANGE DIFFUSED	RED DIFFUSED	GREEN DIFFUSED
564-0100-717F	ORANGE DIFFUSED	RED DIFFUSED	ORANGE DIFFUSED
564-0100-732F	ORANGE DIFFUSED	YELLOW DIFFUSED	GREEN DIFFUSED
564-0100-772F	ORANGE DIFFUSED	ORANGE DIFFUSED	GREEN DIFFUSED
564-0100-777F	ORANGE DIFFUSED	ORANGE DIFFUSED	ORANGE DIFFUSED
*564-0100-922F	BLUE (WHITE DIFF. LENS)	GREEN DIFFUSED	GREEN DIFFUSED
564-0100-923F	BLUE DIFFUSED	GREEN DIFFUSED	YELLOW DIFFUSED
564-0100-927F	BLUE DIFFUSED	GREEN DIFFUSED	ORANGE DIFFUSED
*564-0100-932F	BLUE (WHITE DIFF. LENS)	YELLOW DIFFUSED	GREEN DIFFUSED
*564-0100-999F	BLUE (WHITE DIFF. LENS)	BLUE (WHITE DIFF. LENS)	BLUE (WHITE DIFF. LENS)

OPERATING CHARACTERISTICS AT 25°C AMBIENT												
COLOR	LUMINOUS INTENSITY @If = 10 mA WHITE @If = 20mA (mcd)			FORWARD VOLTAGE TEST CONDITION	FORWARD VOLTAGE (V)		REVERSE CURRENT Vr = 5V	PEAK WAVELENGTH (nm)	DOMINANT WAVELENGTH (nm)			VIEWING ANGLE (DEG)
	MIN	TYP	MAX		TYP	MAX			MIN	TYP	MAX	
	RED	7.4	10.0		—	If=20mA			2.0	2.8	100 μA	
GREEN	4.7	12.6	—	If=20mA	2.1	2.8	100 μA	565	564	565	573	60
YELLOW	7.4	10.0	—	If=20mA	2.1	2.8	100 μA	585	584	590	595	60
ORANGE	3.4	7.0	—	If=10mA	2.2	3.0	100 μA	600	597	602	616	60
BLUE	30.0	57	85.0	If=10mA	3.2	3.8	10 μA	468	460	467	475	100
WHITE	400	1100	1900	If=20mA	3.5	4.0	100 μA	—	—	—	—	45

ABSOLUTE MAXIMUM RATINGS AT 25°C AMBIENT							
POWER DISSIPATION	mW	100	60	100	135	BLUE	WHITE
CONTINUOUS FORWARD CURRENT	mA	30	20	30	25	30	
DERATING LINEAR FROM 50°C (30°C FOR BLUE AND WHITE)	mA/°C	0.4	0.25	0.4	0.5	0.5	0.45
PEAK FORWARD CURRENT (t ≤ 100μs, D=0.1)	mA	120	80	120	90	100	
SOLDERING TEMPERATURE (5 SEC., .063" FROM BODY)	°C	260					
OPERATING TEMPERATURE	°C	-55 TO +100			-40 TO +85	-40 TO +85	
STORAGE TEMPERATURE	°C	-55 TO +100			-45 TO +100	-40 TO +100	

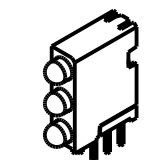
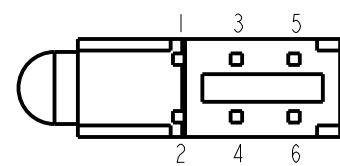
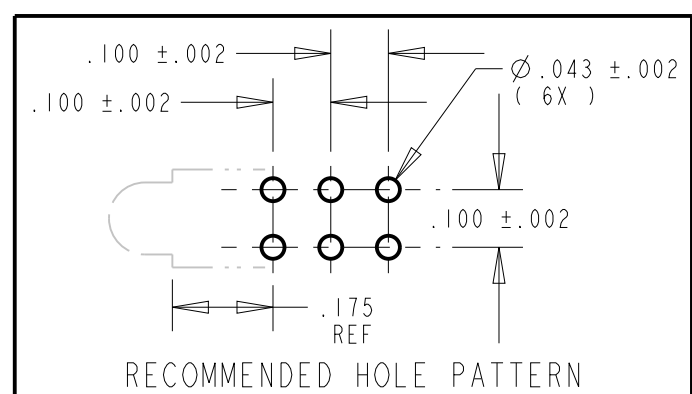
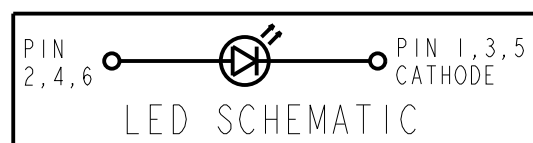
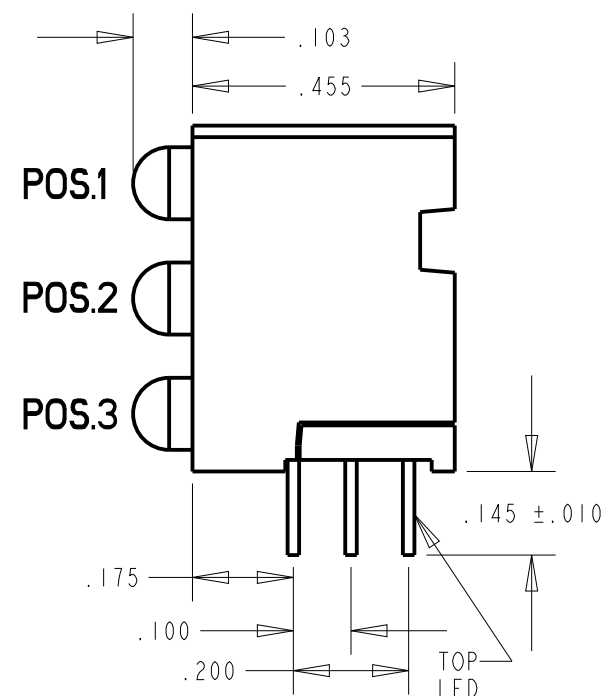
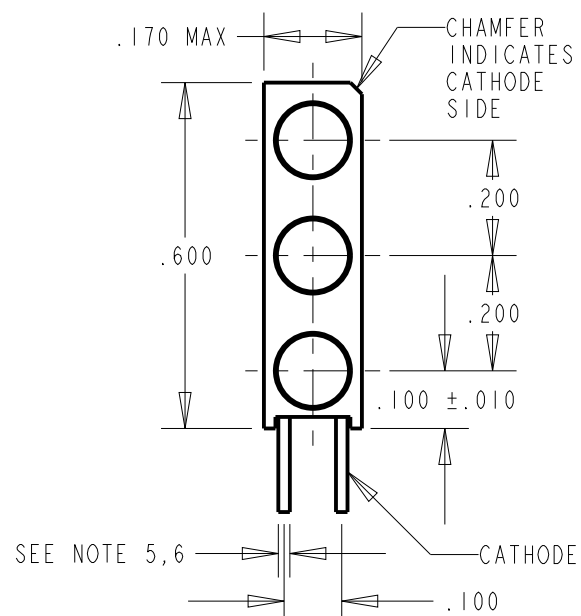

SCALE 1.000

NOTES:

- LEADS TO FIT INTO HOLES SPACED AS PER HOLE PATTERN
 - WHEN A ZERO APPEARS IN THE LAST 3 DIGITS OF THE PART NUMBER THIS MEANS NO LAMP IN THAT POSITION.
 - LED LEAD DIMENSIONS SHOWN ARE MEASURED AT HOUSING EXIT.
 - PIN NUMBERS FOR REFERENCE ONLY, DESIGNATION NON-EXISTENT ON PARTS.
 - RED, GRN, YEL, BLUE, WHITE .018 X .016; ORANGE .018 SQ.
 - TOLERANCE ON LEAD THICKNESS TO BE ± .003.
- * ATTENTION: OBSERVE PRECAUTIONS FOR HANDLING ELECTROSTATIC SENSITIVE DEVICES.

REV	ECN NO	REVISIONS	DRN	CKD	APP	DATE
A	—	NEW RELEASE	TWC	MES	NO	8-10-05
B	—	ADDED P/N 564-0100-922F AND ESD LOGO	TWC	TC	NO	9-25-05
C	—	ADDED P/N 564-0100-200F, -201F	TWC	NO	MES	2-8-06
D	—	ADDED P/N 564-0100-173F	TC	NO	MES	11-28-06
E	—	ADDED P/N 564-0100-772F	SM	MES	NO	5-25-07
F	—	ADDED P/N 564-0100-712F	KLJ	NO	AV	4-10-08
G	—	ADDED P/N 564-0100-229F; UPDATED BLUE SPECS.	KLJ	NO	MES	1-26-09
H	—	ADDED P/N 564-0100-217F	KLJ	NO	MES	4-2-09
J	—	UPDATED BLUE LED SPECS	AJF	KLJ	NO	6-20-11
K	—	ADDED P/N's 564-0100-102F, 209F, 219F, 717F, 732F ADDED DOMINANT WAVELENGTHS	JG	WFB	NO	4-29-13
L	—	ADDED LEAD THICKNESS TOLERANCE NOTE.	MMB	WFB	NO	6-21-13
M	—	ADDED 564-0100-129F UPDATED BLUE LED SPECS	WFB	JTD	N.O.	10/3/14
N	—	ADDED 564-0100-666F	RSK	WFB	NO	11-11-2014
O	—	UPDATED WHITE O/S TEMPS	RSK	WFB	NO	12/9/14
P	—	ADDED P/N 564-0100-279F/291F	BP	—	NO	10-03-16
Q	—	ADDED 564-0100-923F/927F	BP	—	NO	11-30-16

HUE BIN	CHROMATICITY COORDINATES FOR WHITE WATER CLEAR If = 20 mA			
	X	Y	Z	u'
A3	X	0.270	0.270	0.250
	Y	0.275	0.325	0.300
A4	X	0.270	0.250	0.250
	Y	0.275	0.250	0.200
B3	X	0.290	0.290	0.270
	Y	0.300	0.350	0.325
B4	X	0.290	0.270	0.270
	Y	0.300	0.275	0.225
C3	X	0.310	0.310	0.290
	Y	0.325	0.375	0.350
C4	X	0.310	0.290	0.290
	Y	0.325	0.300	0.250
D3	X	0.330	0.330	0.310
	Y	0.350	0.400	0.375
D4	X	0.330	0.310	0.310
	Y	0.350	0.325	0.275

COLOR COORDINATES MEASUREMENT ALLOWANCE ± 0.01

IV BIN	LUMINOUS INTENSITY (mcd), If = 20mA	
	MIN.	MAX.
LM	400	680
NP	680	1150
QR	1150	1900

LUMINOUS INTENSITY MEASUREMENT ALLOWANCE IS 15%

RoHS Compliant 564-0100-XXXF Thru-hole CBI

Part Numbers with the "F" suffix ending are RoHS Compliant. Example: 564-0100-002F, 564-0100-999F. The bag packaging is marked with "RoHS Compliant" label or equivalent markings. Parts can be wave soldered, dip soldered, or hand soldered using typical lead-free soldering process with max 260°C temperature for 5 seconds.

THIS DRAWING AND THE CONTENTS HEREIN ARE CONFIDENTIAL AND THE SOLE PROPERTY OF DIALIGHT. REPRODUCTION OF THIS DRAWING OR CONSTRUCTION OF ANY PARTS WITHIN THIS DRAWING ARE FORBIDDEN WITHOUT THE WRITTEN CONSENT OF DIALIGHT.		
SCALE: DRAWING SCALE ALL DIM'S IN: INCHES (MM)	DRAWING NUMBER C-17281	REV Q
TOLERANCES: UNLESS OTHERWISE SPECIFIED FRACTIONS: ±1/64 DECIMALS (.XX): ±.01 DECIMALS (.XXX): ±.005 DECIMALS (.XXXX): ±.0005 ANGLES: ±1°	TITLE STANDARD 3X1 CBI BLOCK RoHS COMPLIANT	MATERIAL
FINISH:	1501 ROUTE 34 SOUTH FARMINGDALE, NJ 07727	
FSCM 83330	SHEET 1 OF 1	FAMILY TABLE:

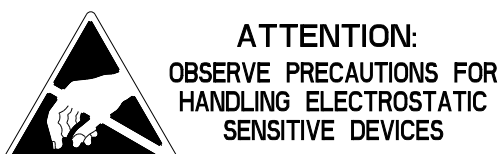

X-ON Electronics

Largest Supplier of Electrical and Electronic Components

Click to view similar products for [LED Circuit Board Indicators](#) category:

Click to view products by [Dialight](#) manufacturer:

Other Similar products are found below :

[568-0701-841F](#) [LTL-4221NH129](#) [LTL-42DGNMHDP1](#) [HLMP1521101](#) [HLMP1523802F](#) [HLMP1700101F](#) [HLMP1700104F](#) [BHA-1564-G](#)
[SMF-HM1530YD-305](#) [SSF-LXH409SYSUGW](#) [AM2520EHSGD](#) [HLMP1301104F](#) [HLMP1385101F](#) [HLMP1421101](#) [HLMP1503103F](#)
[HLMP1503104F](#) [HLMP1700102F](#) [HLMP1700106F](#) [HLMP1700107F](#) [HLMP1790101F](#) [HLMP1790103F](#) [LTL-4211NHBP](#) [5390H3](#) [551-](#)
[2802F](#) [552-0794-810F](#) [553-0222-812F](#) [HT3-BC-T](#) [564-0700-831F](#) [WP59BLGEW](#) [103-3101-1231-403](#) [5502407811F](#) [550-3007-810F](#) [551-](#)
[3307MF](#) [552080-1](#) [573-2399-100F](#) [592-2020-302F](#) [5932-927-2701-3F](#) [SMF-HM1530SRD-509](#) [SSF-LXH100MID](#) [SSF-LXH2103SRSDRP](#)
[SSF-LXH555USBW](#) [WP937SB/4YGW](#) [WP937EB2EGW](#) [551-0312-802F](#) [553-0110-802F](#) [561-5501-050F](#) [6202T3-5VLC](#) [LTL-307G08A-D](#)
[CMD57164](#) [568-2231-313F](#)