

REV	ECN NO	REVISIONS	DRN	CKD	APP	DATE
A		NEW RELEASE	KLJ	m.e.	1/30/08	

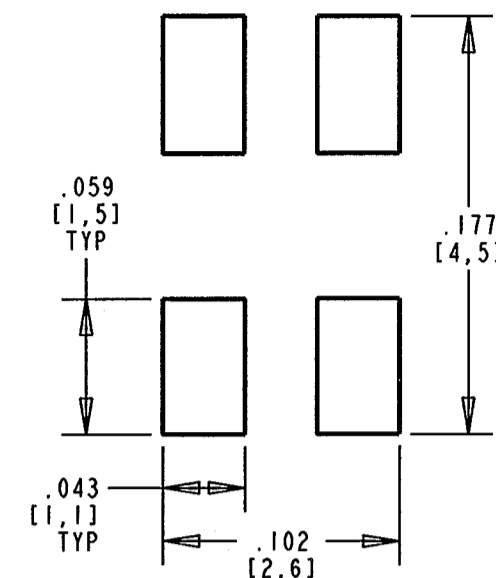

RECOMMENDED SOLDER PAD LAYOUT

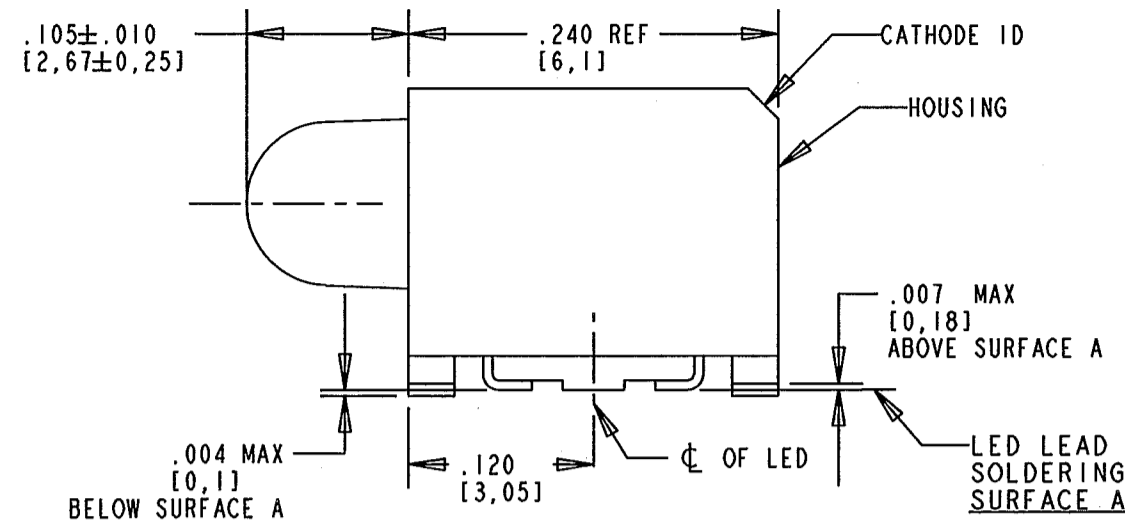
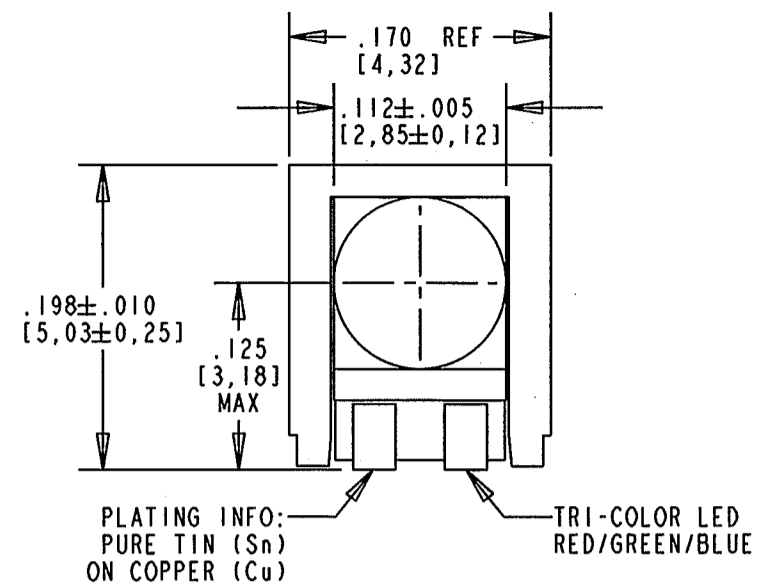
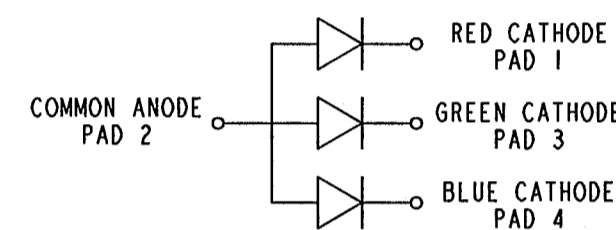
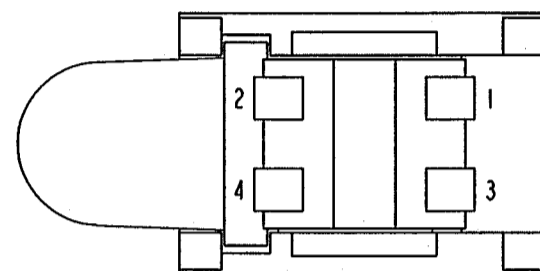

NOTES:

- MILLIMETER DIMENSIONS SHOWN FOR REFERENCE ONLY.
- PAD NUMBERS FOR REFERENCE ONLY, DESIGNATION NON-EXISTENT ON PART.
- STORAGE CONDITIONS FOR TAPED PRODUCT: RE-TAPING MAY BE NECESSARY FOR PRODUCT STORED MORE THAN TWELVE MONTHS.
- ORDER QUANTITY IS LED ASSEMBLIES, NOT REELS.
- 831F SUFFIX MEANS PARTS ARE PACKED ON A 20 PCS SAMPLE STRIP.
-832F SUFFIX MEANS PARTS ARE PACKED ON A 7 INCH REEL, 400 PCS/REEL.
-833F SUFFIX MEANS PARTS ARE PACKED ON A 13 INCH REEL, 1600 PCS/REEL.
- LENS MOVEMENT IN RELATIONSHIP TO THE HOUSING IS:
.009" T.I.R. VERTICALLY.
.007" T.I.R. HORIZONTALLY.
- FRONT AND REAR TERMINALS OF ASSEMBLY TO BE WITHIN .005 COPLANARITY.
- DIALIGHT PART NUMBERS: 591-3501-831F, 591-3501-832F, 591-3501-833F.
- DEVICE HAS A MOISTURE SENSITIVITY LEVEL "2a" CAUTION LABEL APPLIED AS PER JEDEC STD. 033.
- THIS ASSEMBLY CONTAINS ELECTROSTATIC DISCHARGE SENSITIVE DEVICES (ESDS). MAINTAIN ALL PRECAUTIONARY MEASURES DURING ASSEMBLY, HANDLING, AND STORAGE IN ACCORDANCE WITH IPC-A-610.

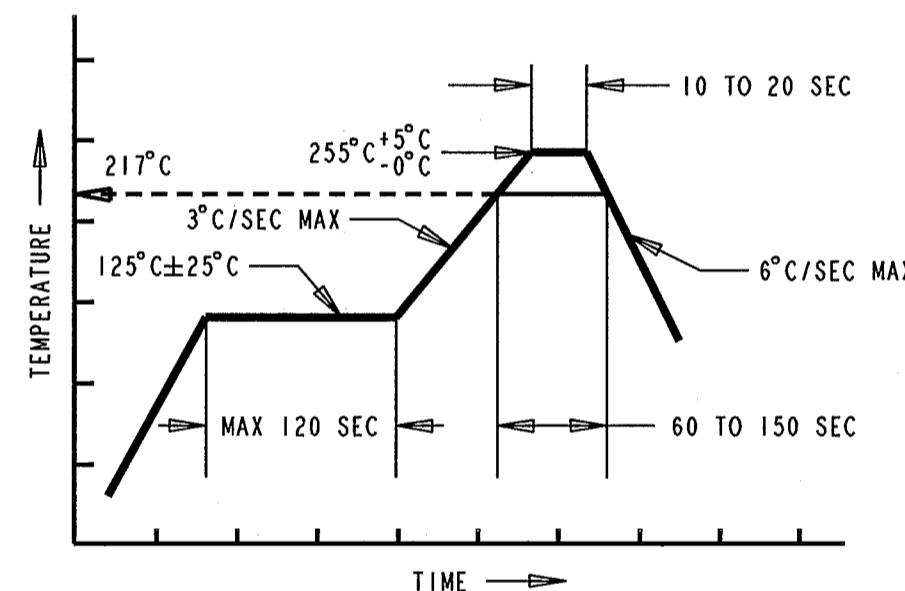

* THE TIME FROM 25°C TO PEAK TEMPERATURE = 6 MINUTES MAX

RECOMMENDED RoHS SOLDER PROFILE

OPERATING CHARACTERISTICS AT 25°C AMBIENT					
LED CHARACTERISTICS	COLOR	TYP	MAX	UNITS	TEST CONDITIONS
LUMINOUS INTENSITY	RED GREEN BLUE	60 150 30		mc d	I _F = 20 mA
FORWARD VOLTAGE	RED GREEN BLUE	1.9 3.4 3.4	2.4 4.05 4.05	V	I _F = 20 mA
REVERSE CURRENT	RED GREEN BLUE		10 10 100	µA	V _R = 5V
PEAK WAVELENGTH	RED GREEN BLUE	635 523 468		nm	
DOMINANT WAVELENGTH	RED GREEN BLUE	626 525 470		nm	
VIEWING ANGLE	ALL	40		DEGREE	

ABSOLUTE MAXIMUM RATINGS AT 25 °C AMBIENT				
	RED	GREEN	BLUE	UNIT
POWER DISSIPATION	72	120	120	mW
CONTINUOUS FORWARD CURRENT	30	20	20	mA
DERATE LINEARLY FROM 80°C (BLUE & GREEN FROM 70°C) BASED ON 1 CHIP ON	1.00	0.5	0.5	mA/°C
PEAK FORWARD CURRENT	100	100	100	mA
REVERSE VOLTAGE	5	5	5	V
OPERATING TEMPERATURE RANGE	-55 TO +100			°C
STORAGE TEMPERATURE RANGE	-55 TO +100			°C
JUNCTION TEMPERATURE	+110			°C

TAPING SPECIFICATION

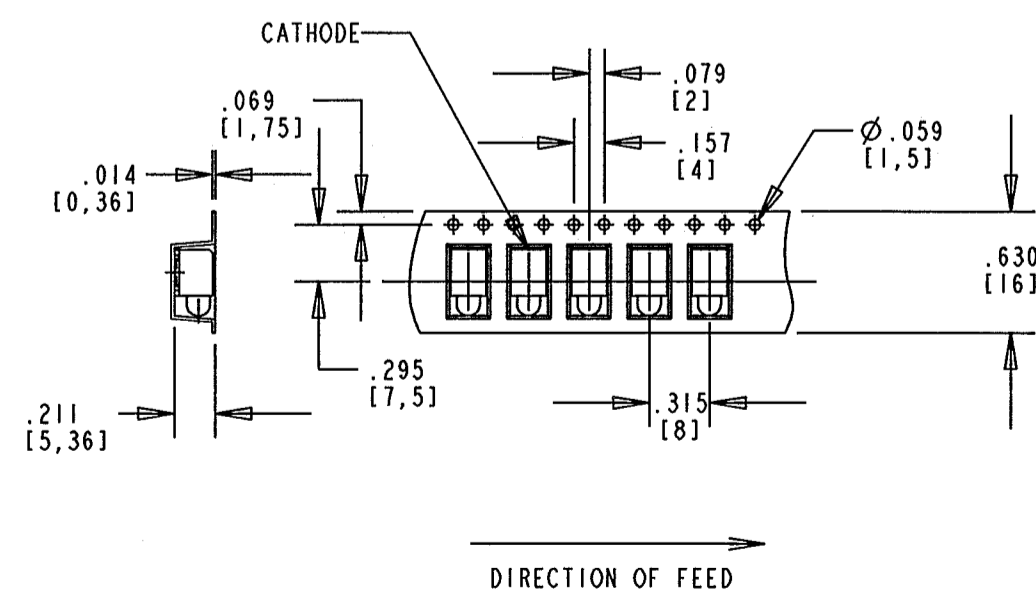

TOLERANCE: .004 UNLESS OTHERWISE SPECIFIED.
MILLIMETER DIMENSIONS SHOWN FOR REFERENCE ONLY.

REEL SPECIFICATION

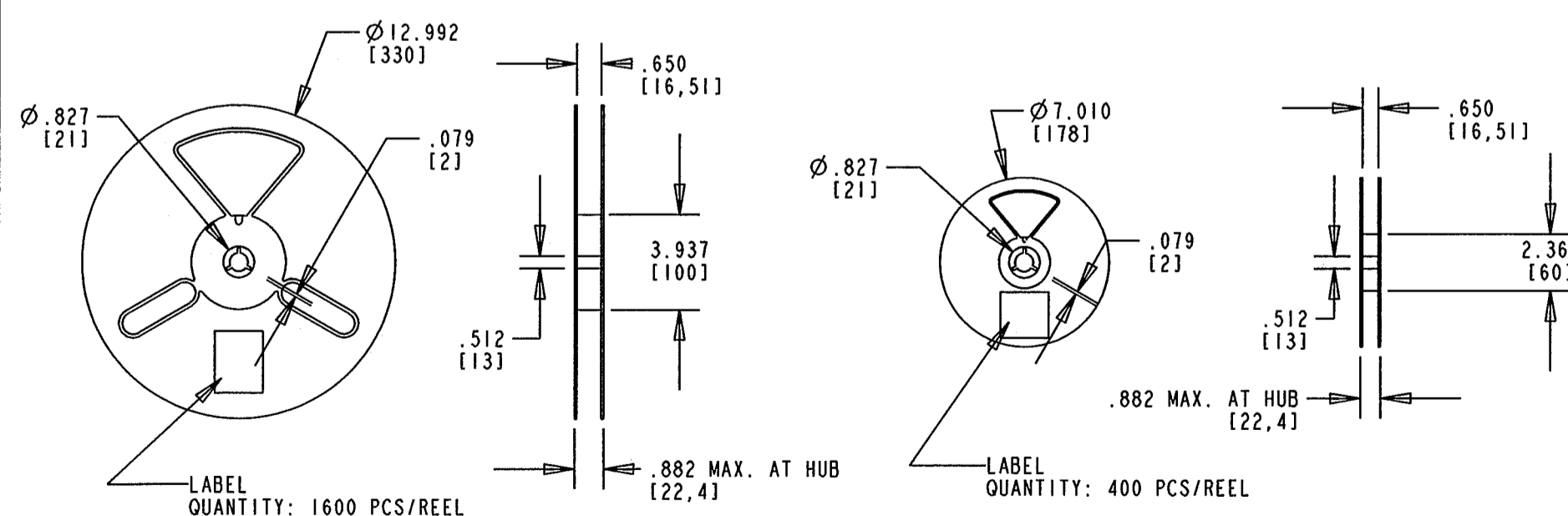

13 INCH DIA. REEL SPECIFICATIONS

7 INCH DIA. REEL SPECIFICATIONS

RoHS Compliant 591-3501-83XF

Part Numbers with the "F" suffix ending are RoHS Compliant. For example: 591-3501-832F. Reel and bag packaging are marked with "RoHS Compliant" label or equivalent markings. These parts can be used with RoHS reflow profile. Parts can be wave soldered, dip soldered or hand soldered using typical lead-free soldering process with max 260°C temp. for 5 sec.



ATTENTION:
OBSERVE PRECAUTIONS FOR
HANDLING ELECTROSTATIC
SENSITIVE DEVICES

THIS DRAWING AND THE CONTENTS HEREIN ARE CONFIDENTIAL AND THE SOLE PROPERTY OF DIALIGHT. REPRODUCTION OF THIS DRAWING OR CONSTRUCTION OF ANY PARTS WITHIN THIS DRAWING ARE FORBIDDEN WITHOUT THE WRITTEN CONSENT OF DIALIGHT.		
SCALE: DRAWING SCALE ALL DIM'S IN: INCHES (MM)	DRAWING NUMBER C-17620	REV A
TOLERANCES: UNLESS OTHERWISE SPECIFIED FRACTIONS: ±1/64 DECIMALS (.XX): ±.01 DECIMALS (.XXX): ±.005 DECIMALS (.XXXX): ±.0005 ANGLES: ±1°	TITLE Y/B BI-COLOR PRISM - ROUND LENS RoHS COMPLIANT	
FINISH:	MATERIAL	
FSCM 83330	Dialight 1501 ROUTE 34 SOUTH FARMINGDALE, NJ 07727	
SHEET 1 OF 1 FAMILY TABLE:		

X-ON Electronics

Largest Supplier of Electrical and Electronic Components

Click to view similar products for [LED Circuit Board Indicators](#) category:

Click to view products by [Dialight](#) manufacturer:

Other Similar products are found below :

[568-0701-841F](#) [LTL-4221NH129](#) [LTL-42DGNMHDP1](#) [HLMP1521101](#) [HLMP1523802F](#) [HLMP1700101F](#) [HLMP1700104F](#) [BHA-1564-G](#)
[SMF-HM1530YD-305](#) [SSF-LXH409SYSUGW](#) [AM2520EHSGD](#) [HLMP1301104F](#) [HLMP1385101F](#) [HLMP1421101](#) [HLMP1503103F](#)
[HLMP1503104F](#) [HLMP1700102F](#) [HLMP1700106F](#) [HLMP1700107F](#) [HLMP1790101F](#) [HLMP1790103F](#) [LTL-4211NHBP](#) [5390H3](#) [551-](#)
[2802F](#) [552-0794-810F](#) [553-0222-812F](#) [HT3-BC-T](#) [564-0700-831F](#) [WP59BLGEW](#) [103-3101-1231-403](#) [5502407811F](#) [550-3007-810F](#) [551-](#)
[3307MF](#) [552080-1](#) [573-2399-100F](#) [592-2020-302F](#) [5932-927-2701-3F](#) [SMF-HM1530SRD-509](#) [SSF-LXH100MID](#) [SSF-LXH2103SRSDRP](#)
[SSF-LXH555USBW](#) [WP937SB/4YGW](#) [WP937EB2EGW](#) [551-0312-802F](#) [553-0110-802F](#) [561-5501-050F](#) [6202T3-5VLC](#) [LTL-307G08A-D](#)
[CMD57164](#) [568-2231-313F](#)