

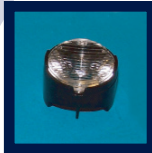

LUMILEDS LUXEON® 20mm LENSES AND HOLDERS

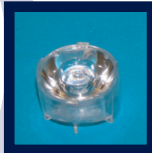

OPERATING CONDITIONS

- ▲ 105°C max temperature

MATERIALS/FINISH

- ▲ Lenses are optical grade PMMA acrylic
- ▲ Holders are made of durable polycarbonate

MECHANICAL DIMENSIONS

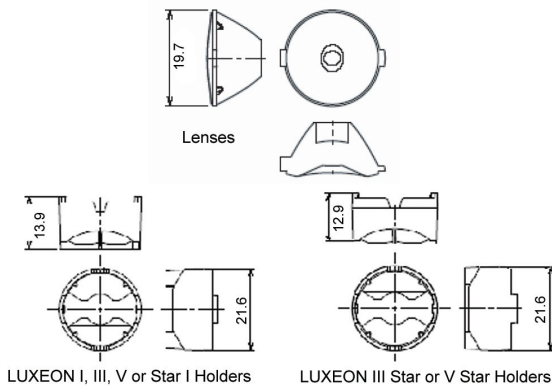

FEATURES / BENEFITS

- ▲ For LUXEON I, III and V emitters & Stars
- ▲ Available in spot, medium, wide and oval lenses
- ▲ Snap-in optics
- ▲ Greater than 85% efficiency

ORDERING INFORMATION

HOLDERS			
Dialight P/N	Reference P/N	Description	
OHES1WH	OH-ES1-WH	LUXEON I, III, V & Star I - Direct PCB Mount (White)	
OHES1BK	OH-ES1-BK	LUXEON I, III, V & Star I - Direct PCB Mount (Black)	
OHES1CL	OH-ES1-CL	LUXEON I, III, V & Star I - Direct PCB Mount (Clear)	
OHS35WH	OH-S35-WH	For Drop-Through Mount & LUXEON Star III & V (White)	
OHS35BK	OH-S35-BK	For Drop-Through Mount & LUXEON Star III & V (Black)	
OHS35CL	OH-S35-CL	For Drop-Through Mount & LUXEON Star III & V (Clear)	
LENS			
Dialight P/N	Reference P/N	Description	Degree*
OP005	OP-005	Spot Lens	5°
OP015	OP-015	Medium Lens	15°
OP025	OP-025	Wide Lens	25°
OP520	OP-520	Oval Lens	5° X 20°
*All angles refer to half divergence			

Dialight reserves the right to make changes at any time in order to supply the best product possible.

Dialight Corporation
 1501 Route 34 South • Farmingdale, NJ 07727 USA
 Tel: (1) 732-919-3119 • Fax: (1) 732-751-5778 • www.dialight.com



MDEXLUMLUX_B

PHOTOMETRIC DATA

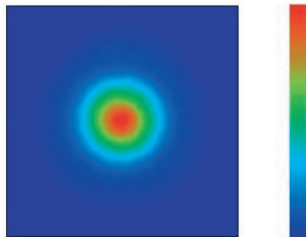

Spot Lens

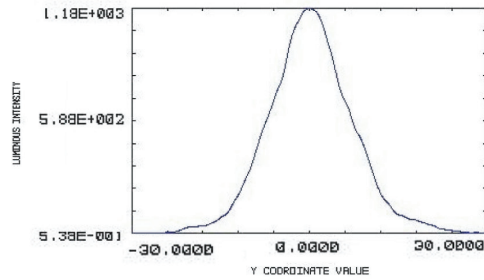

Typical half-angle divergence 5°
when using LUXEON I Cool White

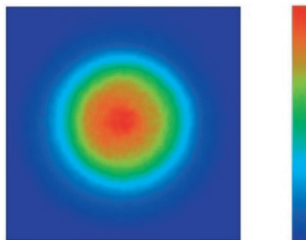

Medium Lens

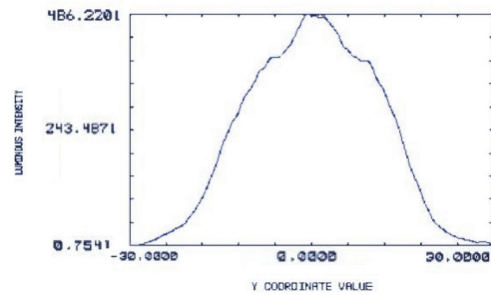

Typical half-angle divergence 15° when
using LUXEON I Cool White

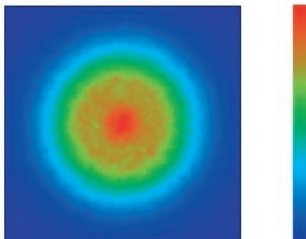

Wide Lens

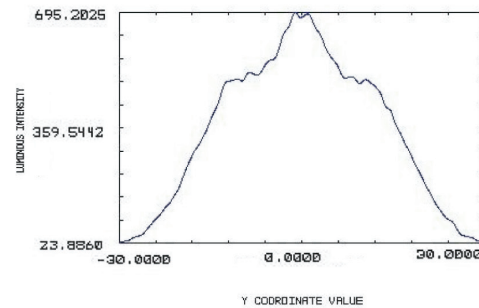

Typical half-angle divergence 25° when
using LUXEON I Cool White

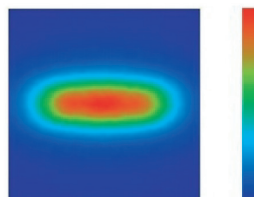

Oval Lens

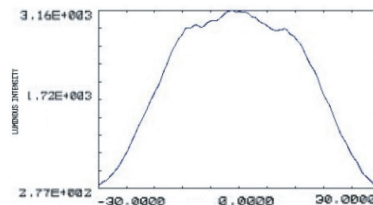

Horizontal

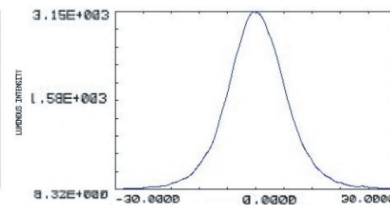

Vertical

Typ. half-angle divergence
5° X 20° LUXEON I Cool White

Dialight reserves the right to make changes at any time
in order to supply the best product possible.

Dialight Corporation
1501 Route 34 South • Farmingdale, NJ 07727 USA
Tel: (1) 732-919-3119 • Fax: (1) 732-751-5778 • www.dialight.com



X-ON Electronics

Largest Supplier of Electrical and Electronic Components

Click to view similar products for [LED Lighting Lenses Assemblies](#) category:

Click to view products by [Dialight](#) manufacturer:

Other Similar products are found below :

[FCN12592_LE1-D-COP](#) [CA16129_OLGA-W](#) [CA16370_HB-SQ-W](#) [FN15972_RONDA-ZT45-C](#) [CS15759_HB-2X2MX-8-W](#)
[CA16435_LXP2-SS-WAS](#) [CS13756_STRADA-IP-2X6-DWC-PC](#) [CN16210_GABRIELLA-MIDI-W](#) [CP17137_CARMEN-M2-C](#)
[CA16015_STRADA-SQ-SCL](#) [CP17594_TINA-SC-RS](#) [CS15767_HB-2X2MX-8-M](#) [CP10960_RGBX-SS](#) [CP12395_LXP3-W](#)
[CP12939_LARISA-RS-CLIP16](#) [C14636_XTM-PF-ADAPTER](#) [CA11819_STRADA-SQ-T-DW](#) [CA14508_G2-LXP2-D](#)
[CA14601_VERONICA-SQ-MINI-RS](#) [FCP13895_SEANNA-A](#) [CP12943_LARISA-O-CLIP16](#) [FP11124_LISA2-O-PIN](#) [CS14597_HB-IP-2X6-](#)
[O](#) [CP14995_FLORENTINA-HLD-O](#) [CS15158_STRADA-IP-2X6-T4-B](#) [CS16323_STRADELLA-IP-28-HB-M](#) [FN15264_STELLA-HB-](#)
[WWW](#) [FN15971_RONDA-WAS-C](#) [CA15584_ZORYA-MINI-TAPE](#) [FA15229_ROSE-MRK-S](#) [FA15233_ROSE-MRK-W](#)
[FCN13552_CRYSTAL-RS](#) [FS15626_FLORENCE-3R-IP-Z90](#) [CA14505_G2-LXP2-RS2-P](#) [CP12944_LARISA-W-CLIP8](#) [FCN12775_IRIS-O](#)
[CP15304_LARISA-RS-PIN](#) [CA15519_VERONICA-SQ-MINI-D](#) [FP14414_LISA2-O-PIN](#) [LL01CR-DF60L06-M2](#) [FN15977_RONDA-WAS2](#)
[CA14366_FLARE-MAXI-TAPE](#) [CA14392_LXP2-O-WAS](#) [CA14442_VERONICA-SQ-W](#) [CA14509_G2-LXP2-M-P](#) [CA15231_VERONICA-](#)
[SQ-MINI-W](#) [FP11002_LISA2-W-PIN](#) [CA13628_G2-LAURA-RS-P](#) [CA14602_VERONICA-SQ-MINI-O](#) [CA15230_VERONICA-SQ-MINI-](#)
[M](#)