

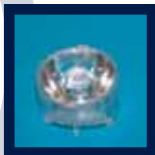

OSRAM GOLDEN DRAGON®

20mm LENSES AND HOLDERS



OPERATING CONDITIONS

- ▲ 105° C max temperature

MATERIALS/FINISH

- ▲ Lenses are optical grade PMMA acrylic
- ▲ Holders are made of durable polycarbonate

MECHANICAL DIMENSIONS

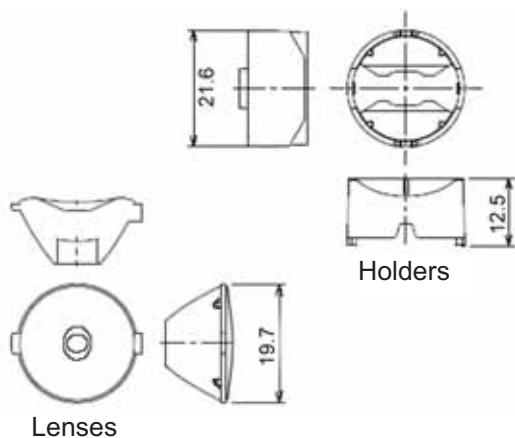

Dialight reserves the right to make changes at any time in order to supply the best product possible.

FEATURES / BENEFITS

- ▲ For Osram Golden Dragon LEDs
- ▲ Available in spot, medium, wide and oval lenses
- ▲ Snap-in sub-lens
- ▲ Greater than 85% efficiency

ORDERING INFORMATION

HOLDERS			
Dialight P/N	Reference P/N	Description	
OHGDBK	OH-GD-BK	Osram Golden Dragon LEDs - Black	
OHGDCL	OH-GD-CL	Osram Golden Dragon LEDs - Clear	
OHGDWH	OH-GD-WH	Osram Golden Dragon LEDs - White	
LENS			
Dialight P/N	Reference P/N	Description	Degree*
OP005	OP-005	Spot Lens	5°
OP015	OP-015	Medium Lens	15°
OP025	OP-025	Wide Lens	25°
OP520	OP-520	Oval Lens	5° X 20°
*All angles refer to half divergence			



Dialight Corporation

1501 Route 34 South • Farmingdale, NJ 07727 USA
 Tel: (1) 732-919-3119 • Fax: (1) 732-751-5778 • www.dialight.com



MDEXLUMOGD_A

PHOTOMETRIC DATA

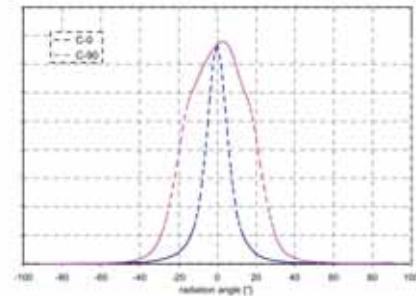
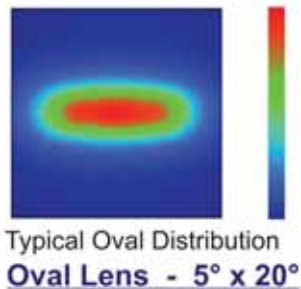
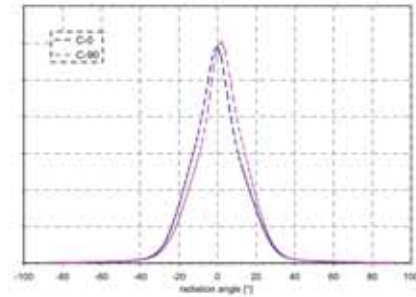
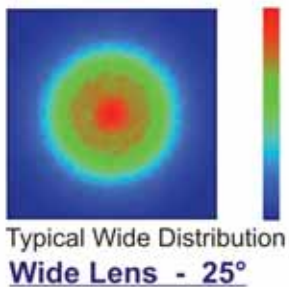
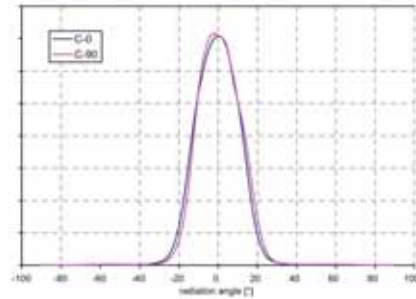
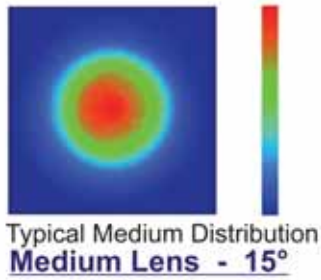
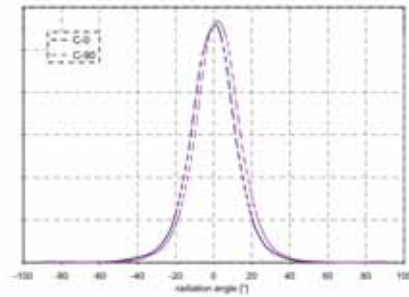
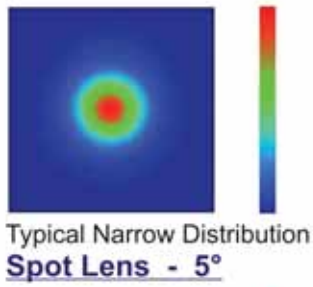

Dialight reserves the right to make changes at any time in order to supply the best product possible.



Dialight Corporation
1501 Route 34 South • Farmingdale, NJ 07727 USA
Tel: (1) 732-919-3119 • Fax: (1) 732-751-5778 • www.dialight.com



MDEXLUMOGD_A

X-ON Electronics

Largest Supplier of Electrical and Electronic Components

Click to view similar products for [LED Lighting Lenses Assemblies](#) category:

Click to view products by [Dialight](#) manufacturer:

Other Similar products are found below :

[FCN12592_LE1-D-COP](#) [CA16129_OLGA-W](#) [CA16370_HB-SQ-W](#) [FN15972_RONDA-ZT45-C](#) [CS15759_HB-2X2MX-8-W](#)
[CA16435_LXP2-SS-WAS](#) [CS13756_STRADA-IP-2X6-DWC-PC](#) [CN16210_GABRIELLA-MIDI-W](#) [CP17137_CARMEN-M2-C](#)
[CA16015_STRADA-SQ-SCL](#) [CP17594_TINA-SC-RS](#) [CS15767_HB-2X2MX-8-M](#) [CP10960_RGBX-SS](#) [CP12395_LXP3-W](#)
[CP12939_LARISA-RS-CLIP16](#) [C14636_XTM-PF-ADAPTER](#) [CA11819_STRADA-SQ-T-DW](#) [CA14508_G2-LXP2-D](#)
[CA14601_VERONICA-SQ-MINI-RS](#) [FCP13895_SEANNA-A](#) [CP12943_LARISA-O-CLIP16](#) [FP11124_LISA2-O-PIN](#) [CS14597_HB-IP-2X6-](#)
[O](#) [CP14995_FLORENTINA-HLD-O](#) [CS15158_STRADA-IP-2X6-T4-B](#) [CS16323_STRADELLA-IP-28-HB-M](#) [FN15264_STELLA-HB-](#)
[WWW](#) [FN15971_RONDA-WAS-C](#) [CA15584_ZORYA-MINI-TAPE](#) [FA15229_ROSE-MRK-S](#) [FA15233_ROSE-MRK-W](#)
[FCN13552_CRYSTAL-RS](#) [FS15626_FLORENCE-3R-IP-Z90](#) [CA14505_G2-LXP2-RS2-P](#) [CP12944_LARISA-W-CLIP8](#) [FCN12775_IRIS-O](#)
[CP15304_LARISA-RS-PIN](#) [CA15519_VERONICA-SQ-MINI-D](#) [FP14414_LISA2-O-PIN](#) [LL01CR-DF60L06-M2](#) [FN15977_RONDA-WAS2](#)
[CA14366_FLARE-MAXI-TAPE](#) [CA14392_LXP2-O-WAS](#) [CA14442_VERONICA-SQ-W](#) [CA14509_G2-LXP2-M-P](#) [CA15231_VERONICA-](#)
[SQ-MINI-W](#) [FP11002_LISA2-W-PIN](#) [CA13628_G2-LAURA-RS-P](#) [CA14602_VERONICA-SQ-MINI-O](#) [CA15230_VERONICA-SQ-MINI-](#)
[M](#)