

REVISION RECORD				
REV	ECN	DESCRIPTION	DRFT	DATE

NOTES1:

UL Standard

- 1.Rated Voltage/Current : 300V / 12A
- 2.Torque Value : M2.5 , 3.54Lb.in
- 3.Wire Range : 26~14AWG

IEC Standard

- 1.Rated Voltage/Current : 250V / 15A
- 2.Torque Value : M2.5 , 0.4N.m
- 3.Wire Range : 1.5mm<sup>2</sup>

NOTES2:

- 1.Dimension shall be interpreted per ASME Y14.5-2009
- 2.Pitch : 5.0/5.08mm, Poles : N=02~16P
- 3.Stripping length : 5~6mm
- 4.Withstanding Voltage : AC2000V/1Min.
- 5.Operating temperature: -40°C~+105°C
- 6.Undimensioned Tolerances:

Pitch range in mm		Nominal dimension range in mm					
To	Over	To	To	To	To	To	0.1/10
6	10	6	10	30	60	100	150
±0.15	±0.20	±0.30	±0.30	±0.50	±0.70	±1.00	±1.30
							±2'

7.RoHS Compliance

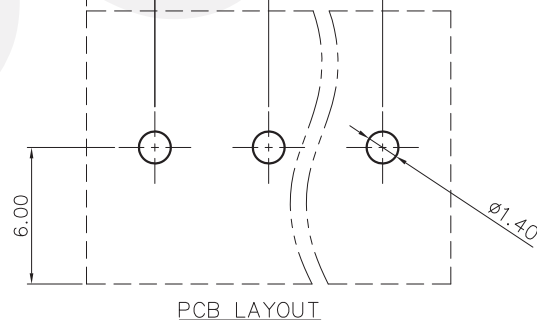
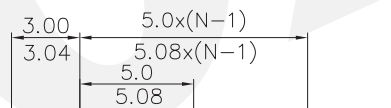
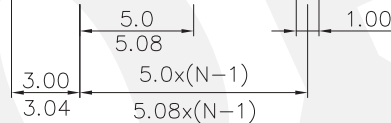
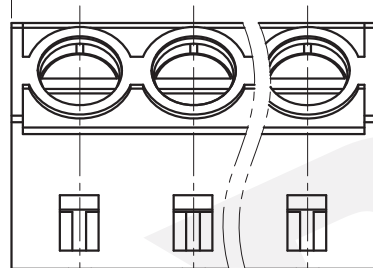
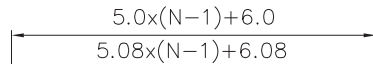
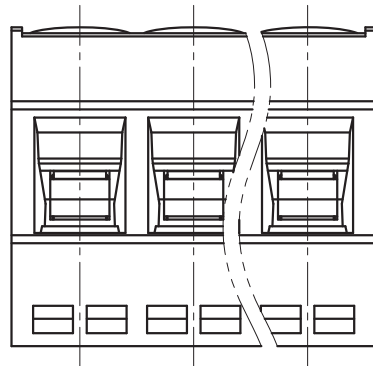
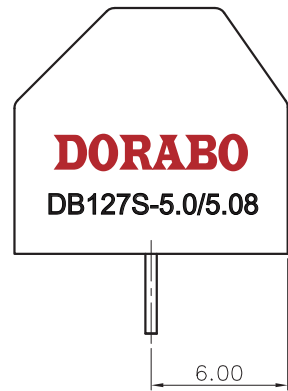

PCB LAYOUT

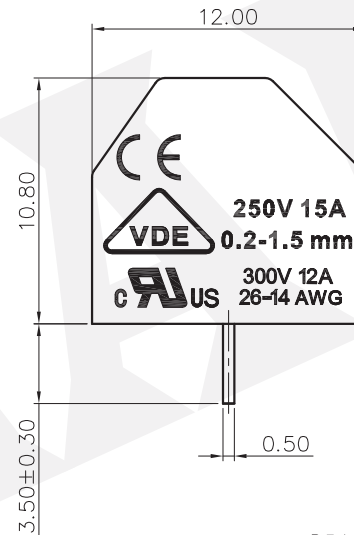

DB127S - 5.0/5.08 - XXP - 1Y - 00A (H)  
 (Series No.) (Pitch) (Poles) (Single Pitch) (RoHS) 00A-(Standard)  
 (Color): 1.(Grey)2.(Blue)3.(Black)4.(Green)5.(Orange)6.(Red)7.(Transparent)8.(Yellow)9.(White)

DETACHED LISTS	PART NO.:	DORABO 慈溪市地博电子有限公司 CIXI DORABO ELECTRONICS CO.,LTD			
	APPD:	NAME: DB127S-5.0/5.08-XXP-1Y-00A(H)			
	CHKD:				
	DRFT:	TITLE: CUSTOMER DRAWING	REV	DO	
THIRD ANGLE PROJECTION		DRAWING NO.:	SHEET	1/1	
		MM (INCH)	DO NOT SCALE DRAWING	SCALE	1:1

## X-ON Electronics

Largest Supplier of Electrical and Electronic Components

*Click to view similar products for [Fixed Terminal Blocks](#) category:*

*Click to view products by [DIBO](#) manufacturer:*

Other Similar products are found below :

[MBE-1512](#) [MBE-1520](#) [MBE-154](#) [MBE-156](#) [MBES-156](#) [MH-2512](#) [MHE-132](#) [MHE-163](#) [MI-254 \(35\)](#) [MI-272](#) [MPT-275](#) [ELM10110G](#)  
[BA311TU](#) [BA411SU](#) [MV-253/NCNOC](#) [MV-254-D](#) [MV-255](#) [MV-493](#) [MVE-252](#) [MVE-253](#) [MVE-273](#) [MVEB-153](#) [1700096](#) [1705142](#)  
[1712417](#) [1713088](#) [1745195](#) [1760594](#) [1-796689-8](#) [1-796692-6](#) [1800114](#) [20020314-C121B01LF](#) [20020316-G041B01LF](#) [KP03215000J0G](#)  
[KP04215000J0G](#) [S451](#) [29.007](#) [29.116](#) [30.103](#) [30.106](#) [30.503](#) [30.608](#) [30.755](#) [30.756](#) [30.853](#) [9872-0-00-15-00-00-33-0](#) [996750](#) [1706303](#)  
[1710052](#) [1712418](#)