

REVISION RECORD

REV	ECN	DESCRIPTION	DRFT	DATE
-----	-----	-------------	------	------

NOTES1:

UL Standard

- 1.Rated voltage/current : 300V / 8A
- 2.Withstanding voltage : AC1600V/1Min.

IEC Standard

1. Pollution Degree	2
Overvoltage Category	II
Rate Impulse Voltage(KV)	2.5KV
Rate Voltage(V)	250V
Rate Current(A)	7A

NOTES2:

- 1.Dimension shall be interpreted per ASME Y14.5-2009
- 2.Pitch : 3.5/3.81mm, Poles : N=02~22P
- 3.Operating temperature: -40°C~+105°C
- 4.Undimensioned tolerances:

Pitch range in mm		Nominal dimension range in mm				0.1/10
TO	Over	TO	Over	TO	Over	
6	10	6	10	30	60	±0.15
6	10	10	24	30	60	
6	10	10	24	30	100	±0.30
6	10	10	24	30	150	
6	10	10	24	30	150	±0.50
6	10	10	24	30	150	
6	10	10	24	30	150	±1.00
6	10	10	24	30	150	
6	10	10	24	30	150	±1.30
6	10	10	24	30	150	
6	10	10	24	30	150	±2'

5.RoHS Compliance

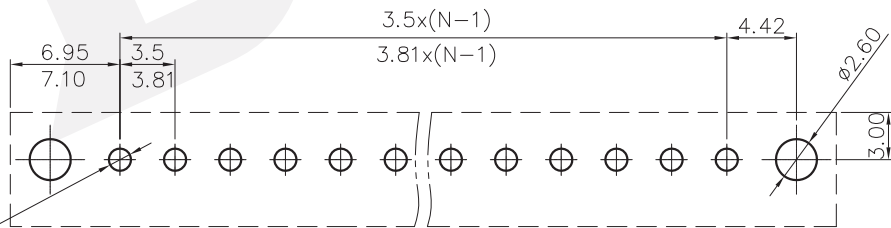
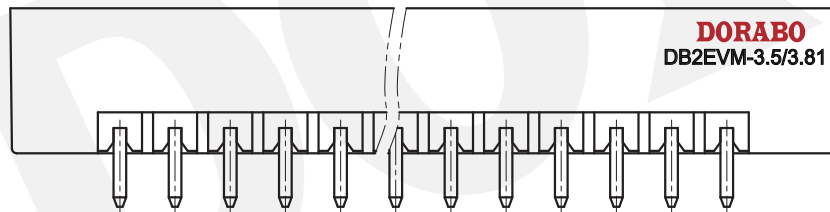
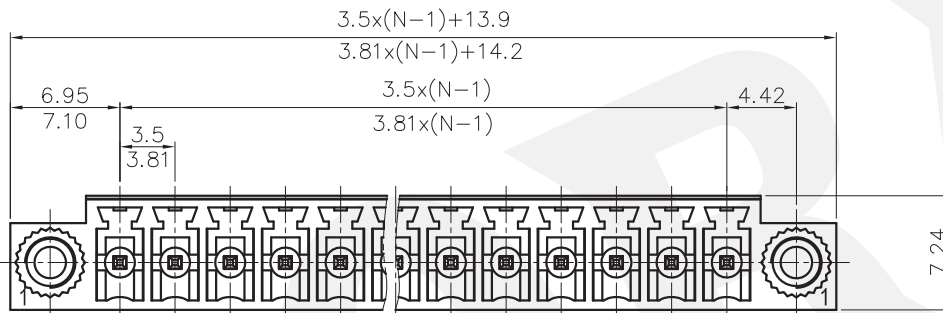
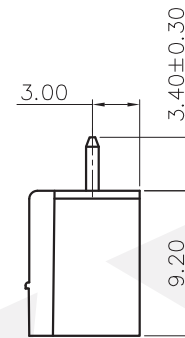
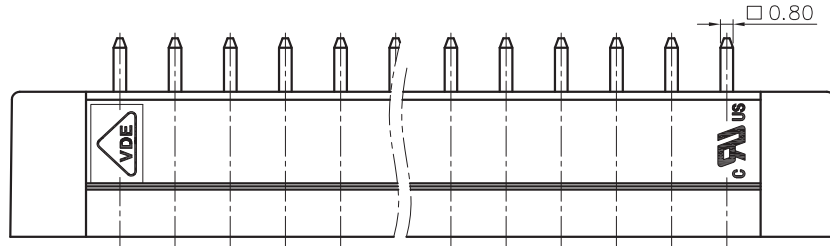
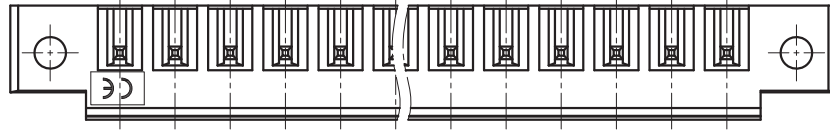

PCB LAYOUT

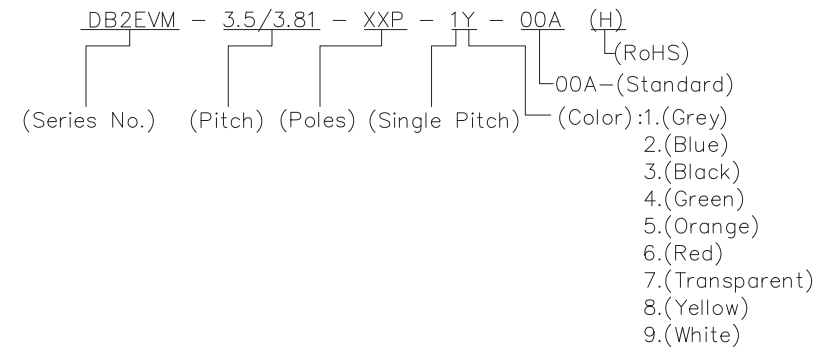

DETACHED LISTS	PART NO.:	/			
	APPD:	/			
	CHKD:	/			
	DRFT:	/			
NAME:		<b>DORABO</b> 慈溪市地博电子有限公司 CIXI DORABO ELECTRONICS CO.,LTD			
TITLE:		CUSTOMER DRAWING		REV	DO
DRAWING NO.:		/		SHEET	1/1
THIRD ANGLE PROJECTION		MM (INCH)	DO NOT SCALE DRAWING	SCALE	1:1

φ1.40

## X-ON Electronics

Largest Supplier of Electrical and Electronic Components

*Click to view similar products for [Pluggable Terminal Blocks](#) category:*

*Click to view products by [DIBO](#) manufacturer:*

Other Similar products are found below :

[57.510.0053](#) [MC 1.5/ 6-ST-3.5 GY AU](#) [ET02015000J0G](#) [734-104](#) [734-302](#) [860505](#) [860516](#) [860810](#) [GBPACX-12](#) [93.731.4953.0](#) [PV05-5,08-K](#) [PVP03-3,50](#) [PVP04-3,50](#) [PVS02-5,00](#) [1-1986160-3](#) [1377680000](#) [1531000000](#) [1546228-5](#) [ELFP03110](#) [ELFT07250](#) [ELVD12100](#) [ELVF09400](#) [ELVP03100](#) [ELXH071G0E](#) [1700410](#) [1702246](#) [1705229](#) [1714537](#) [1717806](#) [1719600](#) [1728941](#) [1734692](#) [1734795](#) [1740291](#) [1740628](#) [1746952](#) [1750207](#) [1752865](#) [1754115](#) [1754144](#) [1756913](#) [1760051](#) [1760336](#) [1765111](#) [1776388](#) [1777701](#) [1783410](#) [1800227](#) [1801080](#) [1809474](#)