

Adapter Boards

User's Manual

019-0119 • 060930-C

No part of the contents of this manual may be reproduced or transmitted in any means without the express written permission of Rabbit Semiconductor Inc. Permission is granted to make one or more copies as long as the copyright notice therein is included. These copies of the manuals may not be let or sold for profit without the express written permission of Rabbit Semiconductor.

Rabbit Semiconductor reserves the right to make changes and improvements to its products without providing notice.

Trademarks

- Dynamic C is a registered trademark of Rabbit Semiconductor Inc.
- Windows is a registered trademark of Microsoft Corporation.
- PLCBus is a trademark of Rabbit Semiconductor Inc.

The latest revision of this manual is available on the Rabbit Semiconductor website, www.rabbit.com, for free, unregistered download.

Rabbit Semiconductor Inc.

www.rabbit.com

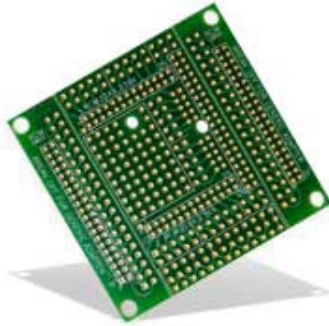

TABLE OF CONTENTS

Adapter Boards Use	5
<i>Rabbit 2000 Based RabbitCore Modules</i>	
RCM2000	6
RCM2100	8
RCM2200	10
RCM2300	11
BL1800	12
Universal 2 mm to 0.1" Adapter	14
<i>Rabbit 3000 Based RabbitCore Modules</i>	
RCM3000/RCM3100/RCM3200	16
RCM3400	18
Appendix. Specifications	21
Mechanical Specifications	21
Schematics	23



Adapter Board for Rabbit 2000 Based RabbitCore Modules



Adapter Board for Rabbit 3000 Based RabbitCore Modules

ADAPTER BOARDS USE

Rabbit Semiconductor offer two Adapter Boards to allow you to use Rabbit Semiconductor's RabbitCore modules and single-board computers on a prototyping or development board whose prototyping area has a 0.1" pitch. One Adapter Board is designed for Rabbit 2000 based RabbitCore modules whose headers have a 2 mm pitch and the other Adapter Board is designed for Rabbit 3000 based RabbitCore modules whose headers have a 2 mm or 1.27 pitch.

The Adapter Boards are sold in panels of five, and headers and sockets are sold in quantities of five pairs. Simply choose, then install the headers and sockets you need for your particular application based on the illustrations in this manual. The illustrations indicate the part numbers of the headers and sockets appropriate for the illustrated board.

The Adapter Boards are also supplied in a "convenience pack," which includes one Adapter Board together with all the headers and sockets that might be used with that board.

Adapter Boards, convenience packs, and headers and sockets are available for purchase online at <http://www.rabbitsemiconductor.com/products/parts/index.html>.

A convenient small prototyping area will often be left on the Adapter Board once your Rabbit Semiconductor single-board computer or RabbitCore module is in place on the Adapter Board.

RCM2000

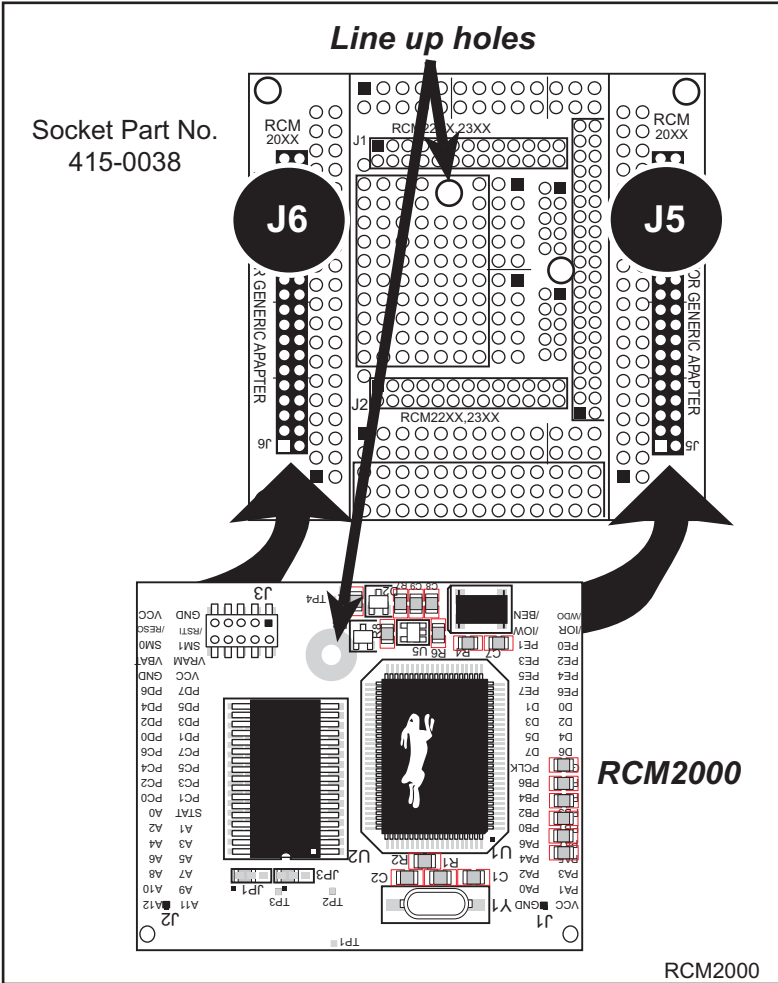

Figure 1. Top Side

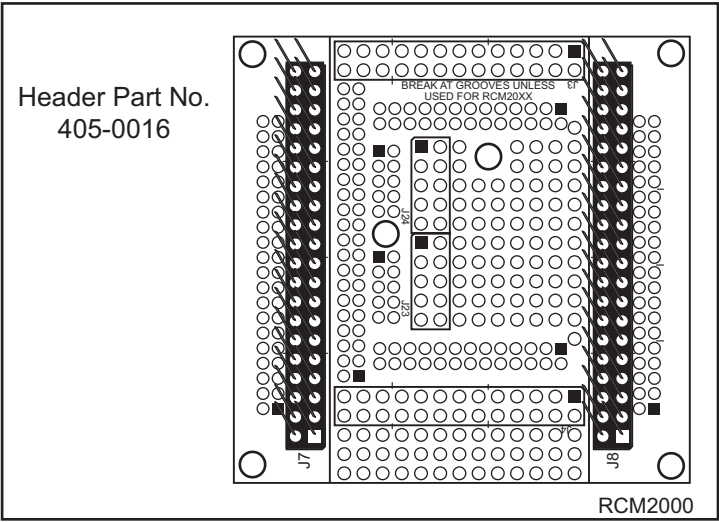

Figure 2. Bottom Side

RCM2100

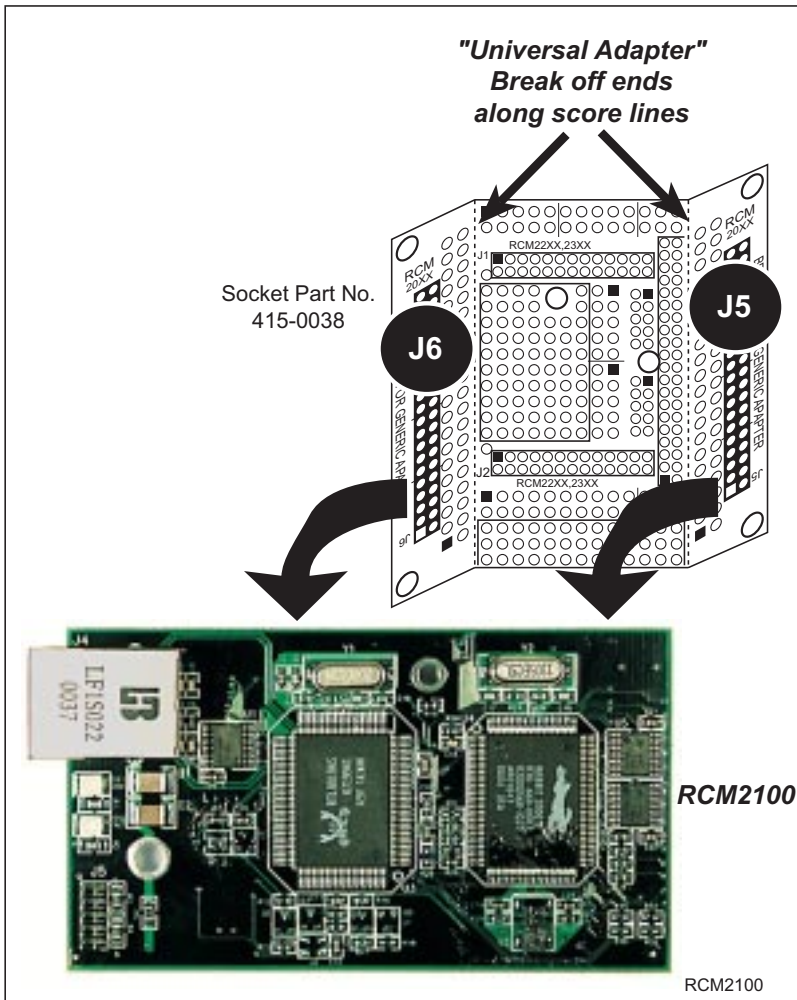

Figure 1. Top Side

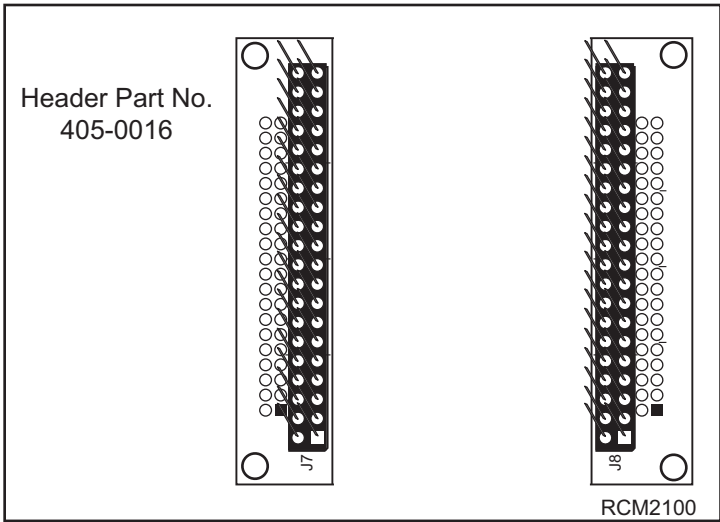

Figure 2. Bottom Side

RCM2200

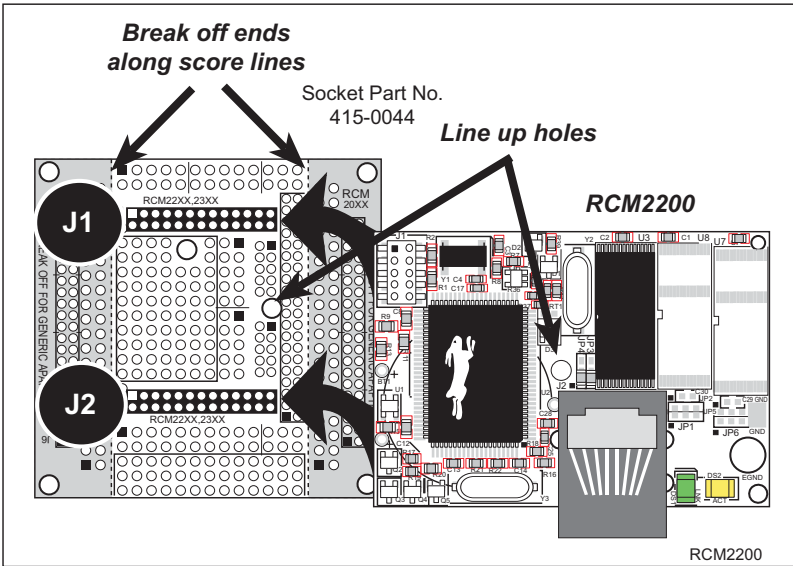

Figure 1. Top Side

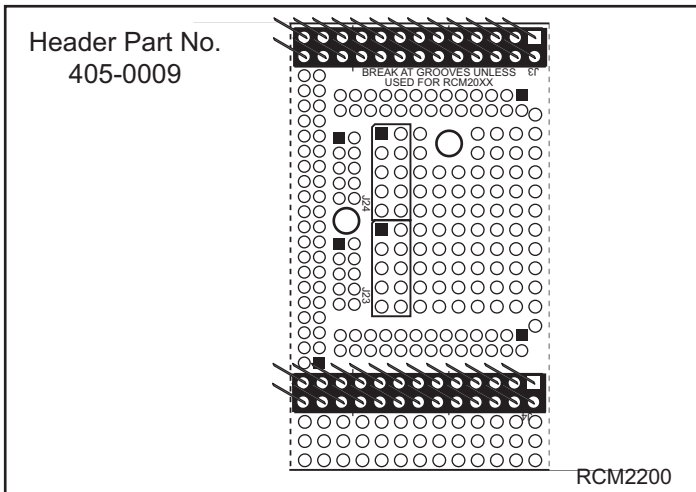

Figure 2. Bottom Side

RCM2300

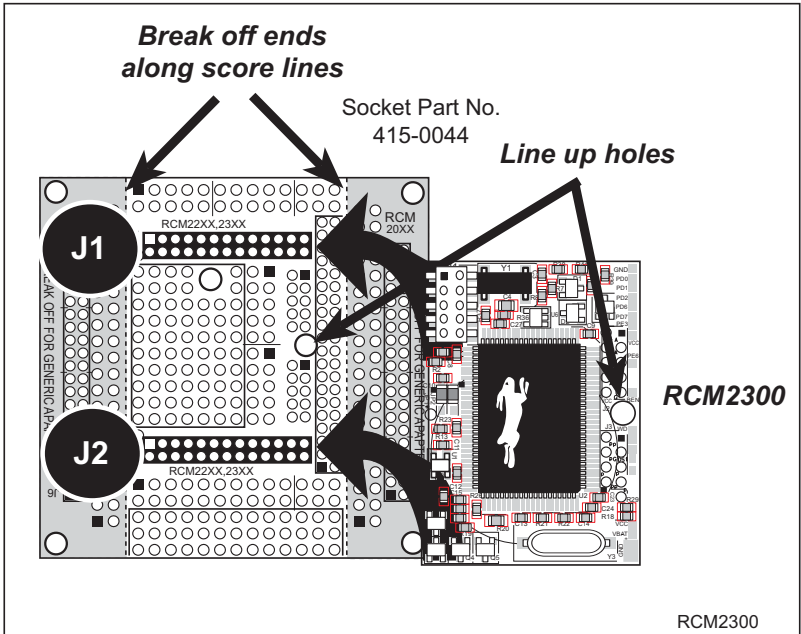

Figure 1. Top Side

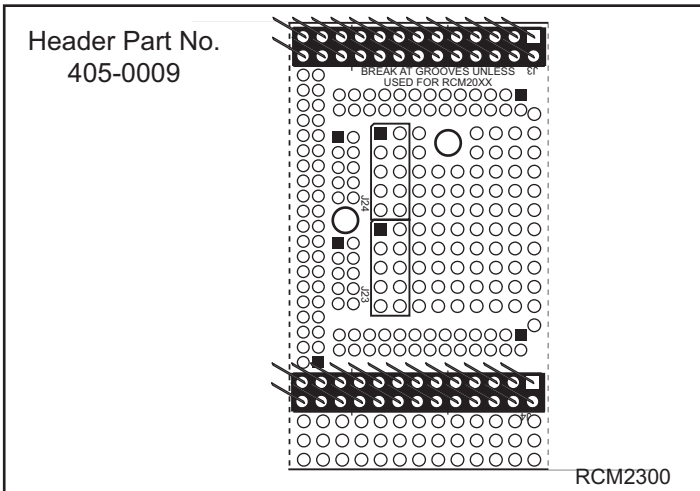

Figure 2. Bottom Side

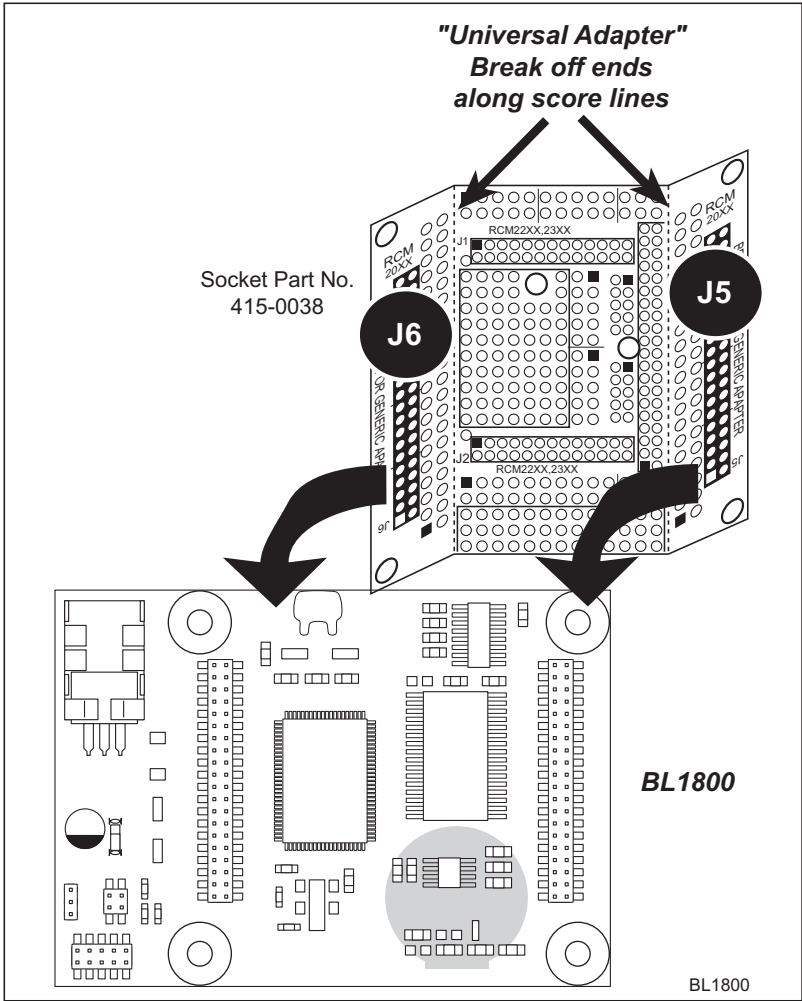

Figure 1. Top Side

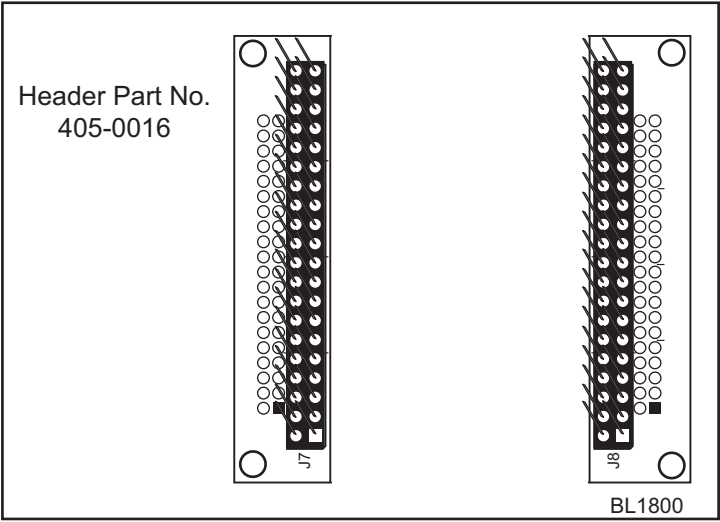

Figure 2. Bottom Side

Universal 2 mm to 0.1" Adapter

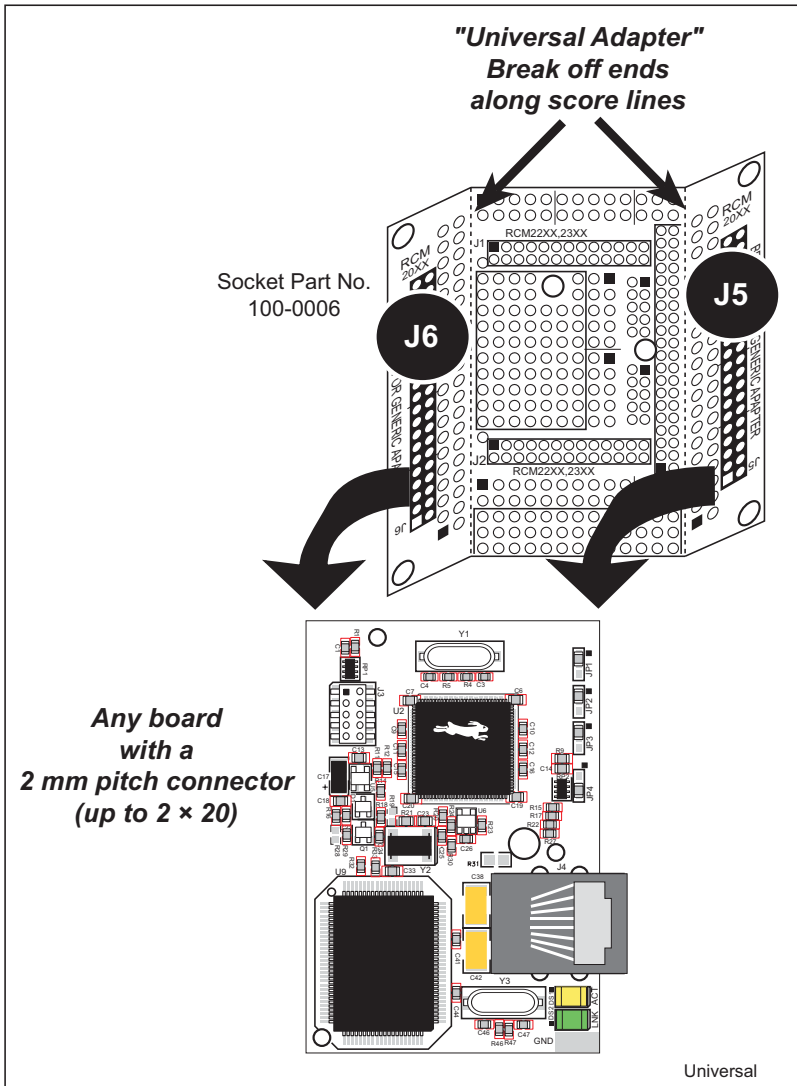

Figure 1. Top Side

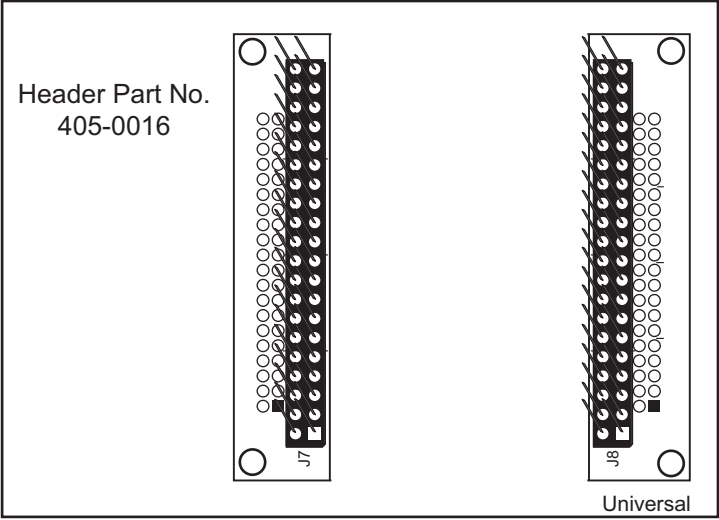

Figure 2. Bottom Side

RCM3000/RCM3100/RCM3200

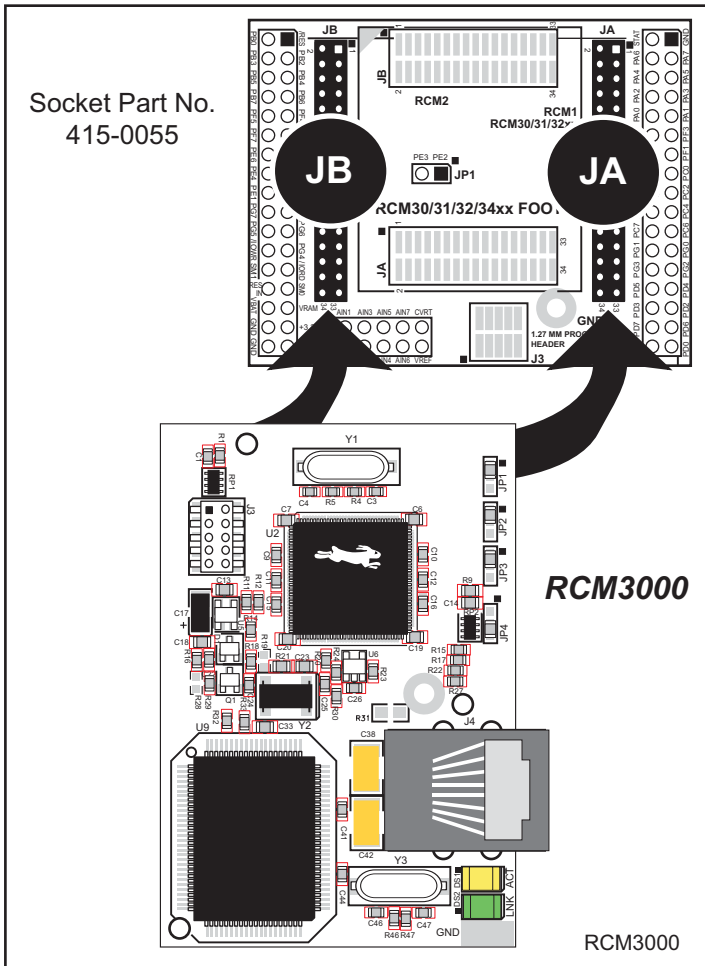

Figure 1. Top Side

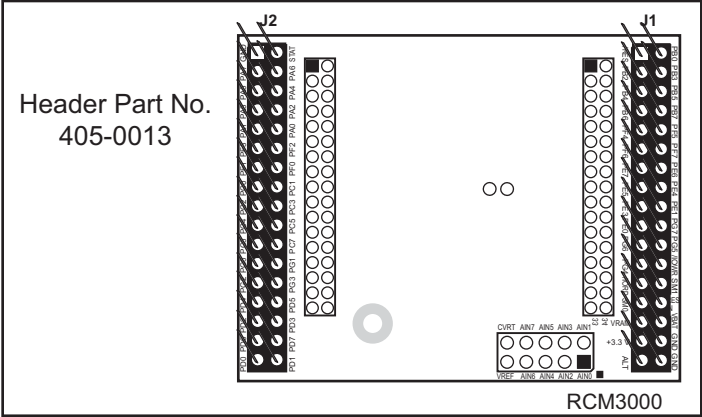

Figure 2. Bottom Side

RCM3400

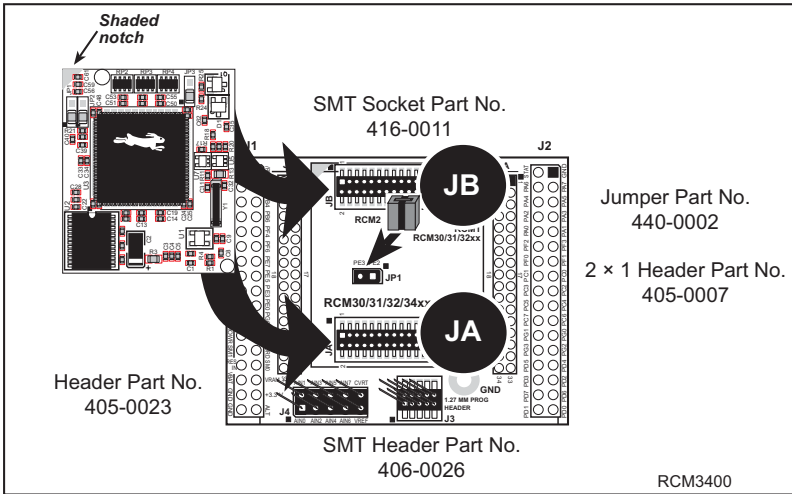

Figure 1. Top Side



Add a jumper as indicated on header JP1 to bring signal PE2 from the RCM3400 to pin 17 on header J1, which is labeled as PE3 for signals from the RCM3000/RCM3100/RCM3200 RabbitCore modules.

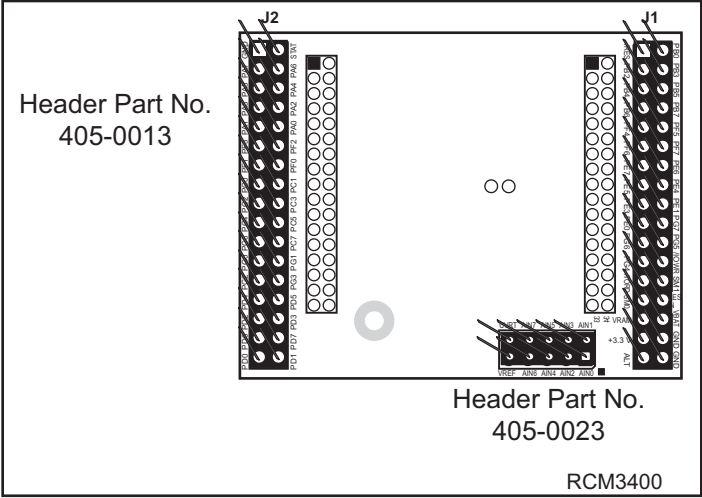

Figure 2. Bottom Side

APPENDIX. SPECIFICATIONS

Mechanical Specifications

Figure A-1 and Figure A-2 show the mechanical dimensions of the Adapter Boards.

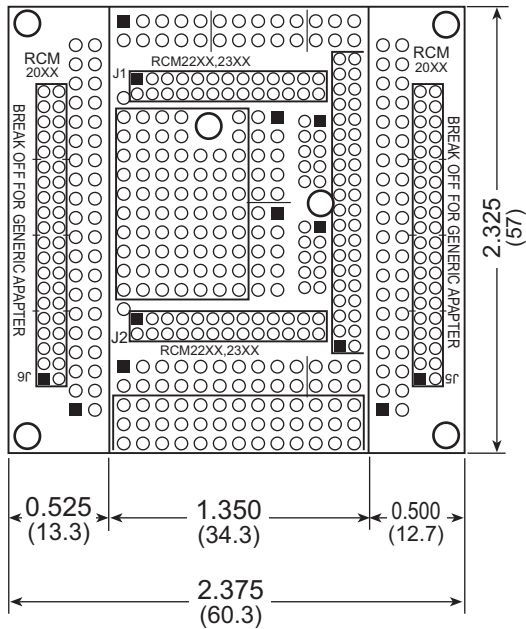

Figure A-1. RCM2000 Series Adapter Board Dimensions

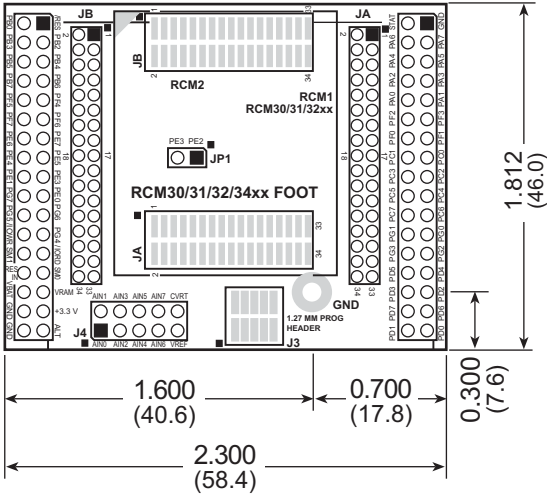

Figure A-2. RCM3000 Series Adapter Board Dimensions



SCHEMATICS

090-0165 RCM2000 Series Adapter Board Schematic

www.rabbit.com/documentation/schemat/090-0165.pdf

090-0171 RCM3000 Series Adapter Board Schematic

www.rabbit.com/documentation/schemat/090-0171.pdf

You may use the URL information provided above to access the latest schematics directly.

REVISION HISTORY		REVISION APPROVAL		
REV	E CO	ENGINEER	APPROVAL DATE	APPROVAL CONTROL
A	E12929	INITIAL RELEASE	8/7/02	KLS 8/7/02

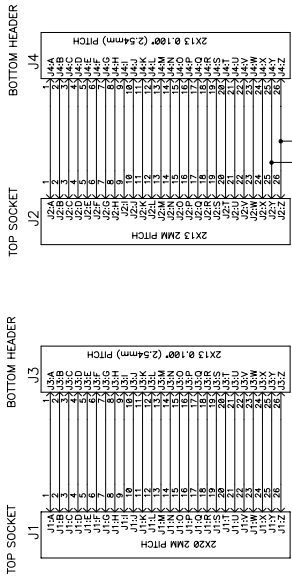

CONNECTED TO
PROTOTYPING AREA
FOR RM2224V/230X
POWER

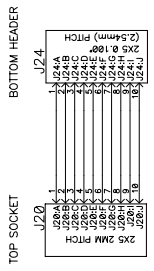
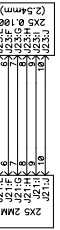
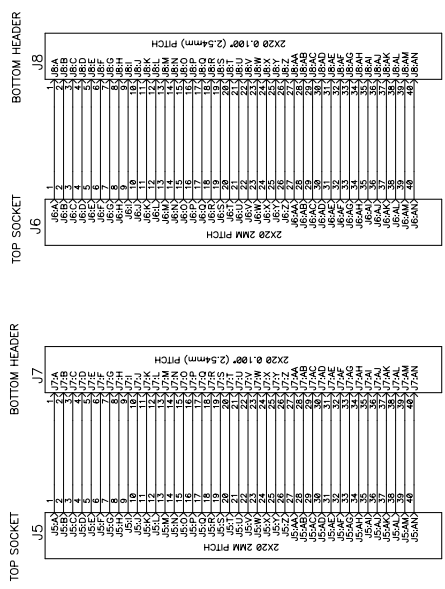

APPEND THE FOLLOWING DOCUMENTS WHEN CHANGING THIS DOCUMENT:		DRAWING CONTENT:		TITLE
		DRAWN BY: (INITIAL RELEASE)		ADAPTER BOARD SCHEMATIC
		REVISED BY:	08/06/02	
		APPROVALS: INITIAL RELEASE		
		PROJECT ENGINEER:	8/7/02	
		R. HESS		
		ENGINEERING MANAGER:	8/7/02	
		R. MATTHEWS		
		SIGNATURES	DATE	SCALE



2900 SHELFBORO ST.
MILWAUKEE, WI 5316-257-4616

ADAPTER BOARD SCHEMATIC

DWG NO. **090-0165**

SIZE **B**

REVISION HISTORY		REVISION APPROVAL	
REV	RCO	DESCRIPTION	APPROVAL DATE
A	E12117	INITIAL RELEASE	11/7/82

REVISION HISTORY	APPROVAL DATE	APPROVAL CONTROL	APPROVAL DATE
PROJECT ENGINEER	OF	11/7/82	MS

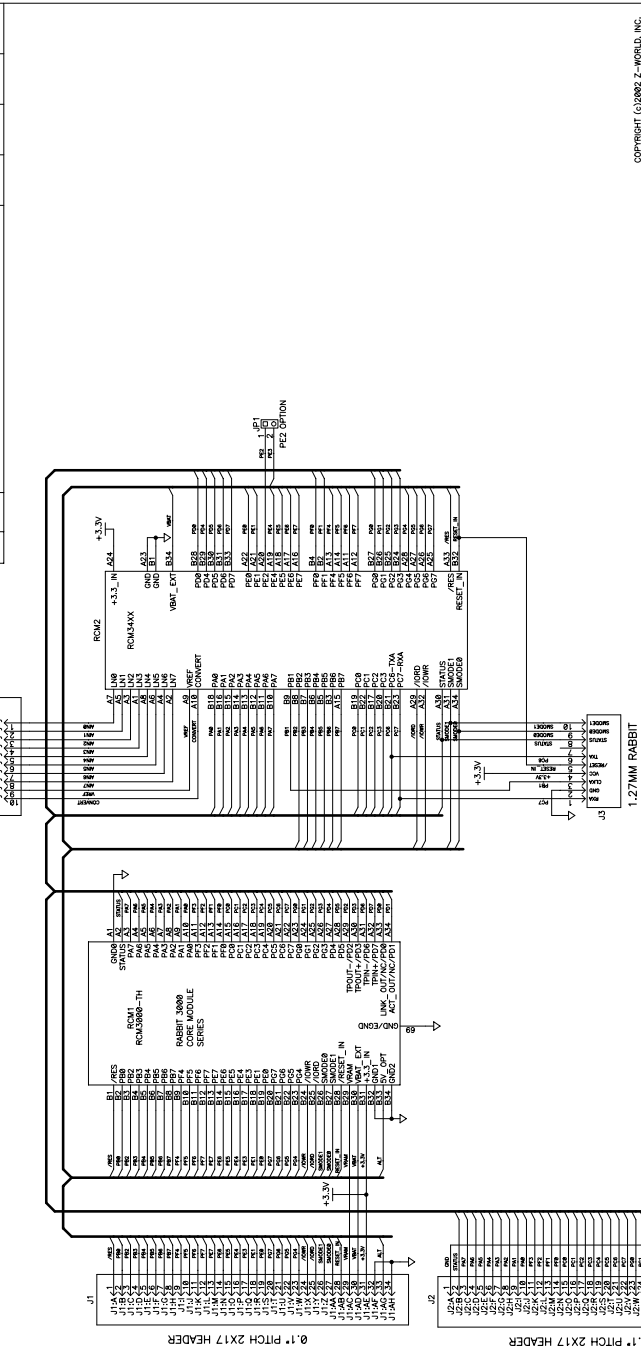

COPYRIGHT © 1982 Z-WORLD, INC.		TITLE	
DRAWING CONTENT:		11/7/82	
APPROVED THE FOLLOWING DOCUMENTS WHEN CHANGING THIS DOCUMENT:		DRAWN BY (CIRCUIT RELEASE)	
REVISED BY:		O-FOLLAND	
APPROVALS: INITIAL RELEASE		PROJECT ENGINEER:	
O-FOLLAND		O-FOLLAND	
11/7/82		11/7/82	
11/19/82		11/19/82	
DATE		DATE	
SIGNATURES		SIGNATURES	
SCALE		SCALE	
NONE		NONE	
RELEASE DATE		RELEASE DATE	
090-0171		090-0171	
SHEET 1 OF 1		SHEET 1 OF 1	

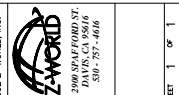

SCHEMATIC
RCM30/31/32/34XX
ADAPTER BOARD

2900 SFA FORD ST.
 DAVIS, CA 95616
 507-757-4616

X-ON Electronics

Largest Supplier of Electrical and Electronic Components

Click to view similar products for [Digi International](#) manufacturer:

Other Similar products are found below :

[WR31-L12A-DE1-TB](#) [XBP24-DMSIT-250](#) [CTANK-A611](#) [70001634](#) [70002412](#) [20-101-0444](#) [JD2D3-CDS-6F](#) [301-9004-01](#) [20-101-0654](#)
[CPTS-4R4E-R](#) [JR4N1-CL1-6F](#) [WR21-L82B-DE1-SB](#) [WR41-U900-NE1-SW](#) [WR44-0000-FE2-SW](#) [WR44-U900-FE2-SW](#) [X4-M11-E-A](#)
[XBP24BZ7PITB003J](#) [XBP24BZ7WITB003J](#) [XBP24-Z7WIT-004J](#) [XEB09-CIPAF](#) [XM-C91-4P-U](#) [XM-P91-2P-U](#) [XM-P91-UP-AA](#) [CC-](#)
[ACC-DB9C](#) [CC-WMX-MB47-VM](#) [70001953](#) [70002324](#) [76000873](#) [XBP24-ASI-080](#) [X2E-Z1R-E1-A](#) [WR44-L5F1-NE1-RF](#) [JM2T1-CL0-9I](#)
[CSENSE-A300](#) [20-101-1253](#) [20-101-0536](#) [CC-WMX6UL-START](#) [CC-MX-LB6B-ZM](#) [CC-WMX51-CE](#) [CC-MX-LD6A-ZM](#) [20-101-1068](#)
[101-1326](#) [70001931](#) [70001932](#) [301-2000-10](#) [DC-ES-4SB-EU](#) [76000896](#) [76000916](#) [DC-WME-9210-LX](#) [DC-ME-Y402-JT](#) [XM-M92-4P-U](#)