

USB-200 Series

12-Bit Multifunction DAQ Devices

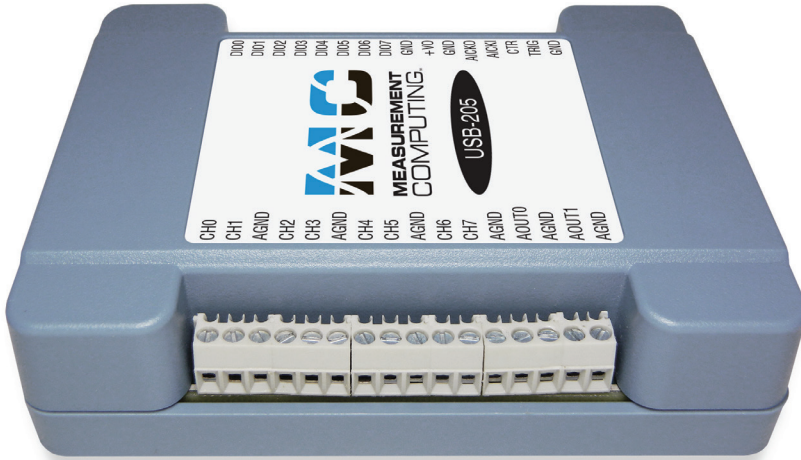

The USB-205 (shown above) provides eight SE analog inputs, two analog outputs, a maximum sample rate of 500 kS/s, 8 digital I/O, and one event counter input.

Features

- Eight 12-bit analog inputs
- Sample rates up to 500 kS/s
- Up to two analog outputs
- Eight digital I/O lines
- One 32-bit event counter input
- External pacer I/O
- No external power required
- Available with enclosure and screw terminals or as board-only OEM with header connectors
- ACC-205 DIN-rail kit available

Supported Operating Systems

- Windows® 10/8/7/Vista®XP 32/64-bit
- Linux®
- Android™

Overview

The USB-200 Series provides improved cost/performance compared to our similarly priced 12-bit DAQ devices. Each device provides eight single-ended (SE) analog inputs, eight DIO channels, one event counter, and external pacer I/O.

The USB-202 and USB-205 also provide two analog output channels.

Analog Input

USB-200 Series devices provide eight 12-bit SE analog inputs. The analog input range is fixed at ± 10 V.

Sample Rate

The maximum continuous scan rate is an aggregate rate. The following table lists the maximum rate per channel when scanning from one to eight channels.

Max Rate Per Channel (kS/s)*		
No. of Channels	USB-201, USB-202	USB-204, USB-205
1	100	500
2	50	250
3	33.33	166.67
4	25	125
5	20	100
6	16.67	83.33
7	14.29	71.43
8	12.50	62.50

* Sample rates apply to standard and OEM versions

Analog Output (USB-202 and USB-205)

The USB-202 and USB-205 standard and OEM versions have two 12-bit analog output channels. Both outputs can be updated simultaneously at a rate up to 125 S/s per channel. One output can be updated at a rate up to 250 S/s. The output range is fixed at 0 V to 5 V.

External Pacer I/O

Each USB-200 Series device provides one external clock input and one clock output for the analog input pacer. You can connect an external clock signal to the external clock input terminal. When using the internal clock, each device outputs the ADC sample clock.

USB-200 Series Selection Chart				
Model	Analog Input 12-bit	Max Sample Rate	Analog Output	Digital Output Current per pin
USB-201	8 SE	100 kS/s	–	± 24 mA
USB-202	8 SE	100 kS/s	2	± 24 mA
USB-204	8 SE	500 kS/s	–	± 24 mA
USB-205	8 SE	500 kS/s	2	± 24 mA
USB-201-OEM	8 SE	100 kS/s	–	± 24 mA
USB-202-OEM	8 SE	100 kS/s	2	± 24 mA
USB-204-OEM	8 SE	500 kS/s	–	± 24 mA
USB-205-OEM	8 SE	500 kS/s	2	± 24 mA

USB-200 Series

Features

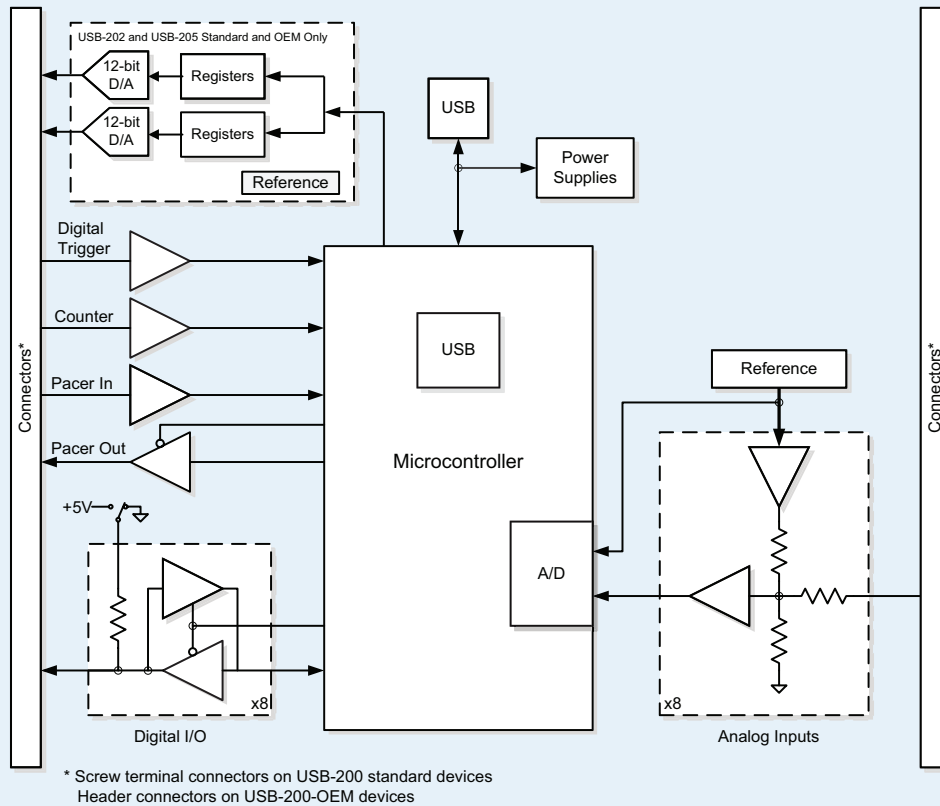

Digital I/O

USB-200 Series devices provide eight TTL-level digital I/O lines. Each digital channel is software-selectable for input or output. When configured for input, you can use the digital I/O terminals to detect the state of any TTL-level input.

When configured for output, each digital channel can source/sink up to ± 24 mA.

Pull-Up/Pull-Down Configuration

Each USB-200 Series device has a user-configurable internal jumper to configure the digital bits for pull-up or pull-down (default).

Counter Input

Each USB-200 Series device supports one 32-bit TTL-level event counter that accepts inputs up to 1 MHz.

Calibration

The USB-200 Series is factory-calibrated using a NIST-traceable calibration process. Specifications are guaranteed for one year. For calibration beyond one year, return the device to the factory for recalibration.

USB-200 Series OEM Versions

OEM versions have board-only form factors with header connectors for OEM and embedded applications. All devices can be further customized to meet customer needs.

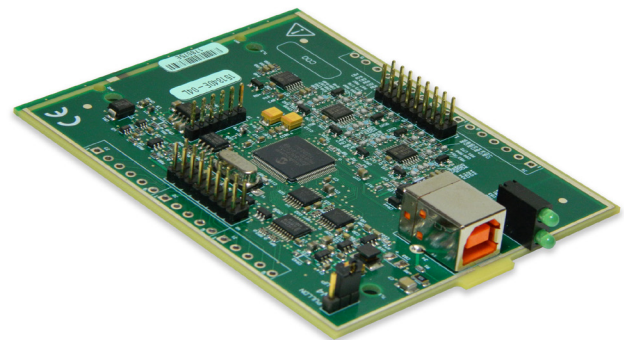

The OEM versions have the same specifications as the standard devices, but come in a board-only form factor with header connectors instead of screw terminals.







USB-200 Series

Software

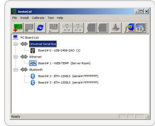

Software Support

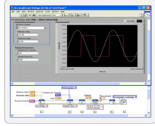
USB-200 Series devices are supported by the software in the table below.

Ready-to-Run Applications	
DAQami™ 	Data acquisition companion software with drag-and-drop interface that is used to acquire, view, and log data, and generate signals. DAQami can be configured to log analog, digital, and counter channels, and to view that data in real-time or post-acquisition on user-configurable displays. Logged data can be exported for use in Excel® or MATLAB®. Windows OS DAQami is included with the free MCC DAQ Software bundle. Install DAQami and try the fully-functional software for 30 days. After 30 days, all features except for data logging and data export will continue to be available – data logging and data export features can be unlocked by purchasing the software.
InstaCal™ 	An interactive installation, configuration, and test utility for MCC hardware. Windows OS InstaCal is included with the free MCC DAQ Software bundle.
TracerDAQ™ and TracerDAQ Pro 	Virtual strip chart, oscilloscope, function generator, and rate generator applications used to generate, acquire, analyze, display, and export data. Supported features may vary by hardware. The Pro version provides enhanced features. Windows OS TracerDAQ is included with the free MCC DAQ Software bundle. TracerDAQ Pro is available as a purchased software download.
General-Purpose Programming Support	
Universal Library™ (UL) for Windows 	Library for developing applications in C, C++, VB, C# .Net, VB .Net, and Python on Windows. The UL for Windows is included with the free MCC DAQ Software bundle. The UL Python API for Windows is available on GitHub (https://github.com/mccdaq/mcculw).
UL for Linux® 	Library for developing applications in C, C++, and Python on Linux. UL for Linux is available on GitHub (https://github.com/mccdaq/uldaq). Open-source, third-party Linux drivers are also available for supported MCC devices.
UL for Android™ 	Library of Java classes for programmers who develop apps for Android-based mobile devices. UL for Android communicates with select MCC DAQ devices. Supports Android project development on Windows, Linux, Mac OS X. UL for Android is included with the free MCC DAQ Software bundle.
Application-Specific Programming Support	
ULx for NI LabVIEW™ 	A comprehensive library of VIs and example programs for NI LabVIEW that is used to develop custom applications that interact with most MCC devices. Windows OS ULx for NI LabVIEW is included with the free MCC DAQ Software bundle.
DASYLab® 	Icon-based data acquisition, graphics, control, and analysis software that allows users to create complex applications in minimal time without text-based programming. Windows OS DASYLab is available as a purchased software download. An evaluation version is available for 28 days.
MATLAB® driver (USB-201/USB-204 standard and OEM)) 	High-level language and interactive environment for numerical computation, visualization, and programming. The Mathworks Data Acquisition Toolbox™ allows users to acquire data from most MCC PCI and USB devices. Visit www.MathWorks.com for more information about the Data Acquisition Toolbox.

USB-200 Series

Specifications



Specifications

All specifications are subject to change without notice.
Typical for 25 °C unless otherwise specified.
These specifications apply to both standard and OEM versions unless otherwise specified.

Analog Input

A/D converter type: Successive approximation
ADC resolution: 12 bits
Number of channels: 8 SE
Input voltage range: ± 10 V max
Absolute maximum input voltage
CHx to GND: ± 25 V max (power on or power off)
Input impedance: 1 M Ω (power on or power off)
Input bias current
10 V input: -12 μ A
0 V input: 2 μ A
-10 V input: 12 μ A

Input bandwidth, small signal (-3 dB)

USB-201/202: 150 kHz
USB-204/205: 1.0 MHz

Maximum working voltage

Input range relative to AGND: ± 10.1 V max

Crosstalk (adjacent channels, DC to 10 kHz): -75 dB

Input coupling: DC

Sample rate

Internal pacer

USB-201/202: 0.016 S/s to 100 kS/s, software-selectable
USB-204/205: 0.016 S/s to 500 kS/s, software-selectable

External pacer

USB-201/202: 100 kS/s max
USB-204/205: 500 kS/s max

Sample clock source

Internal A/D clock
Pacer input terminal AICKI

Channel queue: Up to eight unique, ascending channels

Throughput

Software paced: 33 S/s to 4000 S/s typ, system dependent

Hardware paced

USB-201/202: 100 kS/s max, system dependent
USB-204/205: 500 kS/s max, system dependent

Warm-up time: 15 minutes min

Accuracy

Analog Input DC Voltage Measurement Accuracy

Range: ± 10 V

Gain error (% of reading): 0.098

Offset error: 11 mV

Absolute accuracy at full scale: 20.8 mV

Gain temperature coefficient(% reading/°C): 0.016

Offset temperature coefficient (mV/°C): 0.87

Noise Performance

For peak to peak noise distribution, the input channel is connected to AGND at the input terminal block, and 12,000 samples are acquired at the maximum throughput.

Range: ± 10 V

Counts: 5

LSB_{rms}: 0.76

Analog Input Calibration

Recommended warm-up time: 15 minutes min

Calibration method: Factory

Calibration interval: 1 year

Analog Output (USB-202, USB-205 only)

Resolution: 12 bits, 1 in 4,096

Output range: 0 V to 5.0 V

Number of channels: 2

Throughput, software paced: 250 S/s single channel typ, PC dependent
Maximum throughput when scanning is machine dependent.

Power on and reset voltage, initializes to 000h code: 0 V, ± 10 mV

Output drive, each D/A OUT: 5 mA, sourcing

Slew rate: 0.8 V/ μ s typ

Analog Output Accuracy

All values are (\pm); accuracy tested at no load.

Range: 0 V to 5.0 V

Accuracy (LSB): 5.0 typ, 45.0 max

Analog Output Accuracy Components

All values are (\pm)

Range: 0 V to 5.0 V

% of FSR: 0.08 typ, 0.72 max

Gain error at FS (mV): 4.0 typ, 36.0 max

Offset (mV): 1.0 typ, 9.0 max

Zero-scale offsets may result in a fixed zero-scale error producing a “dead-band” digital input code region. Changes in digital input code at values less than 0x040 may not produce a corresponding change in the output voltage. The offset error is tested and specified at code 0x040.

Accuracy at FS (mV): 5.0 typ, 45.0 max

Digital I/O

Digital type: TTL

Number of I/O: 8

Configuration: Each bit may be configured as input (power on default) or output

Pull-up configuration: The port has 47 k Ω resistors that may be configured as pull-up or pull-down with an internal jumper. The factory configuration is pull-down.

Digital I/O transfer rate (system-paced): 33 to 4000 port reads/writes per second typical, system dependent

Input low voltage threshold: 0.8 V max

Input high voltage threshold: 2.0 V min

Input voltage limits: 5.5 V absolute max, -0.5 V absolute min, 0 V recommended min

Output high voltage: 4.4 V min (IOH = -50 μ A), 3.76 V min (IOH = -24 mA)

Output low voltage: 0.1 V max (IOL = 50 μ A), 0.44 V max (IOL = 24 mA)

Output current: ± 24 mA max

External Digital Trigger

Trigger source: TRIG input

Trigger mode: Software-selectable for edge or level sensitive, rising or falling edge, high or low level. Power on default is edge sensitive, rising edge.

Trigger latency: 1 μ s + 1 pacer clock cycle max

Trigger pulse width: 125 ns min

Input type: Schmitt trigger, 47 k Ω pull-down to ground

Schmitt trigger hysteresis: 1.01 V typ, 0.6 V min, 1.5 V max

Input high voltage threshold: 2.43 V typ, 1.9 V min, 3.1 V max

Input low voltage threshold: 1.42 V typ, 1.0 V min, 2.0 V max

Input voltage limits: 5.5 V absolute max, -0.5 V absolute min, 0 V recommended min

External Pacer Input/Output

Terminal names: AICKI, AICKO

Terminal types

AICKI: Input, active on rising edge

AICKO: Output, power on default is 0 V, active on rising edge

Terminal descriptions

AICKI: Receives pacer clock from external source

AICKO: Outputs internal pacer clock

Input clock rate

USB-201/202: 100 kHz max

USB-204/205: 500 kHz max

Clock pulse width

AICKI: 400 ns min

AICKO: 400 ns min

Input type: Schmitt trigger, 47 k Ω pull-down to ground

Schmitt trigger hysteresis: 1.01 V typ, 0.6 V min, 1.5 V max

Input high voltage threshold: 2.43 V typ, 1.9 V min, 3.1 V max

Input low voltage threshold: 1.42 V typ, 1.0 V min, 2.0 V max

Input voltage limits: 5.5 V absolute max, -0.5 V absolute min, 0 V recommended min

Output high voltage: 4.4 V min (IOH = -50 μ A), 3.80 V min (IOH = -8 mA)

Output low voltage: 0.1 V max (IOL = 50 μ A), 0.44 V max (IOL = 8 mA)

Output current: ± 8 mA max

USB-200 Series

Specifications and Ordering



Counter

Pin name: CTR
Counter type: Event counter
Number of channels: 1
Input type: Schmitt trigger, 47 k Ω pull-down to ground
Input source: CTR screw terminal
Resolution: 32 bits
Maximum input frequency: 1 MHz
Counter read/write rates (software paced): 33 to 4,000 reads/writes per second
typ, system dependent
High pulse width: 25 ns min
Low pulse width: 25 ns min
Schmitt trigger hysteresis: 1.01 V typ, 0.6 V min, 1.5 V max
Input high voltage threshold: 2.43 V typ, 1.9 V min, 3.1 V max
Input high voltage limit: 5.5 V absolute max
Input low voltage threshold: 1.42 V typ, 1.0 V min, 2.0 V max
Input low voltage limit: -0.5 V absolute min, 0 V recommended min

Memory

Data FIFO: 12 K (12,288) analog input samples
Non-volatile memory: 2 KB (768 B calibration storage, 256 B UL user data, 1 KB system data)

Power

Supply current: 150 mA typ, 500 mA max (including user voltage, DIO and AICKO loading)
Total quiescent current requirement for the device, which includes up to 10 mA for the Status LED. This value does not include any potential loading of the digital I/O bits, AICKO, or user voltage.
User voltage output terminal (+VO): 4.5 V min, 5.25 V max
User voltage output current: 100 mA max

Environment

Operating temperature:
All USB-200 Series devices except the USB-201-OEM: 0 °C to 55 °C
USB-201-OEM: -40 °C to 85 °C max
Storage temperature: -40 °C to 85 °C max
Relative humidity: 0% to 90% non-condensing

Mechanical

Signal I/O connector
Standard versions: Two banks of screw-terminal blocks
OEM versions: Two 2 × 8 0.1 in. pitch headers, labeled W1 and W3
Dimensions (L × W × H)
Standard versions: 117.86 × 82.80 × 28.96 mm (4.64 × 3.26 × 1.14 in.) max
OEM versions: 98.30 × 76.71 × 14.61 mm (3.87 × 3.02 × 0.575 in.) max

Order Information

Hardware

Part No.	Description
USB-201	USB-based DAQ device with eight 12-bit analog inputs, 100 kS/s sampling, and 8 digital I/O lines; includes USB cable and MCC DAQ software
USB-202	USB-based DAQ device with eight 12-bit analog inputs, 100 kS/s sampling, two 12-bit analog outputs, and 8 digital I/O lines; includes USB cable and MCC DAQ software
USB-204	USB-based DAQ device with eight 12-bit analog inputs, 500 kS/s sampling, and 8 digital I/O lines; includes USB cable and MCC DAQ software
USB-205	USB-based DAQ device with eight 12-bit analog inputs, 500 kS/s sampling, two 12-bit analog outputs, and 8 digital I/O lines; includes USB cable and MCC DAQ software
USB-201-OEM	Board-only USB-based DAQ device with eight 12-bit analog inputs, 100 kS/s sampling, and 8 digital I/O lines
USB-202-OEM	Board-only USB-based DAQ device with eight 12-bit analog inputs, 100 kS/s sampling, two 12-bit analog outputs, and 8 digital I/O lines
USB-204-OEM	Board-only USB-based DAQ device with eight 12-bit analog inputs, 500 kS/s sampling, and 8 digital I/O lines
USB-205-OEM	Board-only USB-based DAQ device with eight 12-bit analog inputs, 500 kS/s sampling, two 12-bit analog outputs, and 8 digital I/O lines

Accessories

Part No.	Description
ACC-205	DIN-rail kit; standard devices only

Software also Available from MCC

Part No.	Description
DAQami	Data acquisition companion software for acquiring data and generating signals
TracerDAQ Pro	Out-of-the-box virtual instrument suite with strip chart, oscilloscope, function generator, and rate generator – professional version
DASYLab	Icon-based data acquisition, graphics, control, and analysis software

X-ON Electronics

Largest Supplier of Electrical and Electronic Components

Click to view similar products for [Development Boards & Kits - ARM category](#):

Click to view products by [Digilent manufacturer](#):

Other Similar products are found below :

[SAFETI-HSK-RM48](#) [CC-ACC-MMK-2443](#) [TWR-MC-FRDMKE02Z](#) [EVALSPEAR320CPU](#) [EVB-SCMIMX6SX](#) [MAX32600-KIT#](#)
[TMDX570LS04HDK](#) [TXSD-SV70](#) [OM13080UL](#) [EVAL-ADUC7120QSPZ](#) [OM13082UL](#) [TXSD-SV71](#) [YGRPEACHNORMAL](#)
[OM13076UL](#) [PICODWARFFL](#) [YR8A77450HA02BG](#) [3580](#) [32F3348DISCOVERY](#) [PIC16F15376](#) [CURIOSITY NANO BOARD](#)
[PIC18F47Q10](#) [CURIOSITY NANO](#) [EVAL-ADUCM355EMCZ](#) [80-001428](#) [EAK00360](#) [YR0K77210B000BE](#) [RTK7EKA2L1S00001BE](#)
[MAX32651-EVKIT#](#) [SLN-VIZN-IOT](#) [ALLTHINGSTALK](#) [LTE-M RAPID DEV. KIT](#) [ESP32-POE-ISO-EA-IND](#) [ESP32-POE-ISO-IND](#)
[T4WK-F01EU6](#) [LV18F V6 DEVELOPMENT SYSTEM](#) [READY FOR AVR BOARD](#) [READY FOR PIC BOARD](#) [READY FOR PIC \(DIP28\)](#)
[EVB-VF522R3](#) [AVRPLC16 V6 PLC SYSTEM](#) [MIKROLAB FOR AVR XL](#) [MIKROLAB FOR PIC L](#) [MINI-AT BOARD - 5V](#) [MINI-M4](#)
[FOR STELLARIS](#) [MOD-09.Z](#) [BUGGY + CLICKER 2 FOR PIC32MX + BLUETOOT](#) [1410](#) [LETS MAKE PROJECT PROGRAM. RELAY](#)
[PIC](#) [LETS MAKE - VOICE CONTROLLED LIGHTS](#) [LPC-H2294](#) [DSPIC-READY2 BOARD](#) [DSPIC-READY3 BOARD](#) [MIKROBOARD](#)
[FOR ARM 64-PIN](#)