

**PC, DVI INTERFACE CONTROLLER
FOR TFT PANEL**

Model: ALR-1400

Part number : 41710003X/4X-3 or up

INSTRUCTIONS

CONTENTS

Page: 2. **Introduction, How to Proceed, Usage Note, Disclaimer**
2. **System design** – Diagram of a suggested system
3. **Assembly notes** – Important information about system elements
5. **Connection & Operation** – How to use the controller
9. **Connectors, pinouts & jumpers** – Essential connection information
17. **Controller dimensions**
18. **Application notes**
20. **Troubleshooting**
21. **Specifications**
22. **Appendix I – Graphic Mode Support Table**
23. **Appendix II – RS-232 control protocols**
26. **Appendix III – Mapping definition**
28. **Appendix IV – Auto Color Gain**
29. **Warranty, Caution & Limitation of Liability, Trademarks**
30. **Contact details**

It is essential that these instructions are read and understood before connecting or powering up this controller.

Introduction

Designed for LCD monitor and other flat panel display applications, the ALR-1400 controller provides easy to use interface controller for:

- TFT (active matrix) LCDs with LVDS interface of 1366x768, 1280x1024, 1280x800, 1280x768, 1024x768, 1024x600, 800x600, 800x480, 640x480, 480x234 resolution;
- Computer video signals of SXGA, XGA, SVGA, VGA standard
- Support LVDS or TTL interface panel

HOW TO PROCEED

- Ensure you have all parts & that they are correct, refer to:
 - Connection diagram (separate document for each panel)
 - Connector reference (in following section)
 - Assembly notes
- Check controller switch & jumper settings (errors may damage the panel)
- Prepare the PC
- Connect the parts
- Understand the operation and functions (in following section)

IMPORTANT USAGE NOTE

This product is for use by system developers and integrators, the manufacturer accepts no liability for damage or injury caused by the use of this product. It is the responsibility of the developer, integrators or other user of this product to:

- Ensure that all necessary and appropriate safety measures are taken.
- Obtain suitable regulatory approvals as may be required.
- Check power settings to all component parts before connection.
- Understand the operation and connectivity requirements of this controller.

DISCLAIMER

There is no implied or expressed warranty regarding this material.

SYSTEM DESIGN

A typical LCD based display system utilising this controller is likely to comprise the following:

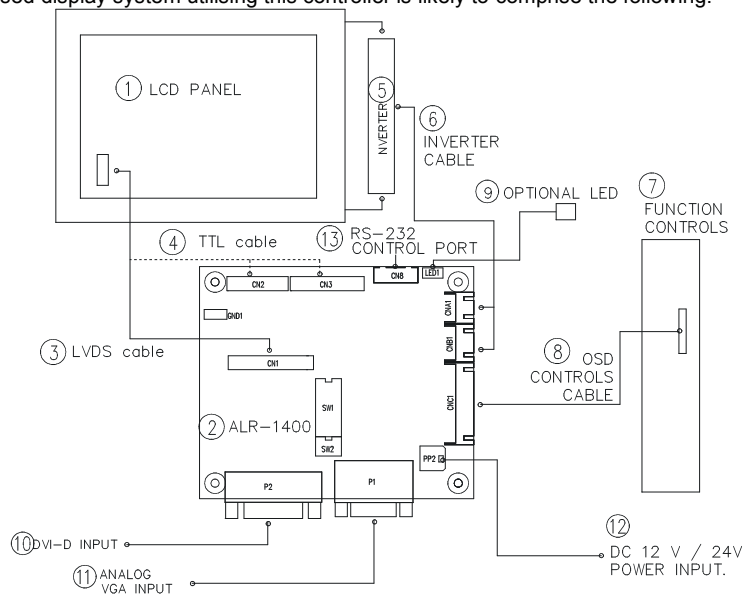

Summary:

1. LCD panel
2. LCD controller card, ALR-1400
3. LVDS cable (for connection with LVDS panel)
4. TTL cable (for connection with TTL panel)
5. Inverter for CCFT backlight (if not built into LCD)
6. Inverter cable
7. Function controls
8. Function controls cable
9. Status LED
10. DVI-D input
11. Analog VGA input
12. Power input (12VDC / 24VDC)
13. RS-232 control port

Digital View offers a range of accessories such as listed above, to make up complete display solution.

ASSEMBLY NOTES

This controller is designed for monitor and custom display projects using 1366 x 768, 1280 x 1024, 1280 x 800, 1280 x 768 or 1024 x 768, 1024 x 600, 800 x 600, 800 x 480, 640 x 480 or 480 x 234 resolution TFT panels with a VGA, SVGA, XGA, SXGA signal input. The following provides some guidelines for installation and preparation of a finished display solution.

Preparation: Before proceeding it is important to familiarize yourself with the parts making up the system and the various connectors, mounting holes and general layout of the controller. As much as possible connectors have been labeled. Guides to connectors and mounting holes are shown in the following relevant sections.

1. **LCD Panel:** This controller is designed for typical LVDS or TTL interface TFT panels with panel voltage 3.3V or 5V or 12V or 18V LVDS interface. Due to the variation between manufacturers of signal timing and other panel characteristics factory setup and confirmation should be obtained before connecting to a panel. **(NOTE: Check panel power jumper settings before connection)**
 2. **Controller card:** Handle the controller card with care as static charge may damage electronic components.
 3. **LVDS signal cable :** In order to provide a clean signal it is recommended that LVDS signal cables are no longer than 46cm (18 inches). If loose wire cabling is utilized these can be made into a harness with cable ties. Care should be taken when placing the cables to avoid signal interference. Additionally it may be necessary in some systems to add ferrite cores to the cables to minimize signal noise.
 4. **TTL signal cable:** In order to provide a clean signal it is recommended that LCD signal cables are no longer than 33cm (13 inches). If loose wire cabling is utilized these can be made into a harness with cable ties. Care should be taken when placing the cables to avoid signal interference. Additionally it may be necessary in some systems to add ferrite cores to the cables to minimize signal noise.
 5. **Inverter:** This will be required for the backlight of an LCD, some LCD panels have an inverter built in. As panels may have 1 or more backlight tubes and the power requirements for different panel models backlights may vary it is important to match the inverter in order to obtain optimum performance. See page 15 for the Application notes "Inverter connection section for more informations.
 6. **Inverter Cables:** Different inverter models require different cables and different pin assignment. Make sure correct cable pin out to match the inverter. Using wrong cable pin out may damage the inverter.
 7. **Function Controls:** The following section discusses the controls required and the section on connectors provides the detail. The controls are minimal: On/Off, Backlight Brightness (depends on inverter), OSD (5 momentary buttons) analog VR type or (8 momentary buttons) digital type.
 8. **Function controls cable:** The cables to the function switches should be of suitable quality and length so that impedance does not affect performance. Generally lengths up to 1 metre (3 feet) should be acceptable.
 9. **DVI-D Input Cable :** Plug the DVI cable to the connector P2 on the controller board
 10. **Analog VGA Input Cable:** As this may affect regulatory emission test results and the quality of the signal to the controller, a suitably shielded cable should be utilized.
- **Power Input:** 12V / 24V DC is required, this should be a regulated supply. Although the controller provides power regulation for the LCD power this does not relate to the power supplied to the backlight inverter. If an unregulated power supply is provided to an inverter any fluctuations in power may affect operation, performance and lifetime of the inverter and or backlight tubes.
24VDC input is required when the panel output voltage is 18VDC. Please refer to page 10-11 for proper jumper settings.
 - **Power Safety:** Note that although only 12VDC / 24VDC is supplied as 'power-in' a backlight inverter for panel backlighting produces significantly higher voltages (the inverter does not connect to the ground plane). We strongly advise appropriate insulation for all circuitry.
 - **EMI:** Shielding will be required for passing certain regulatory emissions tests. Also the choice of external Controller to PC signal cable can affect the result.
 - **Ground:** The various PCB mounting holes are connected to the ground plane.
 - **Servicing:** The board is not user serviceable or repairable. Warranty does not cover user error in connecting up to the controller and is invalidated by unauthorized modification or repairs.
 - **Controller Mounting:** It is recommended that a clearance of at least 10mm is provided above and 5mm below the controller when mounted. Additionally consideration should be given to:
 - Electrical insulation.
 - Grounding.
 - EMI shielding.
 - Cable management. Note: It is important to keep panel signal cables apart from the inverter & backlight cables to prevent signal interference.
 - Heat & Ventilation: Heat generated from other sources, for example the backlight of a very high brightness panel may generate significant heat which could adversely affect the controller.
 - Other issues that may affect safety or performance.

- **PC Graphics Output:** A few guidelines:
 - Signal quality is very important, if there is noise or instability in the PC graphics output this may result in visible noise on the display.
 - Refer to graphics modes table in specifications section for supported modes.
 - Non-interlaced & interlaced video input is acceptable.

IMPORTANT: Please read the Application Notes section for more information.

CONNECTION & OPERATION

CAUTION: Never connect or disconnect parts of the display system when the system is powered up as this may cause serious damage.

CONNECTION

Connection and usage is quite straight forward (it is useful to have the relevant connection diagram available at this time):

1. **LCD panel & Inverter:** Connect the inverter (if it is not built-in the panel) to the CCFT lead connector of the LCD panel.
2. **LVDS type panels:** Plug the LVDS signal cable direct to CN1 (if necessary). Insert the panel end of the cable to the LCD panel connector.
3. **TTL type panels:** Plug the signal cables direct to CN2 or CN3. Plug the other end of cables to the LCD connector board (if connector board is required, otherwise the signal can be direct plug to the LCD panel connector). Then plug the board connector to the LCD panel connector.
4. **Inverter & Controller:** Plug the inverter cable to CNB1 and CNA1 (if necessary). Plug another end to the connector on the inverter.
5. **Function switch & Controller:** Plug the OSD switch mount cable to CNC1 on the controller board and another to the OSD switch mount.
6. **LED & Controller:** Plug in a 3-way with dual colour LED to connector LED1 on the controller board.
7. **Jumpers :** Check all jumpers are set correctly. Details referring the connection diagram at <http://www.digitalview.com/controllers/csg.php>
8. **Jumpers & Inverter & Panel voltage:** Particularly pay attention to the settings of JA3, JA6, JB2, JB3. JB2 & JB3 are used for inverter control (read inverter specification and information on the jumper table to define the correct settings). JA3 & JA6 are used for panel voltage input (read panel specification and information on the jumper table to define the correct settings).
9. **DVI cable :** Plug the DVI cable to the connector P2 on the controller board.
10. **VGA cable & Controller:** Plug the VGA cable to the connector P1 on the controller board.
12. **Power supply & Controller:** Plug the DC 12V / 24V power in to the connector PP2. You can consider to use DigitalView mating power cable P/N 426013800-3, 160mm.
13. **Power on:** Switch on the controller board and panel by using the OSD switch mount.

CAUTION: Never connect or disconnect parts of the display system when the system is powered up as this may cause serious damage.

LED status :

State	LED color
No signal & backlight off	RED
No signal & backlight on	ORANGE
With signal & backlight on	GREEN

General:

- If you are using supplied cables & accessories, ensure they are correct for the model of panel and controller.
- If you are making your own cables & connectors refer carefully to both the panel & inverter specifications and the section in this manual, "Connectors, Pinouts & Jumpers" to ensure the correct pin to pin wiring.

PC SETTINGS

The controller has been designed to take a very wide range of input signals however to optimize the PC's graphics performance we recommend choosing 60Hz vertical refresh rate – this will not cause screen flicker.

OPERATION

Once the system has been connected and switched on there are a number of functions available to adjust the display image as summarized in the following sections. The settings chosen will be saved for each mode independently.

LCD DISPLAY SYSTEM SETTINGS

NOTE: By way of explanation the following refers to a set of sample buttons that may be obtained as an option. In addition to power on/off and connection for backlight brightness the controller provides an On Screen Display of certain functions which are controlled by 5 momentary type buttons (analog VR type) or 8 momentary type buttons (digital type):

Controls	Analog VR type	Digital type
On/Off – turns controller board power on	VR toggle switch	On/Off button
Brightness – controls backlight brightness	Rotary VR	Brightness +/- buttons
Menu – turns OSD menu On or Off (it will auto time off) (Function with signal input only)	Menu button	Menu button
Select – Select function / Confirm (under OSD menu on state)	SEL DN	SEL DN
Move up to select individual RGB color level OSD page (under OSD menu on state)	SEL UP	SEL UP
+ – increase the setting / moves the selector to the next function (under OSD menu on state)	+	+
- - decrease the setting / moves the selector to the previous function (under OSD menu on state)	-	-
Reset to Factory Defaults	Press and hold SEL DN button, then power on the controller	Press and hold SEL DN button, then power on the controller
Lock OSD menu (Function with signal input only)	Press and hold MENU button for 15 seconds to enable / disable lock of the OSD menu	Press and hold MENU button for 15 seconds to enable / disable lock of the OSD menu
Direct access key for Brightness level increase (under OSD menu off state)	+	+
Direct access key for Brightness level decrease (under OSD menu off state)	-	-

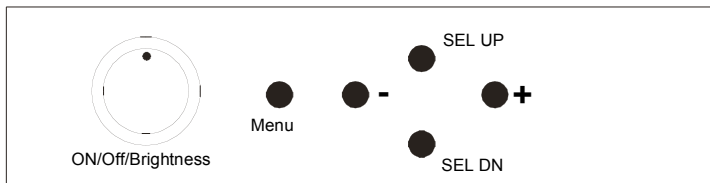

Analog VR type

12V / 24VDC power input :
Analog 10K VR Type OSD switch mount uses P/N 410680550-3 or up

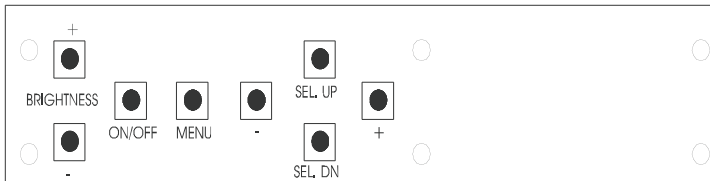





























Digital type



12V / 24VDC power input :
Digital 10K Type OSD switch mount uses P/N 416100520-3 or up

12VDC power input :
Digital 10K Type OSD switch mount uses P/N 416100510-3

OSD Functions

Select input source			
		Input source 1	Select input source to Analog RGB
		Input source 2	Select input source to DVI
		Auto Source Seek	ON – Auto source select always enable OFF – Disable auto source select function
		Wide screen mode information display*	Select the input mode (1280 / 1360 / 1366 / 1368) to recognize and display the correct input signal information display on the OSD menu. 1280 : 1280x768 1360 : 1360x768 1366 : 1366x768 1368 : 1368x768
		Exit	Exit the OSD menu and save the settings
Brightness and Contrast			
	Brightness	Increase/decrease brightness level. Press – or + (- +) Total : 256 steps	

		Contrast	Increase/decrease panel contrast level. Press – or + (- <input type="text"/> +) Total : 192 steps
		Exit	Exit the OSD menu and save the settings
Color			
		Auto RGB Calibration*	<input checked="" type="checkbox"/> Yes <input checked="" type="checkbox"/> No (Auto Color Calibration [See appendix IV])
		Color Temperature <input type="checkbox"/>	(Adjust the warmth of the image displayed. The higher temperature the coolest image looks like. The lower temperature the warmest image looks like.)
			Adjust red color level Press – or + (- <input type="text"/> +) Total :128 steps Adjust green color level Press – or + (- <input type="text"/> +) Total : 128 steps Adjust blue color level Press – or + (- <input type="text"/> +) Total : 128 steps Press SEL UP/DN button to select item
		4200K	Set the color temperature to 4200K
		5000K	Set the color temperature to 5000K
		6500K	Set the color temperature to 6500K
		7500K	Set the color temperature to 7500K
		9300K	Set the color temperature to 9300K
		Gamma adjustment <input type="checkbox"/>	Adjust Gamma settings (0.4 / 0.6 / 1.0 / 1.6 / 2.2)
		0.4	Select Gamma to 0.4
		0.6	Select Gamma to 0.6
		1.0	Select Gamma to 1.0
		1.6	Select Gamma to 1.6
		2.2	Select Gamma to 2.2
		Exit	Exit the OSD menu and save the settings
Position			
		Autosetup*	Auto adjust the positions, phase, frequency <input checked="" type="checkbox"/> Yes <input checked="" type="checkbox"/> No
		Frequency*	Adjust the image horizontal size
		Phase*	Fine tune the data sampling position (adjust image quality)
		Image Horizontal Position*	Use +/- to move the image horizontally Press – or + (- <input type="text"/> +)
		Image Vertical Position*	Use +/- to move the image vertically Press – or + (- <input type="text"/> +)
		Exit	Exit the OSD menu
Utilities			
		OSD setting <input type="checkbox"/>	
			OSD Timeout : 0 / 10 / 20 / 30 / 40 / 50 / 60 seconds (Always on when set to 0) Press – or + (- <input type="text"/> +)
			OSD menu horizontal position Press – or + (- <input type="text"/> +)
			OSD menu vertical position Press – or + (- <input type="text"/> +)
		Load Factory Default	Initialize the setting stored in non-volatile memory
		Sharpness	Adjust sharpness level Press – or + (- <input type="text"/> +) Total : 7 steps

		Exit	Exit the OSD menu
	Exit the OSD menu		

[Firmware version : V1.76 or up]

* Function in ARGB mode only

Items marked have sub menus.

Exit the OSD menu to save the setting chosen

CONNECTORS, PINOUTS & JUMPERS

The various connectors are:

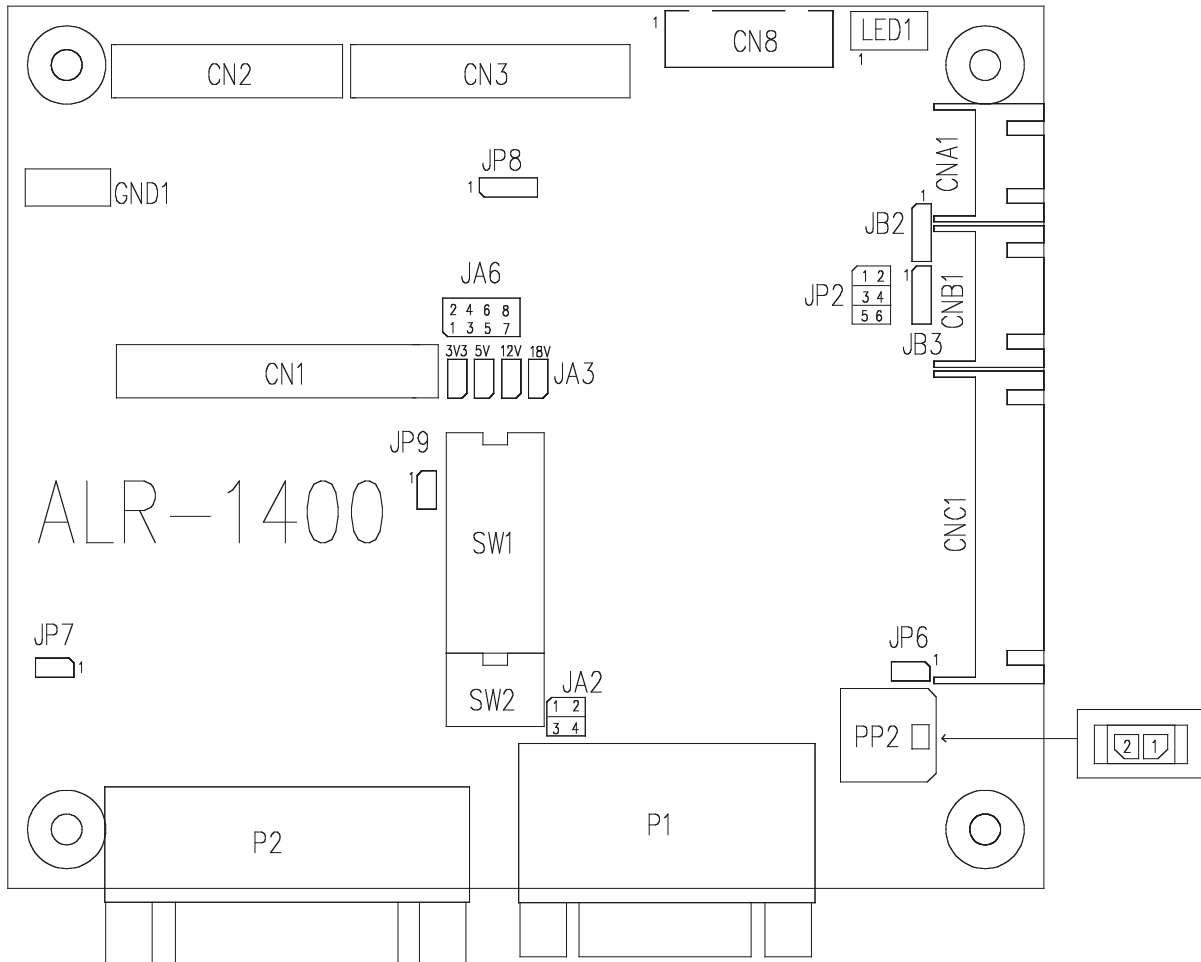

Summary: Connectors

Ref	Purpose	Description
CN1	LVDS panel signal	Hirose 40-pin, DF13-40DP-1.25DSA (Mating type : DF13-40DS-1.25C)
CN2	TTL panel signal	Hirose 40-pin, DF20G-40DP-1V (Mating type : DF20A-40DS-1C)
CN3	TTL Panel signal	Hirose 50-pin, DF20G-50DP-1V (Mating type : DF20A-50DS-1C)
CN8	Serial control (for firmware programming or RS-232 control use only)	JST 6-way, B6B-XH-A (Mating type : XHP-6)
CNA1	Auxiliary power output	JST 4-way, B4B-XH-A (Mating type : XHP-4)
CNB1	Backlight inverter	JST 5-way, B5B-XH-A (Mating type : XHP-5)
CNC1	Function controls	JST 12-way, B12B-XH-A (Mating type : XHP-12)
LED1	Dual color LED connector	Header pin 3x1
P1	ARGB signal input	DB-15 way high density 3 row
P2	DVI-D signal input	DVI-D connector
PP2	Power input	Molex 43650-0200 compatible (Mating type : Molex 43645-0200 compatible) (Matching power cable : P/N 426013800-3)

Summary: Jumpers setting

Ref	Purpose	Note
JA2	On board +5V power enable	1-2 & 3-4 closed, factory set, do not remove
JA3	Panel power voltage select	See panel voltage setting table 1 CAUTION: Incorrect setting will cause panel damage
JA6	Panel power voltage select	See panel voltage setting table 1 CAUTION: Incorrect setting will cause panel damage
JB2	Backlight inverter on/off control – signal level	1-2 = On/Off control signal 'High' = +12V / +24VDC 2-3 = On/Off control signal 'High' = +5V Open = On/Off control signal 'High' = Open collector CAUTION: Incorrect setting can damage inverter.
JB3	Backlight inverter on/off control – polarity	1-2 = control signal 'high' = CCFT ON 2-3 = control signal 'low' = CCFT ON
JP2	Backlight control type selection	1-2 = VR/Digital switch mount control 3-4 = Analog backlight brightness controlled by RS-232 – voltage range 0~5V 5-6 = Reserved
JP6	Input power control	Short = External switch control Open = Switch mount control
JP7	Reserved	Reserved for internal programming use (Always 1-2 closed)
JP8	Clock phase (Analog RGB)	1-2 = Normal 2-3 = Invert
JP9	Reserved	1-2 = Default
SW1	Panel selection	See table below
SW2	Panel selection	See table below

Table 1 : Panel voltage setting table :

Input voltage via PP2	Panel Voltage	JA3	JA6	Jumper on board
12VDC	3.3V	3V3 closed	1-3 & 2-4	
	5V	5V closed	1-3 & 2-4	
	12V	OPEN	5-7 & 6-8	

CAUTION: Incorrect setting can damage panel & controller

Input voltage via PP2	Panel Voltage	JA3	JA6	Jumper on board
24VDC**	3.3V	3V3 closed	1-3 & 2-4	
	5V	5V closed	1-3 & 2-4	
	12V	12V closed	3-5 & 4-6	
	18V	18V closed	3-5 & 4-6	

**** Please make sure the backlight inverter must support 24V supply. Because CNA1 pin 1 and CNB1 pin 2 will output 24VDC if input 24VDC via PP2.**

JA3 & JA6 location on board : (Please pay attention to the jumper settings on JA3 & JA6 which are red in color on board)

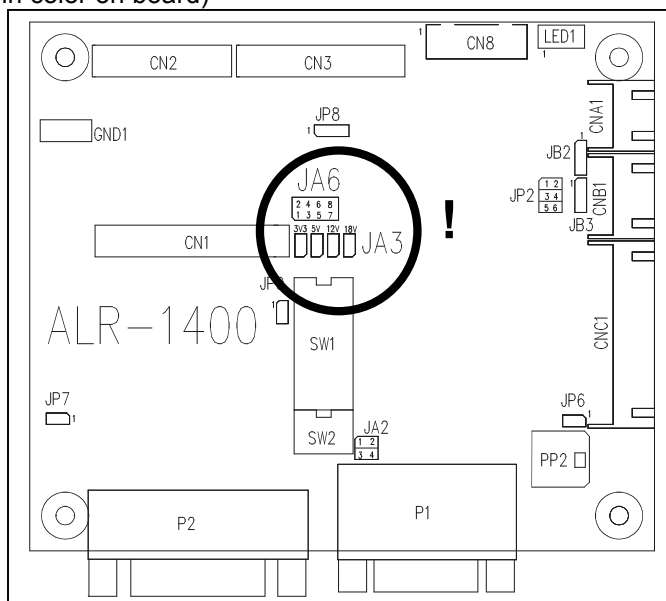

DIP Switch selection – SW1

Pos #1	Pos #2	Pos #3	Pos #4	Description	Panel resolution
For SXGA panel					
ON	ON	ON	OFF	Sharp LQ181E1LW31	1280x1024
				Fujitsu FLC48SXC8V	1280x1024
ON	OFF	OFF	ON	AU Optronics M190EG01 V0 ⁽²⁾	1280x1024
For WXGA panel					
ON	OFF	OFF	OFF	Samsung LTA260W2-L01 ⁽³⁾	1366x768
OFF	ON	OFF	OFF	NEC NL12876BC26-21	1280x768
OFF	ON	ON	OFF	Toshiba LTD089EXWS ⁽³⁾	1280x768
ON	ON	OFF	OFF	Samsung LTA460WS-L03 (Non-tested) ⁽¹⁾	1366x768
OFF	OFF	ON	OFF	Sharp LQ315T3LZ24 (Non-tested) ⁽¹⁾	1366x768
ON	OFF	ON	OFF	LG LC420W02-A4 (Non-tested) ⁽¹⁾	1366x768
For XGA panel					
OFF	ON	ON	OFF	LG LM151X2	1024x768
ON	ON	OFF	ON	Sharp LQ150X1LGB1	1024x768
				Sharp LQ150X1LGN2A	1024x768
				Fujitsu FLC38XGC6V-06	1024x768
ON	OFF	ON	ON	NEC NL10276BC12-02	1024x768
OFF	ON	ON	ON	NEC NL10276BC30-18C ⁽³⁾	1024x768
For SVGA panel					
OFF	OFF	ON	OFF	Sharp LQ121S1DG41	800x600
OFF	ON	ON	OFF	Sharp LQ084S3DG01 ⁽³⁾	800x600
ON	OFF	ON	OFF	Toshiba LTM12C289	800x600
ON	ON	ON	OFF	Toshiba LTM08C351 ⁽⁴⁾ (for 6 Bit panel)	800x600
OFF	OFF	OFF	ON	Sharp LQ104S1DG21 ⁽³⁾	800x600
For VGA / WVGA panel					
ON	OFF	OFF	OFF	Sharp LQ104V1DG21	640x480
				Sharp LQ10D368	640x480
				Sharp LQ104V1DG51	640x480
ON	ON	OFF	OFF	Sharp LQ64D343 ⁽²⁾	640x480
ON	OFF	ON	OFF	NEC NL6448AC33-29 ⁽³⁾	640x480
OFF	OFF	OFF	ON	PrimeView PD064VT5 ⁽³⁾	640x480
				NEC NL6448BC26-01 ⁽³⁾	640x480
ON	ON	OFF	ON	NEC NL6448BC33-50 ⁽⁴⁾	640x480
ON	OFF	ON	ON	NEC NL6448BC26-09 ^{(4)(c)}	640x480
OFF	OFF	ON	OFF	Toshiba LTA070A321F ⁽²⁾	800x480
ON	OFF	OFF	ON	Mitsubishi AA050MC01 ⁽³⁾	800x480
OFF	ON	OFF	ON	NEC NL8048BC19-02 ⁽⁴⁾	800x480
OFF	OFF	ON	ON	Sharp LQ070Y3LG4A ^{(4)(b)}	800x480
Others					
ON	OFF	OFF	OFF	Chunghwa CLAA070NA01CT ⁽³⁾	1024x600
OFF	ON	OFF	OFF	NEC NL12880BC20-02D ⁽³⁾	1280x800
ON	ON	OFF	OFF	NEC NL4823BC37-05 ^{(3)(a)}	480x234

For additional and recent added panels, see ALR-1400 panel support table at <http://www.digitalview.com/controllers/csg.php>

(1) Only effective on V1.31 or up version.

(2) Only effective on V1.61.00 or up version.

(3) Only effective on V1.76.00 or up version.

(4) Only effective on V1.80.00 or up version.

(a) Display at most output a 480x260 image when inputting 640x480 input resolution.

(b) Support 640x480 input resolution only come from ARGB & DVI. The vertical size will not fit for 800x600 resolution input.

(c) Flicker image is present when making image UP position adjustment in the OSD menu.

Pos #5	Pos #6	Pos #7	Description
OFF	OFF	OFF	Reserved
ON	OFF	OFF	Reserved
OFF	ON	OFF	SXGA
ON	ON	OFF	WXGA
OFF	OFF	ON	XGA
ON	OFF	ON	SVGA
OFF	ON	ON	VGA / WVGA
ON	ON	ON	Others

SW1 Pos 8 = Reserved.

DIP switch selection – SW2

Pos. #	Function	Description
1	Panel pixel format	OFF : Double Pixel ON : Single Pixel
2	LVDS data mapping select	ON : Mapping A (LVDS panel) OFF : Mapping B (LVDS panel) Please adjust to get the correct picture. See as Appendix II for details of mapping A and B. Set ON for TTL panels.

The most current list can be found the controller solution generator at <http://www.digitalview.com/controllers/csg.php>

CN1 – Panel connector: Hirose, DF13A-40DP-1.25DSA (Matching type : DF13-40DS-1.25C)

PIN	SYMBOL	DESCRIPTION
1	TXA0+	Positive differential LVDS data bit A0
2	TXA0-	Negative differential LVDS data bit A0
3	TXA1+	Positive differential LVDS data bit A1
4	TXA1-	Negative differential LVDS data bit A1
5	Reserved	-
6	Reserved	-
7	TXA2+	Positive differential LVDS data bit A2
8	TXA2-	Negative differential LVDS data bit A2
9	TXA3+	Positive differential LVDS data bit A3
10	TXA3-	Negative differential LVDS data bit A3
11	GND	Ground
12	GND	Ground
13	TXAC+	Positive LVDS clock for A channel
14	TXAC-	Negative LVDS clock for A channel
15	GND	Ground
16	GND	Ground
17	TXB0+	Positive differential LVDS data bit B0
18	TXB0-	Negative differential LVDS data bit B0
19	TXB1+	Positive differential LVDS data bit B1
20	TXB1-	Negative differential LVDS data bit B1
21	Reserved	-
22	Reserved	-
23	TXB2+	Positive differential LVDS data bit B2
24	TXB2-	Negative differential LVDS data bit B2
25	TXB3+	Positive differential LVDS data bit B3
26	TXB3-	Negative differential LVDS data bit B3
27	GND	Ground
28	GND	Ground
29	TXBC+	Positive LVDS clock for B channel
30	TXBC-	Negative LVDS clock for B channel
31	GND	Ground
32	GND	Ground
33	VDD (3,3V/5V)	Panel power supply (3,3V/5V) (selected by JA3 & JA6)
34	VDD (3,3V/5V)	Panel power supply (3,3V/5V) (selected by JA3 & JA6)
35	VDD (3,3V/5V)	Panel power supply (3,3V/5V) (selected by JA3 & JA6)
36	VDD (3,3V/5V)	Panel power supply (3,3V/5V) (selected by JA3 & JA6)
37	NC	No connection
38	VDD (+12V/18V)	Panel power supply (+12V / 18V) (selected by JA3 & JA6)
39	VDD (+12V/18V)	Panel power supply (+12V / 18V) (selected by JA3 & JA6)
40	VDD (+12V/18V)	Panel power supply (+12V / 18V) (selected by JA3 & JA6)

CN2 – Panel connector: HIROSE DG20G-40DP-1V (Matching type : DF20A-40DS-1C)

PIN	SYMBOL	DESCRIPTION
1	GND	Ground
2	GND	Ground
3	NC	No connection
4	NC	No connection
5	ER0	Even data bit R0
6	ER1	Even data bit R1
7	ER2	Even data bit R2
8	ER3	Even data bit R3
9	ER4	Even data bit R4
10	ER5	Even data bit R5
11	ER6	Even data bit R6
12	ER7	Even data bit R7
13	GND	Ground
14	GND	Ground
15	NC	No connection
16	NC	No connection
17	EG0	Even data bit G0
18	EG1	Even data bit G1
19	EG2	Even data bit G2
20	EG3	Even data bit G3
21	EG4	Even data bit G4
22	EG5	Even data bit G5
23	EG6	Even data bit G6
24	EG7	Even data bit G7
25	GND	Ground
26	GND	Ground
27	NC	No connection
28	NC	No connection

29	EB0	Even data bit B0
30	EB1	Even data bit B1
31	EB2	Even data bit B2
32	EB3	Even data bit B3
33	EB4	Even data bit B4
34	EB5	Even data bit B5
35	EB6	Even data bit B6
36	EB7	Even data bit B7
37	GND	Ground
38	GND	Ground
39	CLK	Dot clock
40	NC	No connection

CN3 – Panel connector: HIROSE DF20G-50DP-1V (Matching type : DF20A-50DS-1C)

PIN	SYMBOL	DESCRIPTION
1	GND	Ground
2	GND	Ground
3	NC	No connection
4	NC	No connection
5	OR0	Odd data bit R0
6	OR1	Odd data bit R1
7	OR2	Odd data bit R2
8	OR3	Odd data bit R3
9	OR4	Odd data bit R4
10	OR5	Odd data bit R5
11	OR6	Odd data bit R6
12	OR7	Odd data bit R7
13	GND	Ground
14	GND	Ground
15	NC	No connection
16	NC	No connection
17	OG0	Odd data bit G0
18	OG1	Odd data bit G1
19	OG2	Odd data bit G2
20	OG3	Odd data bit G3
21	OG4	Odd data bit G4
22	OG5	Odd data bit G5
23	OG6	Odd data bit G6
24	OG7	Odd data bit G7
25	GND	Ground
26	GND	Ground
27	NC	No connection
28	NC	No connection
29	OB0	Odd data bit B0
30	OB1	Odd data bit B1
31	OB2	Odd data bit B2
32	OB3	Odd data bit B3
33	OB4	Odd data bit B4
34	OB5	Odd data bit B5
35	OB6	Odd data bit B6
36	OB7	Odd data bit B7
37	GND	Ground
38	GND	Ground
39	VS	Vertical sync
40	CLK	Dot clock
41	HS	Horizontal sync
42	DE	Display enable
43	PWR	Power down control signal (5v TTL)
44	VLCD	Panel power supply (3,3V/5V) (selected by JA3 & JA6)
45	VLCD	Panel power supply (3,3V/5V) (selected by JA3 & JA6)
46	VLCD	Panel power supply (3,3V/5V) (selected by JA3 & JA6)
47	NC	No connection
48	VLCD12/18	+12V/18V panel supply (selected by JA3 & JA6)
49	VLCD12/18	+12V/18V panel supply (selected by JA3 & JA6)
50	VLCD12/18	+12V/18V panel supply (selected by JA3 & JA6)

CN8 – RS-232 serial control: JST B6B-XH-A (Matching type : XHP-6)

PIN	SYMBOL	DESCRIPTION
1	SDATA	Reserved
2	SCLK	Reserved
3	VCC	+5V
4	TXD	RS-232 Tx data
5	GND	Ground
6	RXD	RS-232 Rx data

CNA1 - Auxiliary power output: JST B4B-XH-A (Matching type : XHP-4)

PIN	SYMBOL	DESCRIPTION
1	AUX POWER	+12V DC, 500mA max / +24V DC, 3A max
2	GND	Ground
3	GND	Ground
4	AUX 5V	+5V DC, 500mA max

CNB1 – Backlight inverter connector: JST B5B-XH-A (Matching type : XHP-5)

PIN	SYMBOL	DESCRIPTION
1	GND	Ground
2	VBKL	Backlight power supply, +12VDC / +24V DC, 3A max
3	BLCTRL	Backlight On/Off control signal (refer to JB2 & JB3)
4	BVR_WIP	Backlight brightness VR pin WIP
5	BVR_A	Backlight brightness VR pin A

CNC1 – Control switch, JST B12B-XH-A

PIN	SYMBOL	DESCRIPTION
1	PSWIN	Power button A
2	SW_ON	Power button B
3	BVR_A	Backlight Brightness VR pin A
4	BVR_WIP	Backlight Brightness R pin WIP
5	BVR_B	Backlight Brightness VR pin B (470 ohm resistor to +5V Vcc)
6	GND	Ground
7	MENU	OSD menu
8	-/LEFT	OSD -/Left
9	+ /RIGHT	OSD +/Right
10	SEL_DN	OSD Select down
11	SEL_UP	OSD Select up
12	NC	No connection

LED1 – Status LED connector: 3-pin header

PIN	DESCRIPTION
1	Green LED pin (anode)
2	LED pin common (cathode)
3	Red LED pin (anode)

P1 - Analog VGA input – DB-15 way high density 3 row

PIN	SYMBOL	DESCRIPTION
1	PCR	Red, analog
2	PCG	Green, analog
3	PCB	Blue analog
4	ID2	Reserved for monitor ID bit 2 (grounded)
5	DGND	Digital ground
6	AGND	Analog ground red
7	AGND	Analog ground green
8	AGND	Analog ground blue
9	DDC_5V	+5V power supply for DDC (optional)
10	DGND	Digital ground
11	ID0	Reserved for monitor ID bit 0 (grounded)
12	DDC_SDA	DDC serial data
13	HS_IN	Horizontal sync or composite sync, input
14	VS_IN	Vertical sync, input
15	DDC_SCL	DDC serial clock

P2 – DVI-D input

PIN	SYMBOL	DESCRIPTION
1	/RX2	TMDS Data 2-
2	RX2	TMDS Data 2+
3	GND	Digital Ground
4	NC	No connection
5	NC	No connection
6	DVI_DDC_CLK	DDC Clock
7	DVI_DDC_DAT	DDC Data
8	DVI_VS_IN	Analog vertical Sync
9	/RX1	TMDS Data 1-
10	RX1	TMDS Data 1+
11	GND	Digital Ground
12	NC	No connection
13	NC	No connection
14	DVI_DDC_5V	+5V power supply for DDC (optional)
15	GND	Ground (+5, Analog H/V Sync)
16	NC	No connection
17	/RX0	TMDS Data 0-
18	RX0	TMDS Data 0+
19	GND	Digital Ground
20	NC	No connection
21	NC	No connection
22	GND	Digital Ground
23	RXC	TMDS Clock+
24	/RXC	TMDS Clock-
25	NC	No connection
26	NC	No connection

PP2 - Power supply

PIN	DESCRIPTION
1	+12VDC 5A max / +24VDC 5A max
2	Ground

CONTROLLER DIMENSIONS

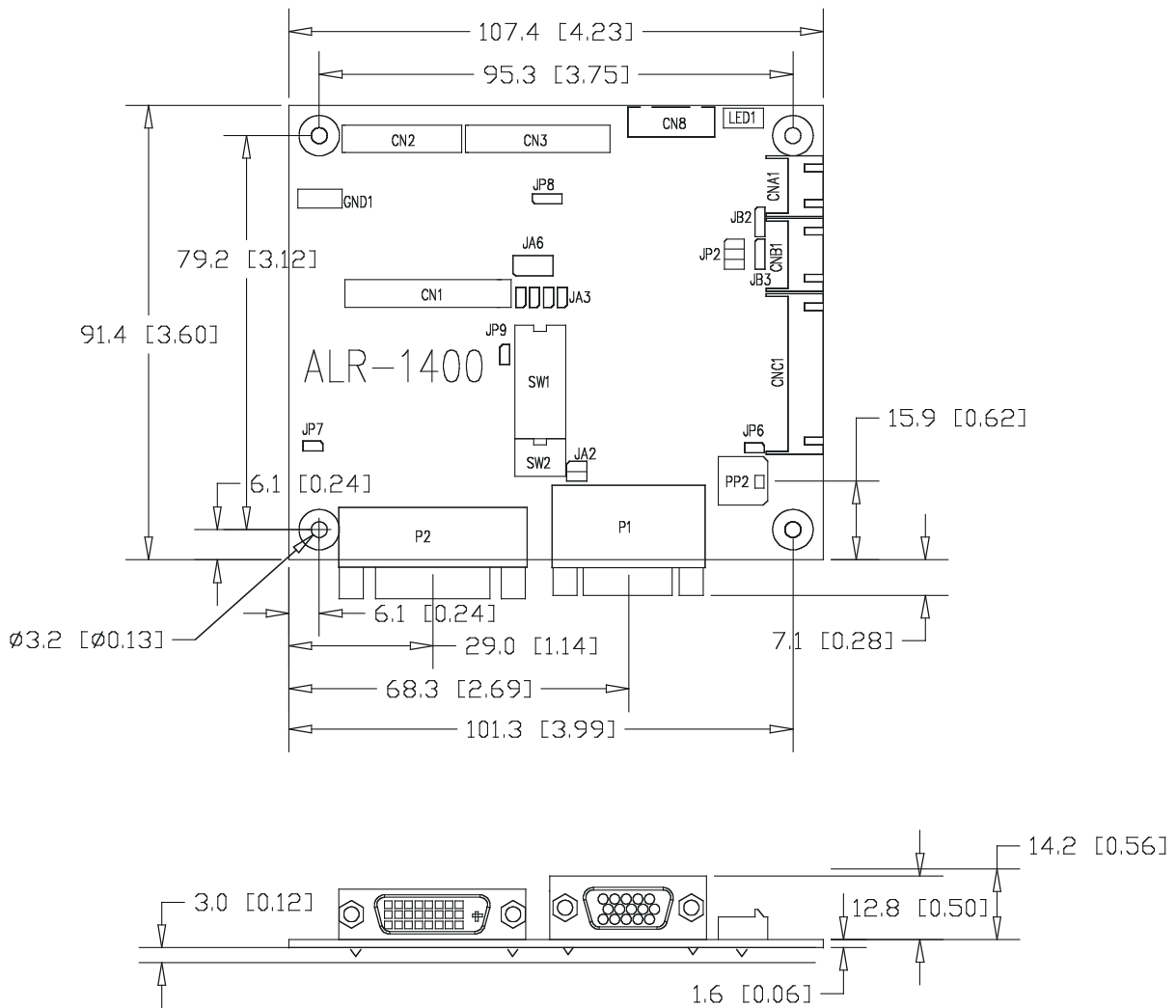

The maximum thickness of the controller is 15.8mm (measured from bottom of PCB to top of components, including any underside components & leads). We recommend clearances of:

- 5mm from bottom of PCB - if mounting on a metal plate we also recommend a layer of suitable insulation material is added to the mounting plate surface.
- 10mm above the components
- 3~5mm around the edges

Any of the holes shown above can be used for mounting the PCB, they are 3.2mm in diameter.

CAUTION: Ensure adequate insulation is provided for all areas of the PCB with special attention to high voltage parts such as the inverter.

APPLICATION NOTES

USING THE CONTROLLER WITHOUT BUTTONS ATTACHED

This is very straightforward by following the steps below :

- Firstly setup the controller/display system with the buttons. With controls attached and display system active make any settings for colour and image position as required then switch everything off.
- Use a jumper to close JP6 jumper, this will fix the board On.
- Refer to inverter specifications for details as to fixing brightness to a desired level, this may require a resistor, an open circuit or closed circuit depending on inverter.

INVERTER CONNECTION

There are potentially 3 issues to consider with inverter connection:

- Power
- Enable
- Brightness

Please read the following sections for a guide to these issues.

Inverter Power: As per the table for CNB1 pin 1 is ground and pin 2 provides DC12V/ 24V DC . This should be matched with the inverter specification: see table.

CNB1

PIN	DESCRIPTION
1	Ground
2	+12VDC / 24VDC

Remark: For higher power inverter, more current (for 12V / 24V) can be taken from CNA1 pin 1. Maximum current drawn on CNA1 pin 1 and CNB1 pin 2 is 3A (24V) / 3A(12V)

Enable: This is a pin provided on some inverters for On/Off function and is used by this panel controller for VESA DPMS compliance. If the inverter does not have an enable pin or the enable pin is not used then DPMS will not be operational. Pin 3 should be matched to the inverters specification for the 'enable' or 'disable' pin.

CNB1

PIN	DESCRIPTION
3	Enable

Further, jumpers JB2 & JB3 should be set to match the inverters specification for the enable pin power and High or Low setting: see table.

Ref	Purpose	Note
JB2	Inverter enable voltage	1-2 H = 12V/24V, 2-3 H = 5V (Vcc), OPEN H = open collector
JB3	Inverter control	1-2 H = On, 2-3 L = On

Brightness: There are various methods for brightness control and it is important to consider the specifications for the inverter to be used. Generally the situation is:

- Brightness can controlled by using a resistor or VR (Variable Resistor).
- Brightness controlled by adding a circuit such as PWM (Pulse Width Modulation).
- No adjustment of brightness is possible.

CNB1 pins 4 & 5 are available for connecting to an inverter or circuit where VR control is supported.

CNB1

PIN	DESCRIPTION
4	VR WIP
5	VR A

This can then be matched with function controls (OSD switch mount) pins 3 & 4: see cable design below .

Design Guideline for making VR circuitry :

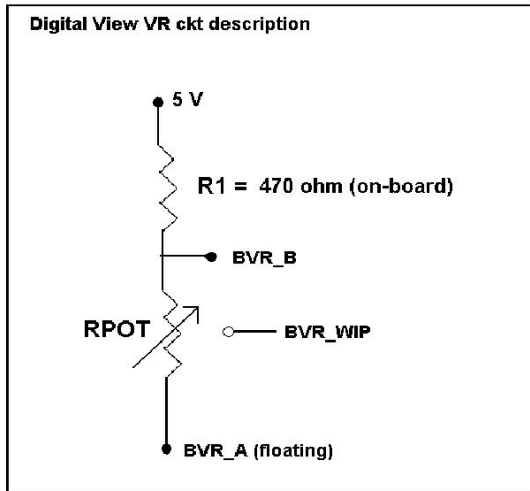

Signal description / Notes :

- 1) R1 : 470ohm on board
- 2) RPOT is an external potentiometer (in-line dip style) that can be plugged directly into CNC1 pins 3,4,5. RPOT must be supplied / installed by user.
- 3) BVR_B : Voltage tapped from “top” of potentiometer, the node of R1 and RPOT.
- 4) BVR_WIP : Voltage tapped from wiper arm of RPOT.
- 5) BVR_A : Voltage tapped from “bottom” of RPOT.

Note : BVR_A voltage is left floating on the controller board. To use this circuit, you need to tie this point to a potential (usually GND, available at CNC1 pin 6).

CNB1 – Backlight inverter connector: JST B5B-XH-A (Matching type : XHP-5)

PIN	SYMBOL	DESCRIPTION
1	GND	Ground
2	VBKL	+12VDC / 24VDC, backlight power supply (selected by JA3 & JA6)
3	BLCTRL	On/Off control (enable) – see JB2 & JB3
4	BVR_WIP	Brightness VR - WIP
5	BVR_A	Brightness VR A

CNC1 – Control switch, JST B12B-XH-A (Matching type : XHP-12)

PIN	SYMBOL	DESCRIPTION
1	PSWIN	Power button A
2	SW_ON	Power button B
3	BVR_A	Backlight Brightness VR pin A
4	BVR_WIP	Backlight Brightness R pin WIP
5	BVR_B	Backlight Brightness VR pin B (470 ohm resistor to +5V Vcc)
6	GND	Ground
7	MENU	OSD menu
8	-/LEFT	OSD -/Left
9	+ /RIGHT	OSD +/Right
10	SEL_DN	OSD Select down
11	SEL_UP	OSD Select up
12	NC	No connection

The VR for brightness depends on the inverter. The main power load for On/Off is handled by a relay on the controller.

Example for circuit design :

- 1.) Choose RPOT = 10K
- 2.) Tie BVR_A to GND
- 3.) Circuit analysis gives BVR_WIP as the following (see Figure 1)

$$BVR_WIP = 5 \times (Rbc/10.47)$$

where BVR_WIP is in Volts.
And Rbc is the resistance from the wiper arm to bottom of pot in Kohms.

To evaluate, plug in different values of Rbc :

Rbc	BVR_WIP
0	0 V
2.5 K	1.2 V
5 K	2.4 V
7.5 K	3.6 V
10 K	4.8 V

So this circuit could provide Brightness adjust voltage ranging from 0V to 5V.

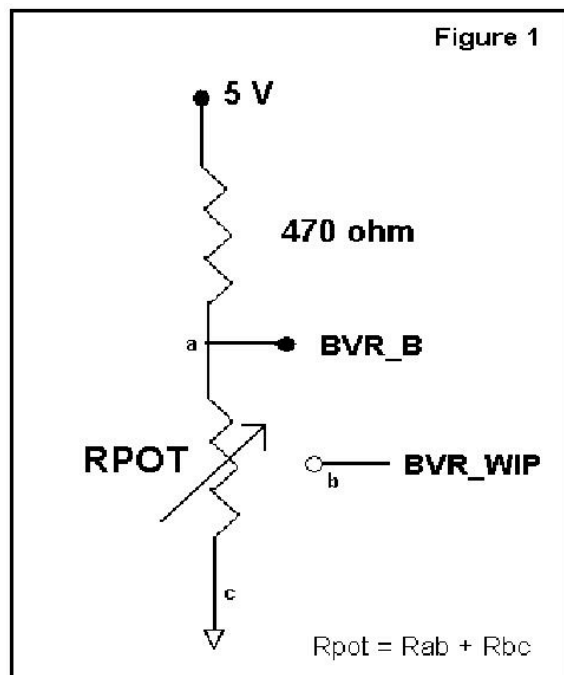

TROUBLESHOOTING

General

A general guide to troubleshooting a flat panel display system it is worth considering the system as separate elements, such as:

- Controller (jumpers, PC settings)
- Panel (controller, cabling, connection, panel, PC settings)
- Backlight (inverter, cabling, backlight tubes)
- Cabling
- Computer system (display settings, operating system)

Through step by step cross checking with instruction manuals and a process of elimination to isolate the problem it is usually possible to clearly identify the problem area.

No image:

- If the panel backlight is not working it may still be possible to just see some image on the display.
- A lack of image is most likely to be caused by incorrect connection, lack of power, failure to provide a signal or incorrect graphic card settings.

Image position:

If it is impossible to position the image correctly, ie the image adjustment controls will not move the image far enough, then test using another graphics card. This situation can occur with a custom graphics card that is not close to standard timings or if something is in the graphics line that may be affecting the signal such as a signal splitter (please note that normally a signal splitter will not have any adverse effect).

Image appearance:

- A faulty panel can have blank lines, failed sections, flickering or flashing display
- Incorrect graphics card refresh rate, resolution or interlaced mode will probably cause the image to be the wrong size, to scroll, flicker badly or possibly even no image.
- Incorrect jumper settings on the controller may cause everything from total failure to incorrect image. CAUTION: Do not set the panel power input incorrectly.
- Sparkling on the display: faulty panel signal cable.

Backlight:

Items to check include: Power input, Controls, Inverter and Tubes generally in this order.

If half the screen is dimmer than the other half:

- Check cabling for the inverter.
- For a specific backlight tube check the AC pins orientation (CAUTION: Never reverse any DC power pins).

Also:

- If adjusting brightness control has no effect the chances are that the VR rating or method of adjusting brightness is not compatible or correctly connected to the inverter.
- If system does not power down when there is a loss of signal

Continued failure:

If unit after unit keeps failing consider and investigate whether you are short circuiting the equipment or doing something else seriously wrong.

Generally after common sense issues have been resolved we recommend step by step substitution of known working parts to isolate the problem.

SPECIFICATIONS

Panel compatibility	1366x768, 1280x1024, 1280x800, 1280x768, 1024 x 768, 1024x600, 800x600, 800x480, 640x480 or 480x234 resolution TFT LVDS or TTL LCD's support.
No. of colours	Up to 3 x 8 bit providing 16.7 million colours.
Vertical refresh rate	SXGA, XGA, SVGA, VGA resolution up to 60Hz.
Dot clock (pixel clock) maximum	135 MHz
Graphics formats	Standard SXGA, XGA, SVGA, VGA
Standard input at source	- VGA analog (15-pin) standard with automatic detection of : Digital Separate Sync Sync-On-Green Composite Sync - DVI-D
Controls available	- On/Off - Brightness (inverter) - OSD menu - OSD select - OSD setting + - OSD setting -
Control interface	- Buttons
Settings memory	Settings are stored in non volatile memory
Language OSD support	Graphics OSD icons
VESA DPMS implementation	Yes
Plug & Play	VESA DDC 1, 2/b compatible
Voltage output for LCD	+3.3V , +5V, +12V, +18V The current drawn for 18V panel from 24VDC power input is limited to 2A. The current drawn for 3.3V, 5V or 12V panel from 12V/24VDC power input is limited to 3A.
Input voltage	12VDC , 5A max / 24VDC 5A max +/- 5%
Controller power consumption	Approx 4W (controller logic only, no panel and inverter are involved)
Controller dimensions	107mm x 92mm x 21mm
Storage temperature limits	-40°C to +70°C
Operating temperature limits	0°C to +60°C

NOTES

Please note the following:

- For specific panel setup a sample of an LCD may be required (this will be returned) and a copy of the full technical specifications for the panel from the manufacturer.
- Relay and custom development services are available.

Appendix I – Graphic Mode Support Table

Mode	Resolution	Clk [MHz]	Horizontal freq [KHz]	Vertical freq [Hz]	Sync Mode
E1_70	640x350 70Hz	25.175	31.469	70.087	Digital Separate Sync
E2_70	640x400 70Hz	25.175	31.469	70.087	Digital Separate Sync
V_60	640x480 60Hz	25.175	31.469	59.940	Digital Separate Sync
V_60	640x480 60Hz	25.175	31.469	59.940	Sync On Green
V_60	640x480 60Hz	25.175	31.469	59.940	Composite Sync
SV_56	800x600 56Hz	36.000	35.156	56.250	Digital Separate Sync
SV_56	800x600 56Hz	36.000	35.156	56.250	Sync On Green
SV_56	800x600 56Hz	36.000	35.156	56.250	Composite Sync
SV_60	800x600 60Hz	40.000	37.879	60.317	Digital Separate Sync
SV_60	800x600 60Hz	40.000	37.879	60.317	Sync On Green
SV_60	800x600 60Hz	40.000	37.879	60.317	Composite Sync
X_60	1024x768 60Hz	65.000	48.363	60.004	Digital Separate Sync
X_60	1024x768 60Hz	65.000	48.363	60.004	Sync On Green
X_60	1024x768 60Hz	65.000	48.363	60.004	Composite Sync
SX_60	1280x1024 60Hz	108	63.81	60.020	Digital Separate Sync
SX_60	1280x1024 60Hz	108	63.81	60.020	Sync On Green
SX_60	1280x1024 60Hz	108	63.81	60.020	Composite Sync

Remark :

The controller has been designed to take a very wide range of input signals however to optimize the PC's graphics performance we recommend choosing 60Hz vertical refresh rate. To support on higher refresh rate over 60Hz, the LCD panel may not support.

Appendix II – RS-232 control protocols

RS-232 Serial control (Baud rate 2400, 8 bits, 1 stop bit and no parity)

Physical connection :

Controller side
Connector interface : CN8
Mating connector : JST XHP-6

Computer side
Connector interface : Serial port
Mating connector : DB9 Female



Mating face of CN8



Mating face of RS-232 DB9 Male

PIN#	Description
4	RS-232 Tx Data
5	Ground
6	RS-232 Rx Data

PIN#	Description
2	RS-232 Rx Data
3	RS-232 Tx Data
5	Ground

Remark :

(1) : RS-232 connection cable, 600mm P/N 4260902-00 can be ordered separately for connection.

Software connection :

The OSD function can be controlled through sending the RS-232 protocol.

The RS-232 program can be custom-made to fit for application or it can be used the program provided by Digitalview on request. Please contact your local sales for informations.

1. Commands to implement switch mount control buttons

Function	Command	Description	Acknowledge (if enabled)
OSD Menu Lock	0xf6	OSD menu Lock Off / OSD menu Lock On	Button equivalent
Menu	0xf7	Menu button pressed	Button equivalent
Select-down button	0xfa	Select down button pressed	Button equivalent
Select-up button	0xfb	Select up button pressed	Button equivalent
Right/+ button	0xfc	Right/+button pressed	Button equivalent
Left/- button	0xfd	Left/- button pressed	Button equivalent

2. Parameter setting - immediate, relative, reset and query

Function	Command	Description	Acknowledge (if enabled)
Brightness control	0x81, nn "+" "-" "r" "R" "?"	Set brightness = value/increment/decrement Reset Query	Brightness. Range: "0"0-"F"0 Default: "8"0
Contrast control	0x82, "a" "A", nn "+" "-" "r" "R" "?"	Set all contrast = value/increment/decrement Reset Query	Contrast. Range: "4"0-"F"0 Default: "8"0
Phase #	0x85, nn "+" "-" "?"	Set dot clock phase = value/increment/decrement Query	Dot clock phase. (In ARGB mode only)
Image H position #	0x86, nnnn "+" "-" "?"	Set img_hpos = value/increment/decrement Query	Image horizontal position. (In ARGB mode only)
Image V position #	0x87, nnnn "+" "-" "?"	Set img_vpos = value/increment/decrement Query	Image vertical position. (In ARGB mode only)
Frequency #	0x8b, nnnn "+" "-"	Set H active size = value/increment/decrement	Frequency adjustment (In ARGB mode only)

	"?"	Query	
Input main select * Function in valid mode only	0x98, nn "+" "-" "r" "R" "?"	Select input main = PC or video or next available Reset Query	Main selected. "0x41,0x31" ARGB (Default) "0x46,0x31" DVI
Colour temperature select	0xb3, n "r" "R" "?"	Select colour temperature = value Reset Query	Main selected. "0" – user defined RGB values. "1" – 4200K. "2" – 5000K. "3" – 6500K. "4" – 7500K. (Default) "5" – 9300K.
Red level for selected colour temperature	0xb4, nn "+" "-" "r" "R" "?"	Set the level of the red channel for the selected colour temp. = value/increment/decrement Reset Query	Red level for selected colour temperature. Range: "8"0"-F"F" Default: "F"F"
Green level for selected colour temperature	0xb5, nn "+" "-" "r" "R" "?"	Set the level of the green channel for the selected colour temp. = value/increment/decrement Reset Query	Green level for selected colour temperature. Range: "8"0"-F"F" Default: "F"F"
Blue level for selected colour temperature	0xb6, nn "+" "-" "r" "R" "?"	Set the level of the blue channel for the selected colour temp. = value/increment/decrement Reset Query	Blue level for selected colour temperature. Range: "8"0"-F"F" Default: "F"F"
OSD turn off	0xbd	Turn off the OSD	"1" - successful
Backlight brightness control	0xe0, nn "+" "-" "r" "R" "?"	Set backlight brightness = value/increment/decrement Reset Query	Backlight brightness. Range: "0"0"-F"F" Default: "F"F" e.g "1"0" → 0xe0 0x31 0x30 * This control can only function when JP2 sets 3-4 closed * Apply for inverter control voltage in range of 0~5V. Each step interval is in 1
Backlight on/off control	0xe1, "0" "1" "r" "R" "?"	Set backlight brightness = Disable backlight Enable backlight Reset Query Backlight working status	Backlight on/off. "1" = normal (Default)
OSD menu Lock (Function available in V1.80.00 or later revision)	0xf6, n "0" "1" "r" "R" "?"	OSD menu Lock Off/ On Reset Query	"0" – OSD Lock Off "1" – OSD Lock On

- Function in ARGB mode only

3. Other control

Function	Command	Description	Acknowledge (if enabled)
Select RS-232 acknowledge	0xc1, "0" "1"	Disable/enable command acknowledge.	"0" – acknowledge disabled. "1" – acknowledge enabled.
Auto-setup [#]	0xc3	Start auto-setup of current mode.	"0" – fail. "1" – successful.
Command availability	0xc4, n	Check whether a command is available.	"0" – not available. "1" – available.
Auto-calibration [#]	0xc5	Start auto-calibration of gain of the RGB amplifier.	"0" – fail. "1" – successful.
Query BIOS version	0xcb, "0"	Read BIOS version	"nnnn" = BIOS ver. "nn.nn"
Query PCBA number	0xcb, "1"	Read PCBA number	"nnnn" = PCBA number ALR-1400="41710"
Load factory defaults	0xce	Reset all parameters to factory default value	"1" – successful.

- Function in ARGB mode only

Hex to ASCII conversion table

Hex	ASCII	Hex	ASCII	Hex	ASCII	Hex	ASCII
0x30	0	0x41	A	0x61	a	0x2B	+
0x31	1	0x42	B	0x62	b	0x2D	-
0x32	2	0x43	C	0x63	c	0x3F	?
0x33	3	0x44	D	0x64	d		
0x34	4	0x45	E	0x65	e		
0x35	5	0x46	F	0x66	f		
0x36	6	0x47	G	0x67	g		
0x37	7	0x48	H	0x68	h		
0x38	8	0x49	I	0x69	i		
0x39	9	0x4A	J	0x6A	j		
		0x4B	K	0x6B	k		
		0x4C	L	0x6C	l		
		0x4D	M	0x6D	m		
		0x4E	N	0x6E	n		
		0x4F	O	0x6F	o		
		0x50	P	0x70	p		
		0x51	Q	0x71	q		
		0x52	R	0x72	r		
		0x53	S	0x73	s		
		0x54	T	0x74	t		
		0x55	U	0x75	u		
		0x56	V	0x76	v		
		0x57	W	0x77	w		
		0x58	X	0x78	x		
		0x59	Y	0x79	y		
		0x5A	Z	0x7A	z		

Appendix III – Mapping definition

- Definition of Mapping A :

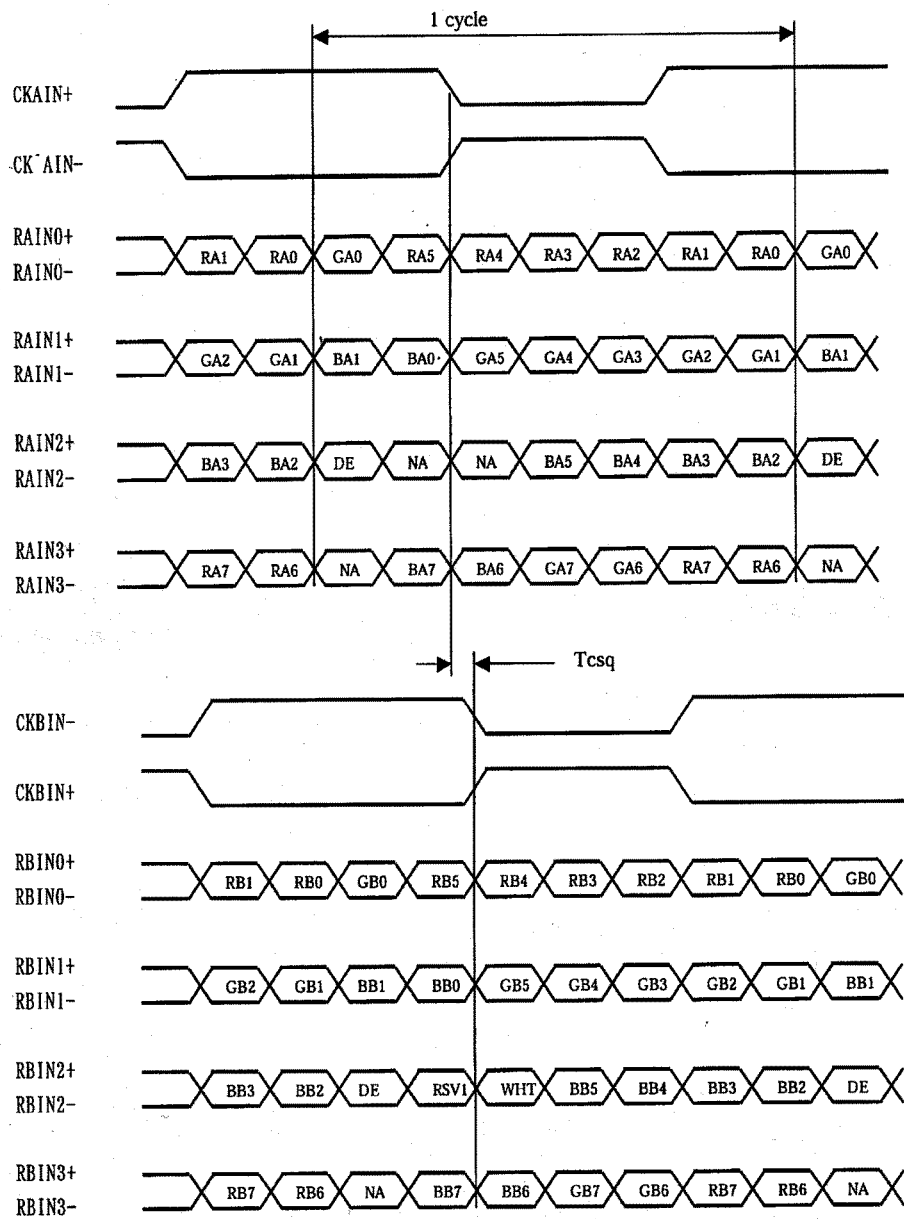

- Definition of Mapping B :

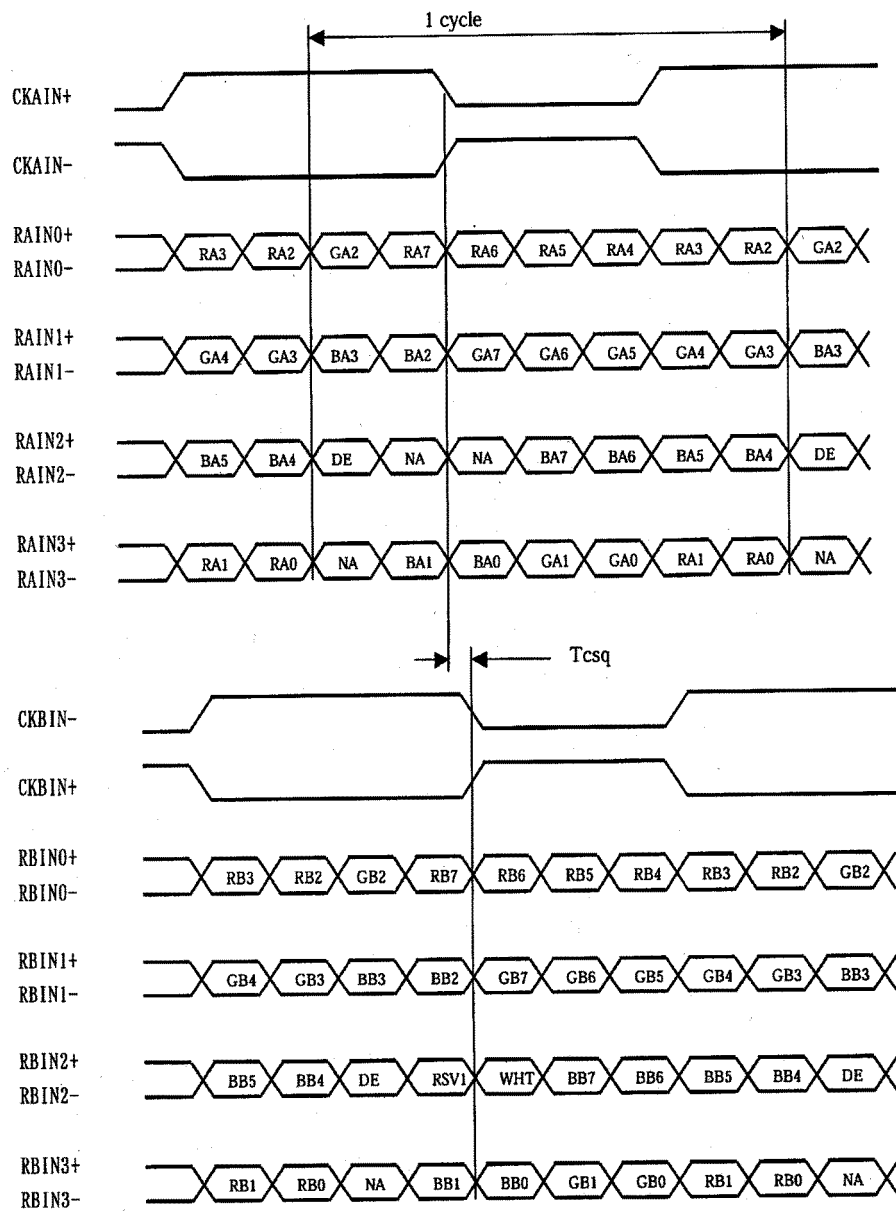

Appendix IV – Auto Color Gain

The Auto Color Gain function is supported in the ARGB mode only and is designed to calibrate the controller to the incoming video signal. In order to calibrate correctly, the display must be displaying an image containing both black and white data (see illustration below) when the function is used. The internal processor of the video controller chip will then execute a process to adjust the relative values of the RGB signals to achieve the best performance. The parameters of the corrected RGB values are then stored in the controller and are unaffected by the Reset Factory Defaults function.

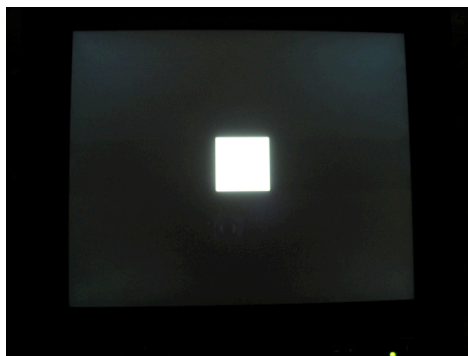

Warning - If the Auto Color Gain is executed without an appropriate image being displayed, then the process will set incorrect values and the display colors will be distorted. If this occurs, then it can either be corrected by performing the process correctly or if this is not possible then the Reset Color Gain function can be used. This function will reset the stored RGB values to a set of approximate values.

WARRANTY

The products are warranted against defects in workmanship and material for a period of three (3) year from the date of purchase provided no modifications are made to it and it is operated under normal conditions and in compliance with the instruction manual.

The warranty does not apply to:

- Product that has been installed incorrectly, this specifically includes but is not limited to cases where electrical short circuit is caused.
- Product that has been altered or repaired except by the manufacturer (or with the manufacturer's consent).
- Product that has subjected to misuse, accidents, abuse, negligence or unusual stress whether physical or electrical.
- Ordinary wear and tear.

Except for the above express warranties, the manufacturer disclaims all warranties on products furnished hereunder, including all implied warranties of merchantability and fitness for a particular application or purpose. The stated express warranties are in lieu of all obligations or liabilities on the part of the manufacturer for damages, including but not limited to special, indirect consequential damages arising out of or in connection with the use of or performance of the products.

CAUTION

Whilst care has been taken to provide as much detail as possible for use of this product it cannot be relied upon as an exhaustive source of information. This product is for use by suitably qualified persons who understand the nature of the work they are doing and are able to take suitable precautions and design and produce a product that is safe and meets regulatory requirements.

LIMITATION OF LIABILITY

The manufacturer's liability for damages to customer or others resulting from the use of any product supplied hereunder shall in no event exceed the purchase price of said product.

TRADEMARKS

The following are trademarks of Digital View Ltd:

- Digital View
- ALR-1400

CONTACT DETAILS

Digital View has offices in Asia, Europe and USA also an internet site:

ASIA

Digital View Ltd
16th Floor Millennium City 3
370 Kwun Tong Road
Kwun Tong
Hong Kong

Tel: (852) 2861 3615

Fax: (852) 2520 2987

Sales: hksales@digitalview.com

EUROPE

Digital View Ltd.
6 Marylebone Passage,
London, W1W 8EX
UK

Tel: +44-(0)20-7631-2150

Fax: +44-(0)20-7631-2156

Sales: uksales@digitalview.com

USA

Digital View Inc.
18440 Technology Drive
Building 130
Morgan Hill,
California, 95037
USA

Tel: (1) 408-782 7773

Fax: (1) 408-782 7883

Sales: ussales@digitalview.com

WEBSITE

www.digitalview.com

Specifications subject to change without notice
9th issue: 24 Nov, 2010 (ALR-1400.doc)

© Digital View Ltd 2006-2010

X-ON Electronics

Largest Supplier of Electrical and Electronic Components

Click to view similar products for [Display Modules](#) category:

Click to view products by [Digital View](#) manufacturer:

Other Similar products are found below :

[P6153-PR](#) [TDP0700T800480PCAP](#) [P6171DPR-DC-RS](#) [P6171DPR-DC-U](#) [TN0216ANVNANN-GN00](#) [TN0104ANVAANN-GN00](#)
[TN0181ANVNANN-GN00](#) [RVT43ULFNWC03 V4](#) [SM-RVT101HVBNWCA0](#) [SM-RVT35HHBFWCA0](#) [SM-RVT35HHBNWCA0](#) [SM-](#)
[RVT43HLBFWCA0](#) [SM-RVT43HLBNWCA0](#) [SM-RVT50HQBFWCA0](#) [SM-RVT50HQBNWCA0](#) [SM-RVT70HSBFWCA0](#) [SM-](#)
[RVT70HSBNWCA0](#) [LCM1602K-FL-YBW](#) [11769](#) [RVT28UEFNWC03](#) [RVT28UEFNWC05](#) [RVT50UQTNWC05](#) [RVT70AQFNWC00](#) [PIS-](#)
[0260](#) [ULCD-24PTU-AR](#) [2402980](#) [MIKROE-3158](#) [MIKROE-3159](#) [10563](#) [10737](#) [10829](#) [11870](#) [12030](#) [12219](#) [12287](#) [12824](#) [9201](#) [9904](#) [17-](#)
[8051-205](#) [98-0003-2525-2](#) [98-0003-2599-7](#) [98-0003-2664-9](#) [98-0003-3071-6](#) [MIKROE-3507](#) [MIKROE-3508](#) [MIKROE-3509](#) [MIKROE-](#)
[3510](#) [PH128800T004-ZFC](#) [EA SER164-NLW](#) [EA SER202-NLW](#)