

SINGLE PHASE HALL EFFECT LATCH FAN MOTOR DRIVER

Description

The AH5795 is a single chip solution for driving single-coil brushless direct current (BLDC) fans and motors. The integrated full-bridge driver output stage uses soft switching to minimize audible switching noise and electromagnetic interference (EMI) providing a low noise solution.

Motor speed can be controlled by either changing the duty ratio of the PWM signal at the PWM pin or by varying the supply voltage at Vdd pin.

To help protect the motor coil, the AH5795 provides Rotor Lock Protection which shuts down the output drive if rotor lock is detected. The device automatically re-starts when the rotor lock is removed. Over temperature shutdown provides thermal protection for the device.

A Tachometer output is provided by open-drain Frequency Generator (FG) Pin which allows external interface to monitor motor rotation or speed. The FG output is the magnetic change frequency.

The AH5795 is available in space saving and low profile TSOT23-6 and DFN2020C-6 packages.

Features

- Supports single-coil full-wave BLDC fan drivers
- Built-in Hall sensor and input amplifier
- Operating voltage: 1.8V to 6V
- Speed control methods
 - Vdd voltage speed control (PWM pin tied to Vdd)
 - PWM signal speed control via PWM pin
- Soft switching for low noise DC fan motor applications
- Rotor Lock Protection (Lock detection, output shutdown and automatic re-start)
- Toff clear when PWM is low for greater than 65ms
- Thermal protection
- Tachometer (FG) output
- No external timing capacitor - Reduces the numbers of external components required
- Low profile package: TSOT23-6 and DFN2020C-6
- “Green” Molding Compound (No Br, Sb) (Note 1)

Notes: 1. EU Directive 2002/95/EC (RoHS). All applicable RoHS exemptions applied. Please visit our website at http://www.diodes.com/products/lead_free.html.

Pin Assignments

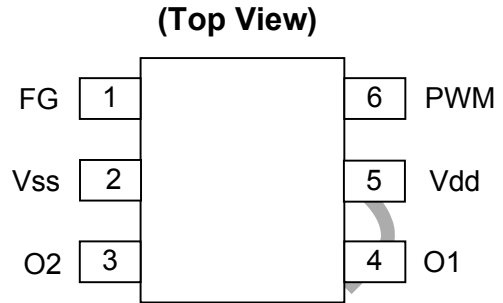

TSOT23-6

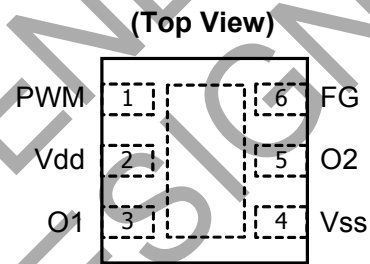

DFN2020C-6

Applications

- 3.3V / 5V BLDC Cooling Fans
- Netbook/ Notebook BLDC fans
- Instruments cooling fans
- Low Voltage/ Low Power BLDC Motors

Typical Application Circuit

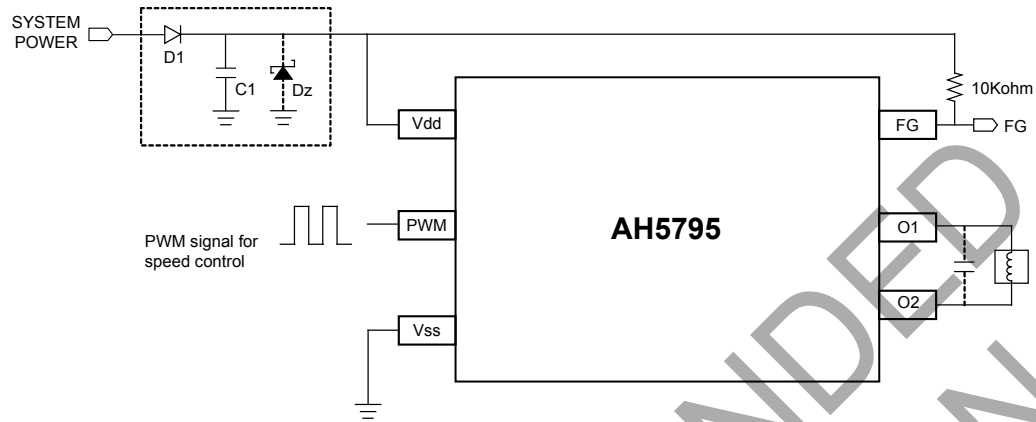

Pin Descriptions

Pin Name	Description
V _{DD}	Power supply pin
V _{SS}	Ground pin
O1	Output driving & sinking pin
O2	Output driving & sinking pin
PWM	PWM signal input pin for speed control
FG	Frequency Generator (Note 2)

Notes: 2. The FG output is the same as the magnetic change frequency.

NOT RECOMMENDED FOR NEW DESIGN

Functional Block Diagram (Note 3)

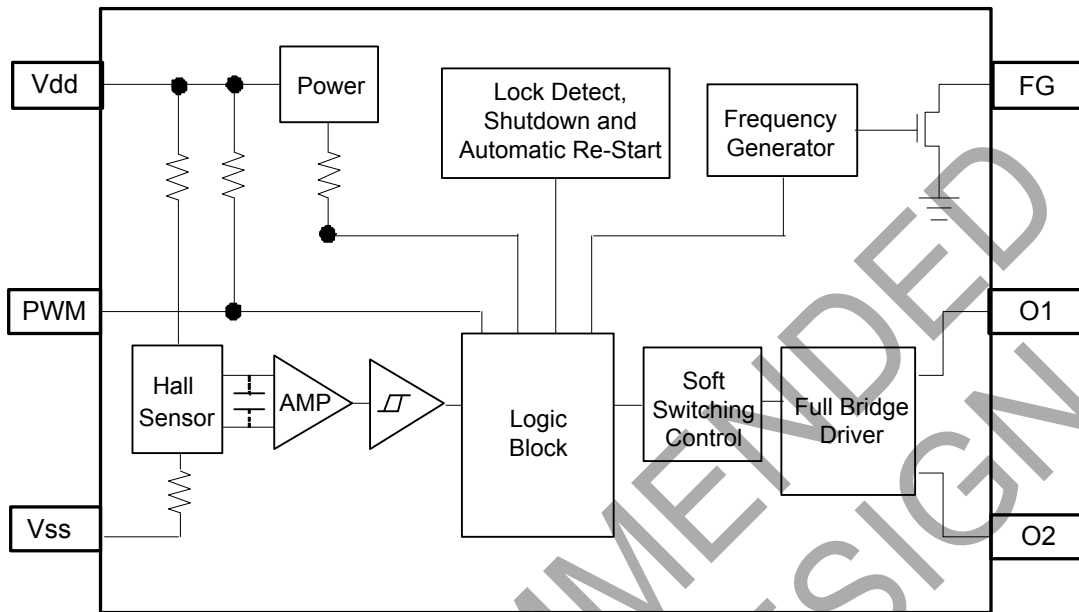

Notes: 3. The AH5795 has an open-drain tachometer FG output that follows the magnetic change frequency. Typically a pull-up resistor of 10KΩ is recommended from FG pin to the supply voltage.

NOT RECOMMENDED FOR NEW DESIGN

SINGLE PHASE HALL EFFECT LATCH FAN MOTOR DRIVER
Absolute Maximum Ratings (T_A = 25°C, unless otherwise noted, Note 4)

Symbol	Characteristics	Values	Unit
V _{DD}	Supply voltage	7	V
I _{O(PEAK)}	Maximum Output Current (Peak)	1000mA	mA
P _D	Power Dissipation	TSOT23-6	650
		DFN2020C-6	780 (Note 5)
T _{ST}	Storage Temperature Range	-65 ~ 150	°C
ESD HBM	Human Body Model (HBM) ESD Protection	4	kV

- Notes:
- Stresses greater than the 'Absolute Maximum Ratings' specified above, may cause permanent damage to the device. These are stress ratings only; functional operation of the device at these or any other conditions exceeding those indicated in this specification is not implied. Device reliability may be affected by exposure to absolute maximum rating conditions for extended periods of time
 - DFN2020C-6 exposed pad soldered to minimum recommended landing pads (see Package Outline Dimension section) on a two-layer 2oz. copper FR4 PCB (1.6mm thickness) with no thermal vias in exposed PADs or any copper flood connecting to the landing pattern of the exposed pad.

Recommended Operating Conditions (T_A = 25°C)

Symbol	Parameter	Conditions	Min	Max	Unit
V _{DD}	Supply Voltage	Operating	1.8	6.0	V
T _A	Operating Ambient Temperature Range	Operating	-40	105	°C

Electrical Characteristics (T_A = 25°C, V_{DD} = 5V)

Symbol	Characteristics	Conditions	Min	Typ.	Max	Unit
I _{DD}	Supply Current	No Load	-	2.2	-	mA
V _{OH}	Output Voltage High	I _{OUT} = 300mA	4.70	4.88	-	V
		I _{OUT} = 500mA	4.5	4.8	-	V
V _{OL}	Output Voltage Low	I _{OUT} = 300mA	-	0.12	0.3	V
		I _{OUT} = 500mA	-	0.2	0.5	V
V _{OH} +V _{OL}	Output voltage of N- and PMOS combined	I _{OUT} = 300mA	-	0.3	0.6	V
		I _{OUT} = 500mA	-	0.5	-	V
T _{SW}	Output Switching Slope Duration	17Ω load on out1/out2	-	200	-	μs
I _{LEAK}	FG Output Leakage Current		-	-	5	μA
V _{FGOL}	FG Output Voltage Low	I _{FG} = 5mA	-	-	0.4	V
T _{ON}	On Time		350	500	650	ms
R _{DR}	Duty Ratio	T _{OFF} / T _{ON}	-	10	-	
V _{PWMH}	PWM Input H Level		0.5 V _{DD}	-	V _{DD}	V
V _{PWML}	PWM Input L Level		0	-	0.14 V _{DD}	V
I _{PWMH}	PWM Input current H Level	PWM=V _{DD}		0		μA
I _{PWML}	PWM Input current L Level	PWM=GND		-10		μA
F _{PWM}	PWM Input Frequency		0.02	-	50	KHz
D _{PWM MIN}	Output minimum duty ratio	Motor rotating;	10%		100	%
T _{J_SDN_TH}	IC junction temperature thermal shutdown threshold			175		°C
T _{J_SDN_HYST}	IC junction temperature thermal shutdown hysteresis			25		°C

SINGLE PHASE HALL EFFECT LATCH FAN MOTOR DRIVER

Magnetic Characteristics ($T_A = 25^\circ\text{C}$, $V_{DD} = 1.8\text{V}\sim 6\text{V}$, Note 6)

(1mT = 10 G)

Symbol	Parameter	Min	Typ.	Max	Unit
B_{op}	Operate Point	10	25	50	Gauss
B_{rp}	Release Point	-50	-25	-10	
B_{hy}	Hysteresis	-	50	-	

Notes: 6. Magnetic characteristics may vary with supply voltage, operating temperature and after soldering.

Operating Characteristics

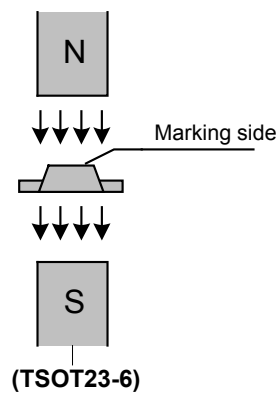
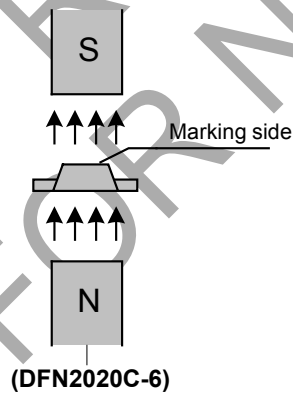
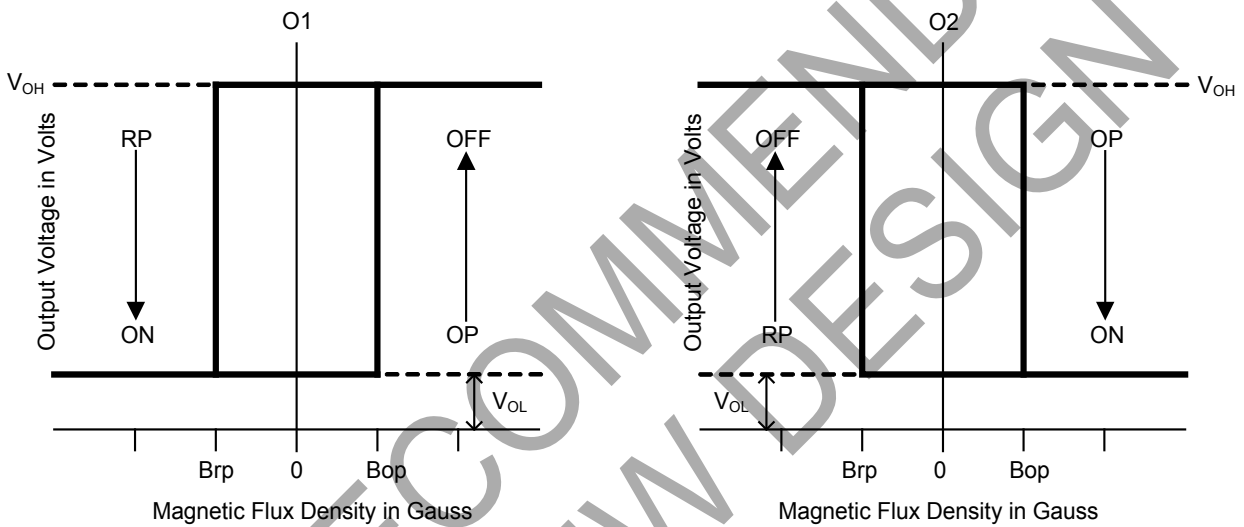

Operating Characteristics (cont. Note 7, 8, 9 and 10)

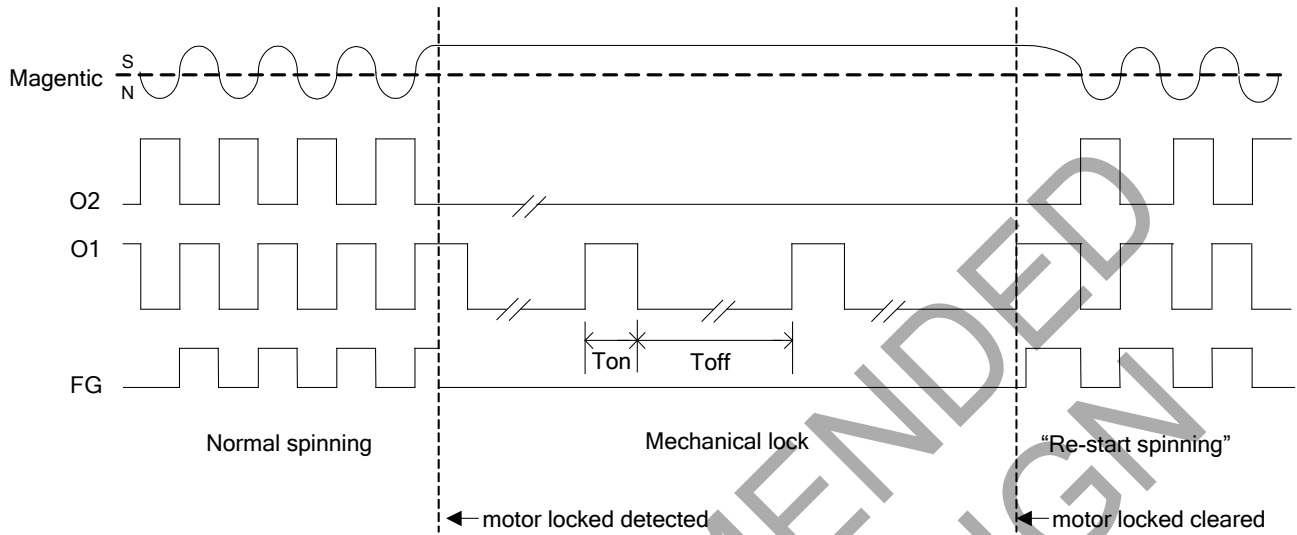

Truth Table

O1	O2	PWM	FG
L	H	H	L
H	L	H	H
L	L	L	X (Note 10)

- Notes:
- In "Normal spinning, the FG changes its state at each edge of O1.
 - When the motor locks with South pole at the Hall element, O2 is kept on "L" and O1 is a clock with Ton/Toff ratio. When motor locks with North pole at the Hall element, O1 is kept on "L", O2 is a clock with Ton/Toff ratio.
 - When "Re-start spinning" occurs, the motor speed ramps up to the "Normal Spinning" speed from zero. Speed ramp-up profile depends on motor characteristics.
 - X: H or L depends on magnetic pole north or South

NOT RECOMMENDED FOR NEW DESIGN

Application Note

DC Supply voltage speed control

Motor speed can be controlled by varying the Vdd supply voltage while PWM pin is tied to Vdd pin.

For example, with 5V nominal motor, changing supply voltage between 5V to 1.8V, speed can be reduced from 100% to 36% typically.

PWM speed control

Motor speed can also be adjusted by applying a PWM speed control signal into the PWM pin while keeping the Vdd pin at nominal motor voltage. The motor speed is proportional to the PWM signal duty. For example, with 5V nominal motor, Vdd pin is maintained at 5V typical while varying the PWM control signal duty to adjust the motor speed linearly. Figure below shows the output O1 and O2 in relation to PWM speed control signal at PWM pin.

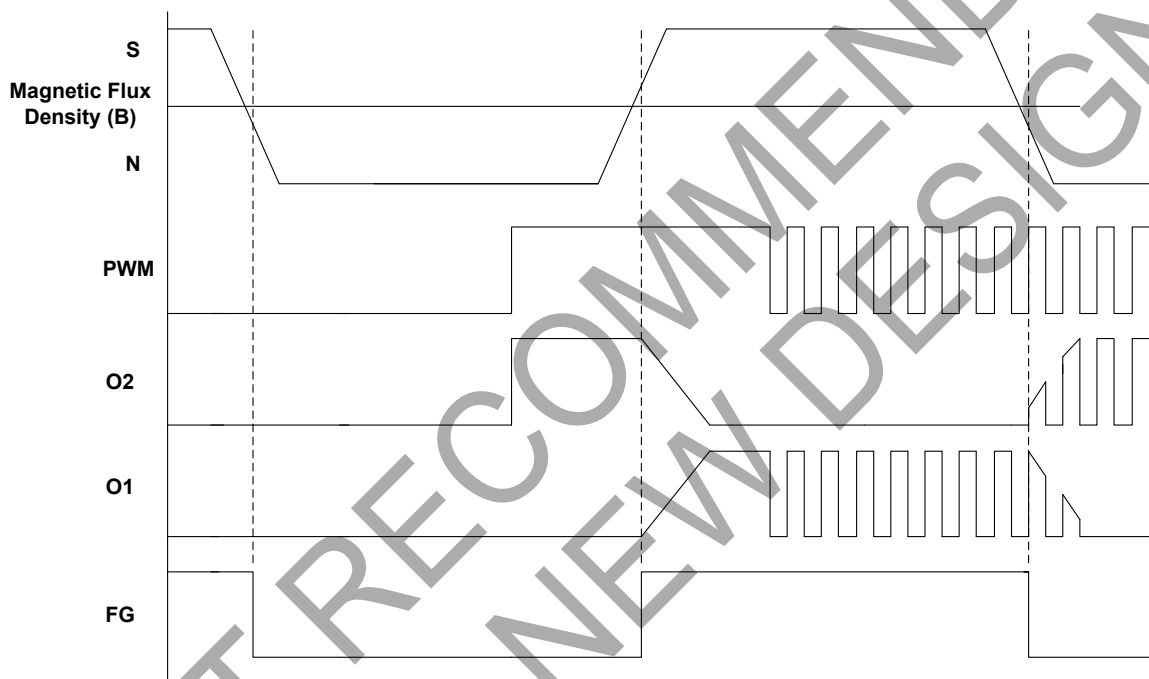

Frequency of PWM speed control signal can be between 15Hz to 50kHz. Recommended typical PWM signal frequency is 25kHz to keep switching frequency away from audible band. If PWM signal level at PWM pin stays low for longer than 65ms typical, the outputs are disabled.

Depending on the motor design and its inertia, minimum start-up PWM duty required can be typically between 30% - 40% while minimum running PWM duty can be down to 20%-25% typical. If voltage at Vdd is lower than the nominal motor voltage, both start-up PWM duty and minimum running PWM duty required will be higher.

Application Note (cont.)

Rotor lock Toff and PWM signal

When PWM signal input at PWM pin is low for longer than 65ms, internal rotor lock protection Toff is cleared. This allows the device to enter motor start Ton time on the next PWM high signal

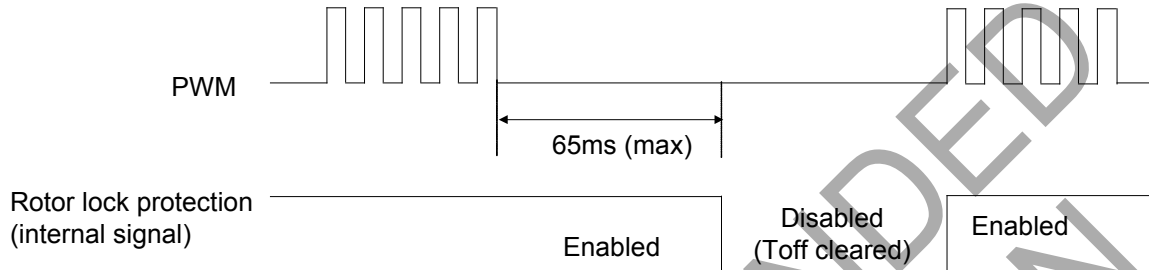

Soft Switching

AH5795 uses soft switching of the motor coil current during commutation for to minimize audible switching noise and electromagnetic interference (EMI) to provide a low noise solution.

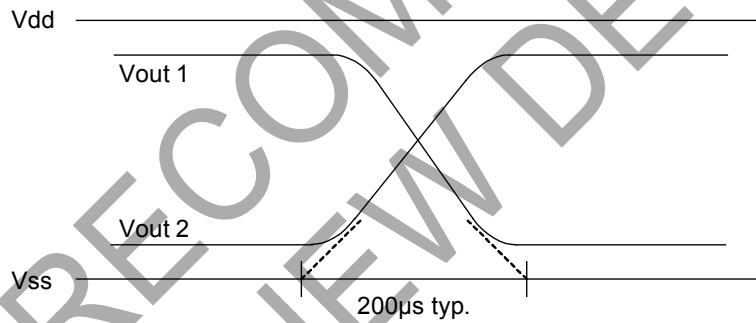

NOT RECOMMENDED FOR NEW DESIGN

Thermal Performance Characteristics

(1) TSOT23-6

T_A (°C)	25	50	60	70	75	80	85	90	95	100
P_D (mW)	651	521	469	417	391	365	339	313	286	260
T_A (°C)	105	110	115	120	125	130	135	140	145	150
P_D (mW)	234	208	182	156	130	104	78	52	26	0

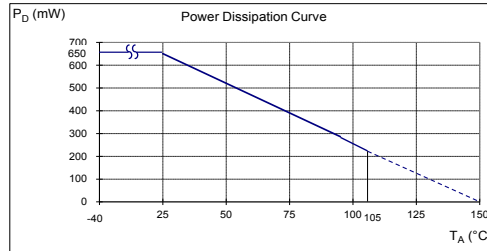

(2) DFN2020C-6 (Note 11)

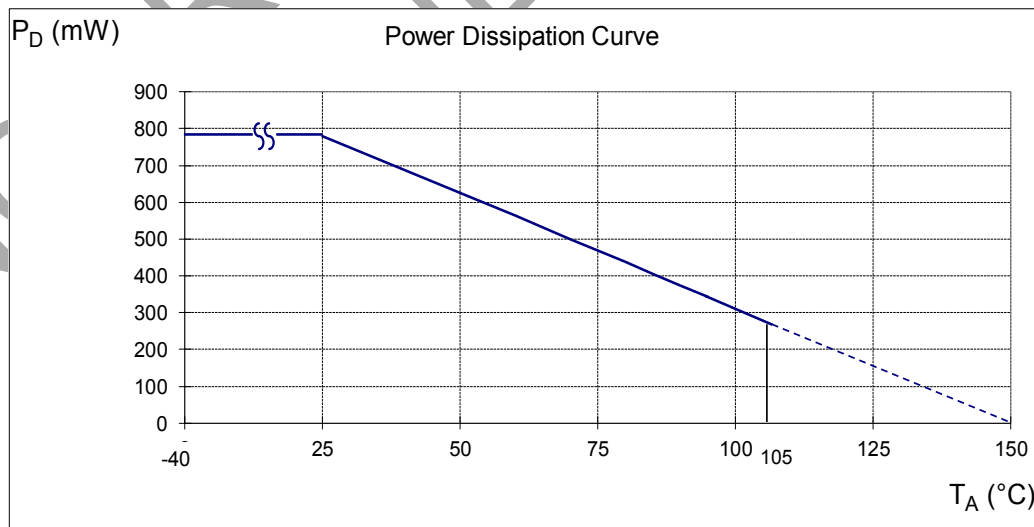

T_A (°C)	25	50	60	70	75	80	85	90	95	100
P_D (mW)	781	625	563	500	469	438	406	375	344	313
T_A (°C)	105	110	115	120	125	130	135	140	145	150
P_D (mW)	281	250	219	188	156	125	94	63	31	0

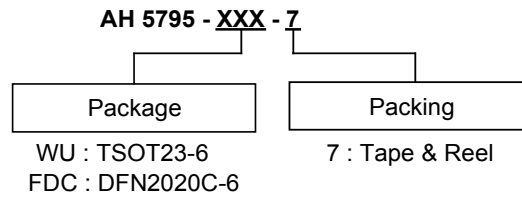

Notes: 11. DFN2020C-6 exposed pad soldered to minimum recommended landing pads (see Package Outline Dimension section) on a two-layer 2oz. copper FR4 PCB (1.6mm thickness) with no thermal vias in exposed PADS or any copper flood connecting to the landing pattern of the exposed pad.

Ordering information



Device	Package Code	Packaging (Note 12 & 13)	7" Tape and Reel	
			Quantity	Part Number Suffix
 AH5795-WU-7	WU	TSOT23-6	3000/Tape & Reel	-7
 AH5795-FDC-7	FDC	DFN2020C-6	3000/Tape & Reel	-7

Notes: 12. Pad layout as shown on Diodes Inc. suggested pad layout document AP02001, which can be found on our website at <http://www.diodes.com/datasheets/ap02001.pdf>
 13. EU Directive 2002/95/EC (RoHS). All applicable RoHS exemptions applied. Please visit our website at http://www.diodes.com/products/lead_free.html

Marking Information

(1) TSOT23-6

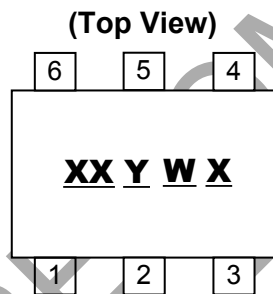

XX : Identification code
Y : Year 0~9
W : Week : A~Z : 1~26 week;
 a~z : 27~52 week;
 z represents 52 and 53 week
X : Internal code

Part Number	Package	Identification Code
AH5795-WU-7	TSOT23-6	J5

(2) DFN2020C-6

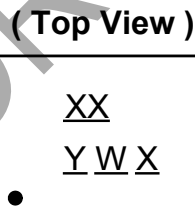

XX : Identification Code
Y : Year : 0~9
W : Week : A~Z : 1~26 week;
 a~z : 27~52 week; z represents 52 and 53 week
X : Internal code

Part Number	Package	Identification Code
AH5795-FDC-7	DFN2020C-6	J5

Package Outline Dimensions (All Dimensions in mm)

(1) Package type: TSOT23-6

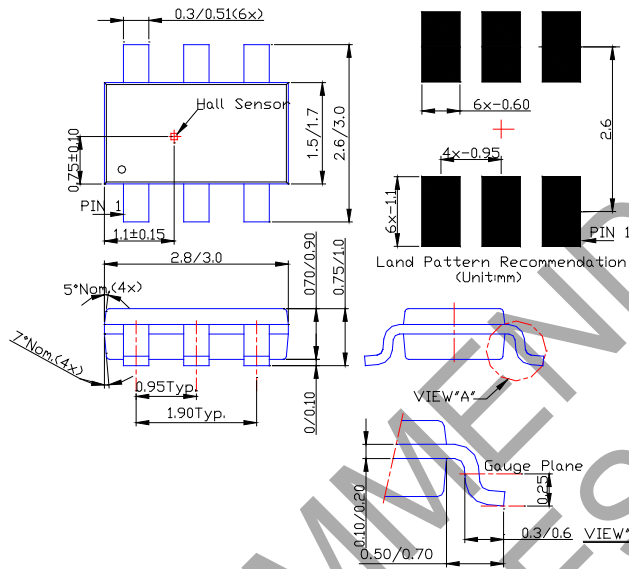

(2) Package Type: DFN2020C-6

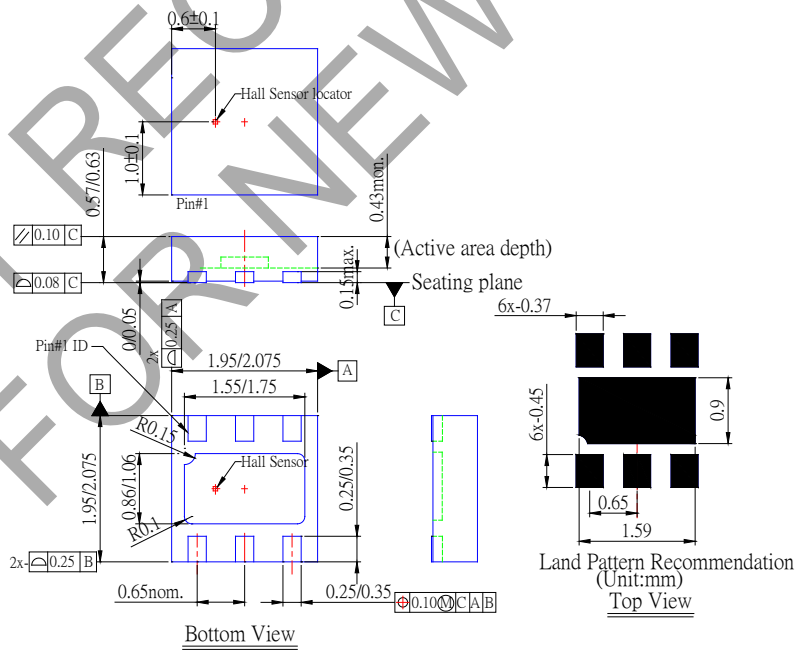

Taping Orientation

For DFN2020C-6

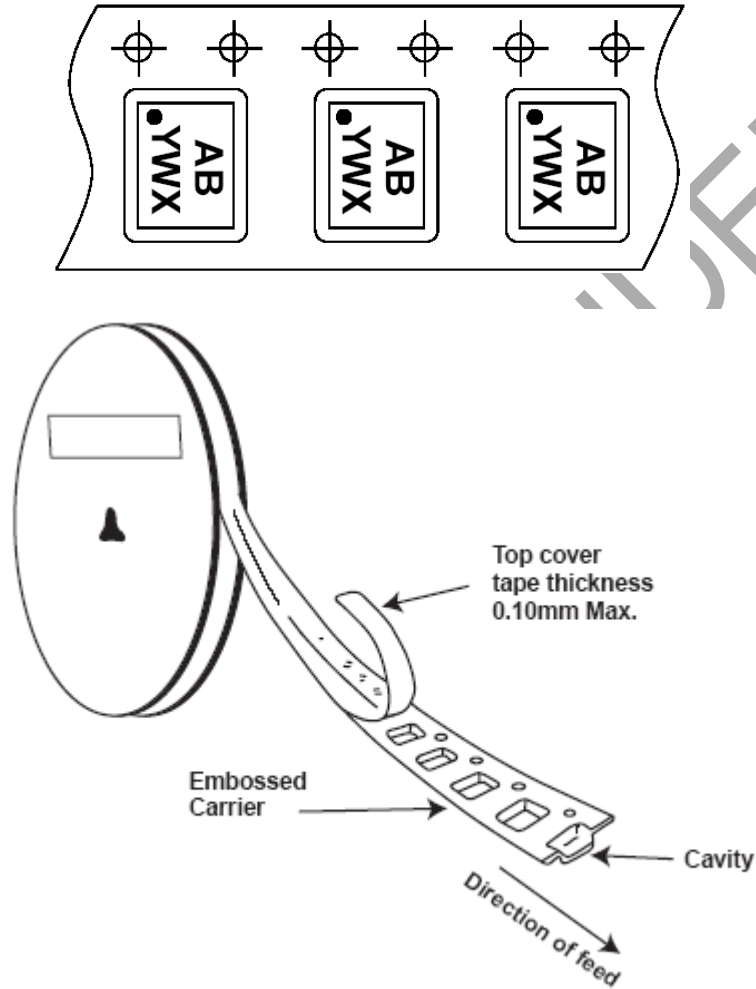

Notes: 14. The taping orientation of the other package type can be found on our website at <http://www.diodes.com/datasheets/ap02007.pdf>.

SINGLE PHASE HALL EFFECT LATCH FAN MOTOR DRIVER**IMPORTANT NOTICE**

1. DIODES INCORPORATED AND ITS SUBSIDIARIES (“DIODES”) MAKE NO WARRANTY OF ANY KIND, EXPRESS OR IMPLIED, WITH REGARDS TO ANY INFORMATION CONTAINED IN THIS DOCUMENT, INCLUDING, BUT NOT LIMITED TO, THE IMPLIED WARRANTIES OF MERCHANTABILITY, FITNESS FOR A PARTICULAR PURPOSE OR NON-INFRINGEMENT OF THIRD PARTY INTELLECTUAL PROPERTY RIGHTS (AND THEIR EQUIVALENTS UNDER THE LAWS OF ANY JURISDICTION).
2. The Information contained herein is for informational purpose only and is provided only to illustrate the operation of Diodes products described herein and application examples. Diodes does not assume any liability arising out of the application or use of this document or any product described herein. This document is intended for skilled and technically trained engineering customers and users who design with Diodes products. Diodes products may be used to facilitate safety-related applications; however, in all instances customers and users are responsible for (a) selecting the appropriate Diodes products for their applications, (b) evaluating the suitability of the Diodes products for their intended applications, (c) ensuring their applications, which incorporate Diodes products, comply the applicable legal and regulatory requirements as well as safety and functional-safety related standards, and (d) ensuring they design with appropriate safeguards (including testing, validation, quality control techniques, redundancy, malfunction prevention, and appropriate treatment for aging degradation) to minimize the risks associated with their applications.
3. Diodes assumes no liability for any application-related information, support, assistance or feedback that may be provided by Diodes from time to time. Any customer or user of this document or products described herein will assume all risks and liabilities associated with such use, and will hold Diodes and all companies whose products are represented herein or on Diodes’ websites, harmless against all damages and liabilities.
4. Products described herein may be covered by one or more United States, international or foreign patents and pending patent applications. Product names and markings noted herein may also be covered by one or more United States, international or foreign trademarks and trademark applications. Diodes does not convey any license under any of its intellectual property rights or the rights of any third parties (including third parties whose products and services may be described in this document or on Diodes’ website) under this document.
5. Diodes products are provided subject to Diodes’ Standard Terms and Conditions of Sale (<https://www.diodes.com/about/company/terms-and-conditions/terms-and-conditions-of-sales/>) or other applicable terms. This document does not alter or expand the applicable warranties provided by Diodes. Diodes does not warrant or accept any liability whatsoever in respect of any products purchased through unauthorized sales channel.
6. Diodes products and technology may not be used for or incorporated into any products or systems whose manufacture, use or sale is prohibited under any applicable laws and regulations. Should customers or users use Diodes products in contravention of any applicable laws or regulations, or for any unintended or unauthorized application, customers and users will (a) be solely responsible for any damages, losses or penalties arising in connection therewith or as a result thereof, and (b) indemnify and hold Diodes and its representatives and agents harmless against any and all claims, damages, expenses, and attorney fees arising out of, directly or indirectly, any claim relating to any noncompliance with the applicable laws and regulations, as well as any unintended or unauthorized application.
7. While efforts have been made to ensure the information contained in this document is accurate, complete and current, it may contain technical inaccuracies, omissions and typographical errors. Diodes does not warrant that information contained in this document is error-free and Diodes is under no obligation to update or otherwise correct this information. Notwithstanding the foregoing, Diodes reserves the right to make modifications, enhancements, improvements, corrections or other changes without further notice to this document and any product described herein. This document is written in English but may be translated into multiple languages for reference. Only the English version of this document is the final and determinative format released by Diodes.
8. Any unauthorized copying, modification, distribution, transmission, display or other use of this document (or any portion hereof) is prohibited. Diodes assumes no responsibility for any losses incurred by the customers or users or any third parties arising from any such unauthorized use.

Copyright © 2021 Diodes Incorporated

www.diodes.com

X-ON Electronics

Largest Supplier of Electrical and Electronic Components

Click to view similar products for [Motor/Motion/Ignition Controllers & Drivers](#) category:

Click to view products by [Diodes Incorporated](#) manufacturer:

Other Similar products are found below :

[FSB50550TB2](#) [FSBF15CH60BTH](#) [MSVGW45-14-2](#) [MSVGW54-14-3](#) [MSVGW54-14-5](#) [NTE7043](#) [LA6565VR-TLM-E](#) [LB11650-E](#)
[LB1837M-TLM-E](#) [LB1845DAZ-XE](#) [LC898300XA-MH](#) [SS30-TE-L-E](#) [26700](#) [LV8281VR-TLM-H](#) [BA5839FP-E2](#) [IRAM236-1067A](#)
[LA6584JA-AH](#) [LB11847L-E](#) [NCV70501DW002R2G](#) [STK672-630CN-E](#) [TND315S-TL-2H](#) [FNA23060](#) [FSB50250AB](#) [FNA41060](#) [MSVB54](#)
[MSVBTC50E](#) [MSVCPM4-63-12](#) [MSVTA120](#) [FSB50550AB](#) [NCV70501DW002G](#) [LC898301XA-MH](#) [LV8413GP-TE-L-E](#) [MSVGW45-14-3](#)
[MSVGW45-14-4](#) [MSVGW45-14-5](#) [MSVGW54-14-4](#) [STK984-091A-E](#) [SLA7026M](#) [MP6519GQ-Z](#) [LB11651-E](#) [IRSM515-025DA4](#)
[LV8127T-TLM-H](#) [NCP81382MNTXG](#) [TDA21801](#) [LB11851FA-BH](#) [NCV70627DQ001R2G](#) [LB1938FAGEVB](#) [IGCM04G60GAXKMA1](#)
[IKCM15H60HA](#) [TB6569FTG,8,EL](#)